

Insulation coordination for equipment within low-voltage systems —

Part 1: Principles, requirements and
tests

<http://www.cams-na-gauges.com/>

The European Standard EN 60664-1:2007 has the status of a
British Standard

ICS 29.080.30

National foreword

This British Standard is the UK implementation of EN 60664-1:2007. It is identical to IEC 60664-1:2007. It supersedes BS EN 60664-1:2003 which is withdrawn.

The UK participation in its preparation was entrusted to Technical Committee GEL/109, Insulation co-ordination for low voltage equipment.

A list of organizations represented on this committee can be obtained on request to its secretary.

This publication does not purport to include all the necessary provisions of a contract. Users are responsible for its correct application.

Compliance with a British Standard cannot confer immunity from legal obligations.

<http://www.china-gauges.com/>

This British Standard was published under the authority of the Standards Policy and Strategy Committee on 31 August 2007

© BSI 2007

ISBN 978 0 580 54335 7

Amendments issued since publication

Amd. No.	Date	Comments

English version

**Insulation coordination for equipment
within low-voltage systems -
Part 1: Principles, requirements and tests**
(IEC 60664-1:2007)

Coordination de l'isolement
des matériels dans les systèmes
(réseaux) à basse tension -
Partie 1: Principes, exigences
et essais
(CEI 60664-1:2007)

Isolationskoordination
für elektrische Betriebsmittel
in Niederspannungsanlagen -
Teil 1: Grundsätze, Anforderungen
und Prüfungen
(IEC 60664-1:2007)

This European Standard was approved by CENELEC on 2007-07-01. CENELEC members are bound to comply with the CEN/CENELEC Internal Regulations which stipulate the conditions for giving this European Standard the status of a national standard without any alteration.

Up-to-date lists and bibliographical references concerning such national standards may be obtained on application to the Central Secretariat or to any CENELEC member.

This European Standard exists in three official versions (English, French, German). A version in any other language made by translation under the responsibility of a CENELEC member into its own language and notified to the Central Secretariat has the same status as the official versions.

CENELEC members are the national electrotechnical committees of Austria, Belgium, Bulgaria, Cyprus, the Czech Republic, Denmark, Estonia, Finland, France, Germany, Greece, Hungary, Iceland, Ireland, Italy, Latvia, Lithuania, Luxembourg, Malta, the Netherlands, Norway, Poland, Portugal, Romania, Slovakia, Slovenia, Spain, Sweden, Switzerland and the United Kingdom.

CENELEC

European Committee for Electrotechnical Standardization
Comité Européen de Normalisation Electrotechnique
Europäisches Komitee für Elektrotechnische Normung

Central Secretariat: rue de Stassart 35, B - 1050 Brussels

Foreword

The text of document 109/58/CDV, future edition 2 of IEC 60664-1, prepared by IEC TC 109, Insulation co-ordination for low-voltage equipment, was submitted to the IEC-CENELEC parallel Unique Acceptance Procedure and was approved by CENELEC as EN 60664-1 on 2007-07-01.

This European Standard supersedes EN 60664-1:2003.

In addition to a number of editorial improvements, the following main changes have been made with respect to EN 60664-1:2003:

- amendment of Japanese mains conditions with regard to the rated impulse voltages, the rationalized voltages and the nominal voltages of supply systems for different modes of overvoltage control;
- amendment of dimensioning of clearances smaller than 0,01 mm;
- alignment of the table and the corresponding formula regarding test voltages for verifying clearances at different altitudes;
- amendment of interpolation of the creepage distance values for functional insulation;
- amendment of creepage distance dimensioning taking into account ribs;
- revision of the former Clause 4 "Tests and measurements" (now Clause 6) to achieve a more detailed description of the tests and their purpose, the test equipment and possible alternatives;
- change of Annex C "Partial discharge test methods" from a former technical report, Type 2 (now called TS), to a normative Annex C.

The following dates were fixed:

- | | | |
|--|-------|------------|
| – latest date by which the EN has to be implemented at national level by publication of an identical national standard or by endorsement | (dop) | 2008-04-01 |
| – latest date by which the national standards conflicting with the EN have to be withdrawn | (dow) | 2010-07-01 |

Annex ZA has been added by CENELEC.

Endorsement notice

The text of the International Standard IEC 60664-1:2007 was approved by CENELEC as a European Standard without any modification.

CONTENTS

1	Scope and object.....	6
2	Normative references	6
3	Terms and definitions	8
4	Basis for insulation coordination	13
4.1	General	13
4.2	Insulation coordination with regard to voltage	13
4.2.1	General	13
4.2.2	Insulation coordination with regard to long-term a.c. or d.c. voltages	14
4.2.3	Insulation coordination with regard to transient overvoltage	14
4.2.4	Insulation coordination with regard to recurring peak voltage	14
4.2.5	Insulation coordination with regard to temporary overvoltage	14
4.2.6	Insulation coordination with regard to environmental conditions	15
4.3	Voltages and voltage ratings	15
4.3.1	General	15
4.3.2	Determination of voltage for long-term stresses	15
4.3.3	Determination of rated impulse voltage	16
4.3.4	Determination of recurring peak voltage	18
4.3.5	Determination of temporary overvoltage	18
4.4	Frequency	19
4.5	Time under voltage stress	19
4.6	Pollution	19
4.6.1	General	19
4.6.2	Degrees of pollution in the micro-environment	20
4.6.3	Conditions of conductive pollution	20
4.7	Information supplied with the equipment	20
4.8	Insulating material	20
4.8.1	Comparative tracking index (CTI)	20
4.8.2	Electric strength characteristics	21
4.8.3	Thermal characteristics	21
4.8.4	Mechanical and chemical characteristics	21
5	Requirements and dimensioning rules	22
5.1	Dimensioning of clearances	22
5.1.1	General	22
5.1.2	Dimensioning criteria	22
5.1.3	Electric field conditions	23
5.1.4	Altitude	23
5.1.5	Dimensioning of clearances of functional insulation	23
5.1.6	Dimensioning of clearances of basic, supplementary and reinforced insulation	23
5.1.7	Isolating distances	24
5.2	Dimensioning of creepage distances	24
5.2.1	General	24
5.2.2	Influencing factors	24
5.2.3	Dimensioning of creepage distances of functional insulation	26
5.2.4	Dimensioning of creepage distances of basic, supplementary and reinforced insulation	26
5.2.5	Reduction of creepage distances with the use of a rib (ribs)	26

5.3	Requirements for design of solid insulation	27
5.3.1	General	27
5.3.2	Stresses	27
5.3.3	Requirements	27
6	Tests and measurements	31
6.1	Tests	31
6.1.1	General	31
6.1.2	Test for verification of clearances	32
6.1.3	Tests for the verification of solid insulation	35
6.1.4	Performing dielectric tests on complete equipment	40
6.1.5	Other tests	41
6.1.6	Measurement accuracy of test parameters	41
6.2	Measurement of creepage distances and clearances	42
	Annex A (informative) Basic data on withstand characteristics of clearances	47
	Annex B (informative) Nominal voltages of supply systems for different modes of overvoltage control	52
	Annex C (normative) Partial discharge test methods	54
	Annex D (informative) Additional information on partial discharge test methods	59
	Annex E (informative) Comparison of creepage distances specified in Table F.4 and clearances in Table A.1	62
	Annex F (normative) Tables	63
	Annex ZA (normative) Normative references to international publications with their corresponding European publications	73
	Bibliography	72
	Figure 1 – Recurring peak voltage	18
	Figure 2 – Determination of the width (W) and height (H) of a rib	27
	Figure 3 – Test voltages	39
	Figure A.1 – Withstand voltage at 2 000 m above sea level	49
	Figure A.2 – Experimental data measured at approximately sea level and their low limits for inhomogeneous field	50
	Figure A.3 – Experimental data measured at approximately sea level and their low limits for homogeneous field	51
	Figure C.1 – Earthed test specimen	54
	Figure C.2 – Unearthed test specimen	54
	Figure C.3 – Calibration for earthed test specimen	57
	Figure C.4 – Calibration for unearthed test specimen	57
	Figure D.1 – Partial discharge test circuits	59

Figure E.1 – Comparison of creepage distances specified in Table F.4 and clearances in Table A.1 62

Table A.1 – Withstand voltages in kilovolts for an altitude of 2 000 m above sea level 47

Table A.2 – Altitude correction factors 48

Table B.1 – Inherent control or equivalent protective control 52

Table B.2 – Cases where protective control is necessary and control provided by surge arresters having a ratio of clamping voltage to rated voltage not smaller than that specified by IEC 60099-1 53

Table F.1 – Rated impulse voltage for equipment energized directly from the low-voltage mains 63

Table F.2 – Clearances to withstand transient overvoltages 64

Table F.3a – Single-phase three- or two-wire a.c. or d.c. systems 65

Table F.3b – Three-phase four or three-wire a.c. systems 66

Table F.4 – Creepage distances to avoid failure due to tracking 67

Table F.5 – Test voltages for verifying clearances at different altitudes 69

Table F.6 – Severities for conditioning of solid insulation 69

Table F.7 – Clearances to withstand steady-state voltages, temporary overvoltages or recurring peak voltages 70

Table F.7a – Dimensioning of clearances to withstand steady-state voltages, temporary overvoltages or recurring peak voltages 70

Table F.7b – Additional information concerning the dimensioning of clearances to avoid partial discharge 70

Table F.8 – Altitude correction factors 71

<http://www.china-gauges.com/>

INSULATION COORDINATION FOR EQUIPMENT WITHIN LOW-VOLTAGE SYSTEMS –

Part 1: Principles, requirements and tests

1 Scope and object

This part of IEC 60664 deals with insulation coordination for equipment within low-voltage systems. It applies to equipment for use up to 2 000 m above sea level having a rated voltage up to a.c. 1 000 V with rated frequencies up to 30 kHz, or a rated voltage up to d.c. 1 500 V.

It specifies the requirements for clearances, creepage distances and solid insulation for equipment based upon their performance criteria. It includes methods of electric testing with respect to insulation coordination.

The minimum clearances specified in this standard do not apply where ionized gases occur. Special requirements for such situations may be specified at the discretion of the relevant technical committee.

This standard does not deal with distances

- through liquid insulation,
- through gases other than air,
- through compressed air.

NOTE 1 Insulation coordination for equipment within low-voltage systems with rated frequencies above 30 kHz is given in IEC 60664-4.

NOTE 2 Higher voltages may exist in internal circuits of the equipment.

NOTE 3 Guidance for dimensioning for altitudes exceeding 2 000 m is given in Table A.2.

The object of this basic safety standard is to guide technical committees responsible for different equipment in order to rationalize their requirements so that insulation coordination is achieved.

It provides the information necessary to give guidance to technical committees when specifying clearances in air, creepage distances and solid insulation for equipment.

Care should be taken to see that manufacturers and technical committees are responsible for application of the requirements, as specified in this basic safety publication, or make reference to it, where necessary, in standards for equipment within their scope.

In the case of missing specified values for clearances, creepage distances and requirements for solid insulation in the relevant product standards, or even missing standards, this standard is applicable.

2 Normative references

The following referenced documents are indispensable for the application of this document. For dated references, only the edition cited applies. For undated references, the latest edition of the referenced document (including any amendments) applies.

IEC 60038:1983, *IEC standard voltages*

IEC 60050(151):2001, *International Electrotechnical Vocabulary (IEV) – Chapter 151: Electrical and magnetic devices*

IEC 60050(212):1990, *International Electrotechnical Vocabulary – Chapter 212: Insulating solids, liquids and gases*

IEC 60050(604):1987, *International Electrotechnical Vocabulary (IEV) – Chapter 604: Generation, transmission and distribution of electricity – Operation*
Amendment 1 (1998)

IEC 60050(826):2004, *International Electrotechnical Vocabulary (IEV) – Part 826: Electrical installations*

IEC 60068-1:1988, *Environmental testing – Part 1: General and guidance*

IEC 60068-2-2:1974, *Environmental testing – Part 2: Tests – Tests B: Dry heat*

IEC 60068-2-14:1984, *Environmental testing – Part 2: Tests – Test N: Change of temperature*

IEC 60068-2-78:2001, *Environmental testing – Part 2-78: Tests – Test Cab: Damp heat, steady state*

IEC 60085:2004, *Electrical insulation – Thermal classification*

IEC 60099-1:1991, *Surge arresters – Part 1: Non-linear resistor type gapped surge arresters for a.c. systems*

IEC 60112:2003, *Method for the determination of the proof and the comparative tracking indices of solid insulating materials*

IEC 60216, (all parts) *Electrical insulating materials – Properties for thermal endurance*

IEC 60243-1:1998, *Electrical strength of insulating materials – Test methods – Part 1: Tests at power frequencies*

IEC 60270:2000, *High-voltage test techniques – Partial discharge measurements*

IEC 60364-4-44:2001, *Electrical installations of buildings – Part 4-44: Protection for safety – Protection against voltage disturbances and electromagnetic disturbances*
Amendment 1 (2003)

IEC 60664-4:2005, *Insulation coordination for equipment within low-voltage systems – Part 4: Consideration of high-frequency voltage stress*

IEC 60664-5, *Insulation coordination for equipment within low-voltage systems – Part 5: A comprehensive method for determining clearances and creepage distances equal to or less than 2 mm¹*

IEC 61140:2001, *Protection against electric shock – Common aspects for installation and equipment*
Amendment 1 (2004)

IEC 61180-1:1992, *High-voltage test techniques for low-voltage equipment – Part 1: Definitions, test and procedure requirements*

¹ A second edition of IEC 60664-5 will be published shortly.

IEC 61180-2:1994, *High-voltage test techniques for low-voltage equipment – Part 2: Test equipment*

IEC Guide 104:1997, *The preparation of safety publications and the use of basic safety publications and group safety publications*

3 Terms and definitions

For the purposes of this document, the following definitions apply.

3.1

insulation coordination

mutual correlation of insulation characteristics of electrical equipment taking into account the expected micro-environment and other influencing stresses

NOTE Expected voltage stresses are characterized in terms of the characteristics defined in 3.5 to 3.7.

3.2

clearance

shortest distance in air between two conductive parts

3.3

creepage distance

shortest distance along the surface of a solid insulating material between two conductive parts

(IEV 151-15-50)

3.4

solid insulation

solid insulating material interposed between two conductive parts

3.5

working voltage

highest r.m.s. value of the a.c. or d.c. voltage across any particular insulation which can occur when the equipment is supplied at rated voltage

NOTE 1 Transients are disregarded.

NOTE 2 Both open-circuit conditions and normal operating conditions are taken into account.

3.6

recurring peak voltage

U_{rp}

maximum peak value of periodic excursions of the voltage waveform resulting from distortions of an a.c. voltage or from a.c. components superimposed on a d.c. voltage

NOTE Random overvoltages, for example due to occasional switching, are not considered to be recurring peak voltages.

3.7

overvoltage

any voltage having a peak value exceeding the corresponding peak value of maximum steady-state voltage at normal operating conditions

3.7.1

temporary overvoltage

overvoltage at power frequency of relatively long duration

3.7.2

transient overvoltage

short duration overvoltage of a few milliseconds or less, oscillatory or non-oscillatory, usually highly damped

(IEV 604-03-13)

3.7.3

switching overvoltage

transient overvoltage at any point of the system due to specific switching operation or fault

3.7.4

lightning overvoltage

transient overvoltage at any point of the system due to a specific lightning discharge

3.7.5

functional overvoltage

deliberately imposed overvoltage necessary for the function of a device

3.8

withstand voltage

voltage to be applied to a specimen under prescribed test conditions which does not cause breakdown and/or flashover of a satisfactory specimen

(IEV 212-01-31)

3.8.1

impulse withstand voltage

highest peak value of impulse voltage of prescribed form and polarity which does not cause breakdown of insulation under specified conditions

3.8.2

r.m.s. withstand voltage

highest r.m.s. value of a voltage which does not cause breakdown of insulation under specified conditions

3.8.3

recurring peak withstand voltage

highest peak value of a recurring voltage which does not cause breakdown of insulation under specified conditions

3.8.4

temporary withstand overvoltage

highest r.m.s. value of a temporary overvoltage which does not cause breakdown of insulation under specified conditions

3.9

rated voltage

value of voltage assigned by the manufacturer, to a component, device or equipment and to which operation and performance characteristics are referred

NOTE Equipment may have more than one rated voltage value or may have a rated voltage range.

3.9.1

rated insulation voltage

r.m.s. withstand voltage value assigned by the manufacturer to the equipment or to a part of it, characterizing the specified (long-term) withstand capability of its insulation

NOTE The rated insulation voltage is not necessarily equal to the rated voltage of equipment which is primarily

related to functional performance.

3.9.2

rated impulse voltage

impulse withstand voltage value assigned by the manufacturer to the equipment or to a part of it, characterizing the specified withstand capability of its insulation against transient overvoltages

3.9.3

rated recurring peak voltage

recurring peak withstand voltage value assigned by the manufacturer to the equipment or to a part of it, characterizing the specified withstand capability of its insulation against recurring peak voltages

3.9.4

rated temporary overvoltage

temporary withstand overvoltage value assigned by the manufacturer to the equipment, or to a part of it, characterizing the specified short-term withstand capability of its insulation against a.c. voltages

3.10

overvoltage category

numeral defining a transient overvoltage condition

NOTE 1 Overvoltage categories I, II, III and IV are used, see 4.3.3.2.

NOTE 2 The term 'overvoltage category' in this standard is synonymous with 'impulse withstand category' used in IEC 60364-4-44, Clause 443.

3.11

pollution

any addition of foreign matter, solid, liquid, or gaseous that can result in a reduction of electric strength or surface resistivity of the insulation

3.12

environment

surrounding which may affect performance of a device or system

NOTE Examples are pressure, temperature, humidity, pollution, radiation and vibration.

(IEV 151-16-03, modified)

3.12.1

macro-environment

environment of the room or other location in which the equipment is installed or used

3.12.2

micro-environment

immediate environment of the insulation which particularly influences the dimensioning of the creepage distances

3.13

pollution degree

numeral characterizing the expected pollution of the micro-environment

NOTE Pollution degrees 1, 2, 3 and 4 are established in 4.6.2.

3.14

homogeneous field

electric field which has an essentially constant voltage gradient between electrodes (uniform field), such as that between two spheres where the radius of each sphere is greater than the distance between them

NOTE The homogeneous field condition is referred to as case B.

3.15

inhomogeneous field

electric field which does not have an essentially constant voltage gradient between electrodes (non-uniform field)

NOTE The inhomogeneous field condition of a point-plane electrode configuration is the worst case with regard to voltage withstand capability and is referred to as case A. It is represented by a point electrode having a 30 µm radius and a plane of 1 m × 1 m.

3.16

controlled overvoltage condition

condition within an electrical system wherein the expected transient overvoltages are limited to a defined level

3.17

insulation

that part of an electrotechnical product which separates the conducting parts at different electrical potentials

(IEV 212-01-05)

3.17.1

functional insulation

insulation between conductive parts which is necessary only for the proper functioning of the equipment

3.17.2

basic insulation

insulation of hazardous-live-parts which provides basic protection

NOTE The concept does not apply to insulation used exclusively for functional purposes.

(IEV 826-12-14)

3.17.3

supplementary insulation

independent insulation applied in addition to basic insulation for fault protection

(IEV 826-12-15)

3.17.4

double insulation

insulation comprising both basic insulation and supplementary insulation

(IEV 826-12-16)

3.17.5

reinforced insulation

insulation of hazardous-live-parts which provides a degree of protection against electric shock equivalent to double insulation

NOTE Reinforced insulation may comprise several layers which cannot be tested singly as basic insulation or supplementary insulation.

(IEV 826-12-17)

3.18

partial discharge

PD

electric discharge that partially bridges the insulation

3.18.1 apparent charge

 q

electric charge which can be measured at the terminals of the specimen under test

NOTE 1 The apparent charge is smaller than the partial discharge.

NOTE 2 The measurement of the apparent charge requires a short-circuit condition at the terminals of the specimen (see Clause D.2) under test.

3.18.2 specified discharge magnitude

magnitude of the apparent charge which is regarded as the limiting value according to the objective of this standard

NOTE The pulse with the maximum amplitude should be evaluated.

3.18.3 pulse repetition rate

average number of pulses per second with an apparent charge higher than the detection level

NOTE Within the scope of this standard it is not permitted to weigh discharge magnitudes according to the pulse repetition rate.

3.18.4 partial discharge inception voltage

 U_i

lowest peak value of the test voltage at which the apparent charge becomes greater than the specified discharge magnitude when the test voltage is increased above a low value for which no discharge occurs

NOTE For a.c. tests the r.m.s. value may be used.

3.18.5 partial discharge extinction voltage

 U_e

lowest peak value of the test voltage at which the apparent charge becomes less than the specified discharge magnitude when the test voltage is reduced below a high level where such discharges have occurred

NOTE For a.c. tests the r.m.s. value may be used.

3.18.6 partial discharge test voltage

 U_t

peak value of the test voltage for the procedure of 6.1.3.5.3 where the apparent charge is less than the specified discharge magnitude

NOTE For a.c. tests the r.m.s. value may be used.

3.19 test

technical operation that consists of the determination of one or more characteristics of a given product, process or service according to a specified procedure

(13.1 of ISO/IEC Guide 2:1996) ^[1]²

NOTE A test is carried out to measure or classify a characteristic or a property of an item by applying to the item a set of environmental and operating conditions and/or requirements.

² References in square brackets refer to the bibliography.

(IEV 151-16-13)

**3.19.1
type test**

test of one or more devices made to a certain design to show that the design meets certain specifications

**3.19.2
routine test**

test to which each individual device is subjected during or after manufacture to ascertain whether it complies with certain criteria

**3.19.3
sampling test**

test on a number of devices taken at random from a batch

**3.20
electrical breakdown**

failure of insulation under electric stress when the discharge completely bridges the insulation, thus reducing the voltage between the electrodes almost to zero

**3.20.1
sparkover**

electrical breakdown in a gaseous or liquid medium

**3.20.2
flashover**

electrical breakdown along a surface of solid insulation located in a gaseous or liquid medium

**3.20.3
puncture**

electrical breakdown through solid insulation

4 Basis for insulation coordination

4.1 General

Insulation coordination implies the selection of the electric insulation characteristics of the equipment with regard to its application and in relation to its surroundings.

Insulation coordination can only be achieved if the design of the equipment is based on the stresses to which it is likely to be subjected during its anticipated lifetime.

4.2 Insulation coordination with regard to voltage

4.2.1 General

Consideration shall be given to

- the voltages which can appear within the system,
- the voltages generated by the equipment (which could adversely affect other equipment in the system),
- the degree of continuity of service desired,
- the safety of persons and property, so that the probability of undesired incidents due to voltage stresses does not lead to an unacceptable risk of harm.

4.2.2 Insulation coordination with regard to long-term a.c. or d.c. voltages

Insulation coordination with regard to long-term voltages is based on

- rated voltage,
- rated insulation voltage,
- working voltage.

4.2.3 Insulation coordination with regard to transient overvoltage

Insulation coordination with regard to transient overvoltage is based on controlled overvoltage conditions. There are two kinds of control:

- inherent control: the condition within an electrical system wherein the characteristics of the system can be expected to limit the prospective transient overvoltages to a defined level;
- protective control: the condition within an electrical system wherein specific overvoltage attenuating means can be expected to limit the prospective transient overvoltages to a defined level.

NOTE 1 Overvoltages in large and complex systems, such as low-voltage mains subjected to multiple and variable influences, can only be assessed on a statistical basis. This is particularly true for overvoltages of atmospheric origin and applies whether the controlled condition is achieved as a consequence of inherent control or by means of protective control.

NOTE 2 A probabilistic analysis is recommended to assess whether inherent control exists or whether protective control is needed. This analysis requires knowledge of the electrical system characteristics, the ceramic levels, transient overvoltage levels, etc. This approach has been used in IEC 60364-4-44 for electrical installations of buildings connected to low-voltage mains.

NOTE 3 The specific overvoltage attenuating means may be a device having means for storage or dissipation of energy and, under defined conditions, capable of harmlessly dissipating the energy of the overvoltages expected at the location.

In order to apply the concept of insulation coordination, distinction is made between transient overvoltages from two different sources:

- transient overvoltages originating in the system to which the equipment is connected through its terminals;
- transient overvoltages originating in the equipment.

Insulation coordination uses a preferred series of values of rated impulse voltage:

330 V, 500 V, 800 V, 1 500 V, 2 500 V, 4 000 V, 6 000 V, 8 000 V, 12 000 V.

4.2.4 Insulation coordination with regard to recurring peak voltage

Consideration shall be given to the extent that partial discharges can occur in solid insulation (see 5.3.2.3.1) or along surfaces of insulation (see Table F.7b).

4.2.5 Insulation coordination with regard to temporary overvoltage

Insulation coordination with regard to temporary overvoltages is based on the temporary overvoltage specified in Clause 442 of IEC 60364-4-44 (see 5.3.3.2.3 of this standard).

NOTE Currently available surge protective devices (SPDs) are not able to adequately deal with the energy associated with temporary overvoltages.

4.2.6 Insulation coordination with regard to environmental conditions

The micro-environmental conditions for the insulation shall be taken into account as quantified by pollution degree.

Micro-environmental conditions depend primarily on the macro-environmental conditions in which the equipment is located and in many cases the environments are identical. However, the micro-environment can be better or worse than the macro-environment where, for example, enclosures, heating, ventilation or dust influence the micro-environment.

NOTE Protection by enclosures provided according to the classes specified in IEC 60529 [2] does not necessarily improve the micro-environment with regard to pollution.

The most important environmental parameters are as follows:

- for clearances:
 - air pressure,
 - temperature, if it has a wide variation;
- for creepage distances:
 - pollution,
 - relative humidity,
 - condensation;
- for solid insulation:
 - temperature,
 - relative humidity.

4.3 Voltages and voltage ratings

4.3.1 General

For the purpose of dimensioning equipment in accordance with insulation coordination, technical committees shall specify:

- the basis for voltage ratings;
- an overvoltage category according to the expected use of the equipment, taking into account the characteristics of the system to which it is intended to be connected.

4.3.2 Determination of voltage for long-term stresses

4.3.2.1 General

It is assumed that the rated voltage of equipment is not lower than the nominal voltage of the supply system.

4.3.2.2 Voltage for dimensioning basic insulation

4.3.2.2.1 Equipment energized directly from the low-voltage mains

The nominal voltages of the low-voltage mains have been rationalized according to Tables F.3a and F.3b (see 5.2.2.2) and these voltages are the minimum to be used for the selection of creepage distances. They may also be used for the selection of rated insulation voltages.

For equipment having several rated voltages so that it may be used at different nominal voltages of the low-voltage mains, the voltage selected shall be appropriate for the highest rated voltage of the equipment.

Technical committees shall consider whether the voltage is to be selected

- based on line-to-line voltage, or
- based on line-to-neutral voltage.

In the latter case the technical committee shall specify how the user is to be informed that the equipment is for use on neutral-earthed systems only.

4.3.2.2.2 Systems, equipment and internal circuits not energized directly from the low-voltage mains

The highest r.m.s. voltage which can occur in the system, equipment or internal circuits shall be used for basic insulation. The voltage is determined for supply at rated voltage and under the most onerous combination of other conditions within the rating of the equipment.

NOTE Fault conditions are not taken into account.

4.3.2.3 Voltage for dimensioning functional insulation

The working voltage is used for determining the dimensions required for functional insulation.

4.3.3 Determination of rated impulse voltage

4.3.3.1 General

The transient overvoltages are taken as the basis for determining the rated impulse voltage.

4.3.3.2 Overvoltage categories

4.3.3.2.1 General

The concept of overvoltage categories is used for equipment energized directly from the low-voltage mains.

The overvoltage categories have a probabilistic implication rather than the meaning of physical attenuation of the transient overvoltage downstream in the installation.

NOTE 1 This concept of overvoltage categories is used in Clause 443 of IEC 60364-4-44.

NOTE 2 The term 'overvoltage category' in this standard is synonymous with 'impulse withstand category' used in Clause 443 of IEC 60364-4-44.

A similar concept can also be used for equipment connected to other systems, for example telecommunication and data systems.

4.3.3.2.2 Equipment energized directly from the supply mains

Technical committees shall specify the overvoltage category as based on the following general explanation of overvoltage categories (see also Clause 443 of IEC 60364-4-44):

- Equipment of overvoltage category IV is for use at the origin of the installation.

NOTE 1 Examples of such equipment are electricity meters and primary overcurrent protection equipment.

- Equipment of overvoltage category III is equipment in fixed installations and for cases where the reliability and the availability of the equipment is subject to special requirements.

NOTE 2 Examples of such equipment are switches in the fixed installation and equipment for industrial use with permanent connection to the fixed installation.

- Equipment of overvoltage category II is energy-consuming equipment to be supplied from the fixed installation.

NOTE 3 Examples of such equipment are appliances, portable tools and other household and similar loads.

If such equipment is subjected to special requirements with regard to reliability and availability, overvoltage category III applies.

- Equipment of overvoltage category I is equipment for connection to circuits in which measures are taken to limit transient overvoltages to an appropriately low level.

These measures shall ensure that the temporary overvoltages that could occur are sufficiently limited so that their peak value does not exceed the relevant rated impulse voltage of Table F.1.

NOTE 4 Examples of such equipment are those containing electronic circuits protected to this level, however see the note in 4.2.5.

NOTE 5 Unless the circuits are designed to take the temporary overvoltages into account, equipment of overvoltage category 1 cannot be directly connected to the supply mains.

4.3.3.2.3 Systems and equipment not energized directly from the low-voltage mains

It is recommended that technical committees specify overvoltage categories or rated impulse voltages as appropriate. Application of the preferred series of 4.2.3 is recommended.

NOTE Telecommunication or industrial control systems or independent systems on vehicles are examples of such systems.

4.3.3.3 Selection of rated impulse voltage for equipment

The rated impulse voltage of the equipment shall be selected from Table F.1 corresponding to the overvoltage category specified and to the rated voltage of the equipment.

NOTE 1 Equipment with a particular rated impulse voltage and having more than one rated voltage may be suitable for use in different overvoltage categories.

NOTE 2 For consideration of the switching overvoltage aspect, see 4.3.3.5.

4.3.3.4 Impulse voltage insulation coordination within equipment

4.3.3.4.1 Parts or circuits within equipment significantly influenced by external transient overvoltages

The rated impulse voltage of the equipment applies. Transient overvoltages which can be generated by the operation of the equipment shall not influence external circuit conditions beyond that specified in 4.3.3.5.

4.3.3.4.2 Parts or circuits within equipment specifically protected against transient overvoltages

For such parts that are not significantly influenced by external transient overvoltages, the impulse withstand voltage required for basic insulation is not related to the rated impulse voltage of the equipment but to the actual conditions for that part or circuit. Application of the preferred series of impulse voltage values as introduced in 4.2.3 is, however, recommended to permit standardization. In other cases, interpolation of Table F.2 values is allowed.

4.3.3.5 Switching overvoltage generated by the equipment

For equipment capable of generating an overvoltage at the equipment terminals, for example switching devices, the rated impulse voltage implies that the equipment shall not generate overvoltage in excess of this value when used in accordance with the relevant standard and instructions of the manufacturer.

NOTE 1 The residual risk that voltages in excess of the rated impulse voltage can be generated depends on the circuit conditions.

If a switching device with a particular rated impulse voltage or overvoltage category does not generate overvoltages higher than those of a lower overvoltage category, it has two rated impulse voltages or two overvoltage categories: the higher one referring to its impulse withstand voltage, the lower one referring to the generated overvoltage.

NOTE 2 A given value of rated impulse voltage implies that overvoltages up to that magnitude may become effective in the system and that, as a consequence, the equipment may be unsuitable for use in lower overvoltage categories or require suppression means suitable for the lower category.

4.3.3.6 Interface requirements

Equipment may be used under the conditions of a higher overvoltage category where appropriate overvoltage reduction is provided. Appropriate overvoltage attenuation can be achieved by

- an overvoltage protective device,
- a transformer with isolated windings,
- a distribution system with a multiplicity of branch circuits (capable of diverting energy of surges),
- a capacitance capable of absorbing energy of surges,
- a resistance or similar damping device capable of dissipating the energy of surges.

NOTE Attention is drawn to the fact that any overvoltage protective device within the installation or within equipment may have to dissipate more energy than any overvoltage protective device at the origin of the installation having a higher clamping voltage. This applies particularly to the overvoltage protective device with the lowest clamping voltage.

4.3.4 Determination of recurring peak voltage

The waveshape of the voltage is measured by an oscilloscope of sufficient bandwidth, from which the peak amplitude is determined according to Figure 1.

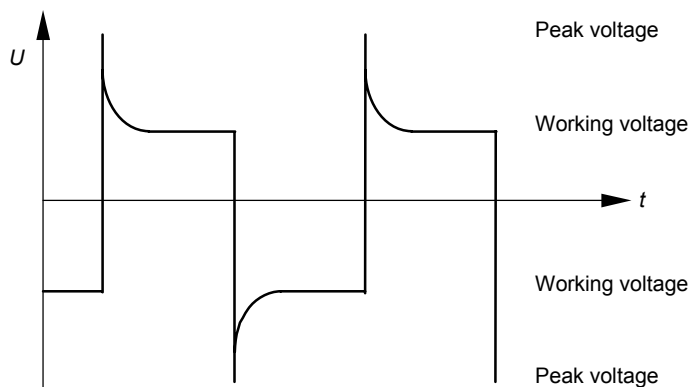

IEC 1206/02

Figure 1 – Recurring peak voltage

4.3.5 Determination of temporary overvoltage

4.3.5.1 General

Situations related to the most onerous temporary overvoltages due to faults in the supply system are considered in IEC 60364-4-44.

NOTE IEC 60364-4-44 deals with the safety of persons and equipment in a low-voltage system in the event of a fault between the high-voltage system and earth of transformers that supply low-voltage systems.

4.3.5.2 Fault voltage

The magnitude and the duration of the fault voltage or the touch voltage due to an earth fault in the high-voltage system are shown in Figure 44A of IEC 60364-4-44.

4.3.5.3 Stress due to temporary overvoltages

The magnitude and duration of a temporary overvoltage in low-voltage equipment due to an earth fault in the high-voltage system are given in 5.3.3.2.3.

4.4 Frequency

This standard applies for frequencies up to 30 kHz.

NOTE Dimensioning for frequencies above 30 kHz is specified in IEC 60664-4.

4.5 Time under voltage stress

With regard to creepage distances, the time under voltage stress influences the number of occasions when drying out can result in surface scintillations with energy high enough to entail tracking. The number of such occasions is considered to be sufficiently large to cause tracking

- in equipment intended for continuous use but not generating sufficient heat to keep the surface of the insulation dry,
- in equipment subjected to condensation for extended periods during which it is frequently switched on and off,
- on the input side of a switching device, and between its line and load terminals, that is connected directly to the supply mains.

The creepage distances shown in Table F.4 have been determined for insulation intended to be under voltage stress during a long period of time.

NOTE Technical committees responsible for equipment in which insulation is under voltage stress for only a short time may consider allowing reduced creepage distances for functional insulation, for example of one voltage step lower than specified in Table F.4.

4.6 Pollution

4.6.1 General

The micro-environment determines the effect of pollution on the insulation. The macro-environment, however, has to be taken into account when considering the micro-environment.

Means may be provided to reduce pollution at the insulation under consideration by effective use of enclosures, encapsulation or hermetic sealing. Such means to reduce pollution may not be effective when the equipment is subject to condensation or if, in normal operation, it generates pollutants itself.

Small clearances can be bridged completely by solid particles, dust and water and therefore minimum clearances are specified where pollution may be present in the micro-environment.

NOTE 1 Pollution will become conductive in the presence of humidity. Pollution caused by contaminated water, soot, metal or carbon dust is inherently conductive.

NOTE 2 Conductive pollution by ionized gases and metallic depositions occurs only in specific instances, for example in arc chambers of switchgear or controlgear, and is not covered by this part of IEC 60664.

4.6.2 Degrees of pollution in the micro-environment

For the purpose of evaluating creepage distances and clearances, the following four degrees of pollution in the micro-environment are established:

- *Pollution degree 1*
No pollution or only dry, non-conductive pollution occurs. The pollution has no influence.
- *Pollution degree 2*
Only non-conductive pollution occurs except that occasionally a temporary conductivity caused by condensation is to be expected.
- *Pollution degree 3*
Conductive pollution occurs or dry non-conductive pollution occurs which becomes conductive due to condensation which is to be expected.
- *Pollution degree 4*
Continuous conductivity occurs due to conductive dust, rain or other wet conditions.

4.6.3 Conditions of conductive pollution

The dimensions for creepage distance cannot be specified where permanently conductive pollution is present (pollution degree 4). For temporarily conductive pollution (pollution degree 3), the surface of the insulation may be designed to avoid a continuous path of conductive pollution, e.g. by means of ribs and grooves (see 5.2.2.5 and 5.2.5).

4.7 Information supplied with the equipment

Technical committees shall specify the relevant information to be supplied with the equipment and the way this is to be provided.

4.8 Insulating material

4.8.1 Comparative tracking index (CTI)

4.8.1.1 Behaviour of insulating material in the presence of scintillations

With regard to tracking, an insulating material can be roughly characterized according to the damage it suffers from the concentrated release of energy during scintillations when a surface leakage current is interrupted due to the drying-out of the contaminated surface. The following behaviour of an insulating material in the presence of scintillations can occur:

- no decomposition of the insulating material;
- the wearing away of insulating material by the action of electrical discharges (electrical erosion);
- the progressive formation of conductive paths which are produced on the surface of insulating material due to the combined effects of electric stress and electrolytically conductive contamination on the surface (tracking).

NOTE Tracking or erosion will occur when

- a liquid film carrying the surface leakage current breaks, and
- the applied voltage is sufficient to break down the small gap formed when the film breaks, and
- the current is above a limiting value which is necessary to provide sufficient energy locally to thermally decompose the insulating material beneath the film.

Deterioration increases with the time for which the current flows.

4.8.1.2 CTI values to categorize insulating materials

A method of classification for insulating materials according to 4.8.1.1 does not exist. The behaviour of the insulating material under various contaminants and voltages is extremely complex. Under these conditions, many materials may exhibit two or even all three of the characteristics stated. A direct correlation with the material groups of 4.8.1.3 is not practical. However, it has been found by experience and tests that insulating materials having a higher relative performance also have approximately the same relative ranking according to the comparative tracking index (CTI). Therefore, this standard uses the CTI values to categorize insulating materials.

4.8.1.3 Material groups

For the purposes of this standard, materials are classified into four groups according to their CTI values. These values are determined in accordance with IEC 60112 using solution A. The groups are as follows:

- material group I: $600 \leq \text{CTI}$;
- material group II: $400 \leq \text{CTI} < 600$;
- material group IIIa: $175 \leq \text{CTI} < 400$;
- material group IIIb: $100 \leq \text{CTI} < 175$.

The proof tracking index (PTI) is used to verify the tracking characteristics of materials. A material may be included in one of these four groups on the basis that the PTI, verified by the method of IEC 60112 using solution A, is not less than the lower value specified for the group.

4.8.1.4 Test for comparative tracking index (CTI)

The test for comparative tracking index (CTI) in accordance with IEC 60112 is designed to compare the performance of various insulating materials under test conditions. It gives a qualitative comparison and in the case of insulating materials having a tendency to form tracks, it also gives a quantitative comparison.

4.8.1.5 Non tracking materials

For glass, ceramics or other inorganic insulating materials which do not track, creepage distances need not be greater than their associated clearance for the purpose of insulation coordination. The dimensions of Table F.2 for inhomogeneous field conditions are appropriate.

4.8.2 Electric strength characteristics

The electric strength characteristics of insulating material shall be considered by the technical committees, taking into account the stresses described in 5.3.1, 5.3.2.2.1 and 5.3.2.3.1.

4.8.3 Thermal characteristics

The thermal characteristics of insulating material shall be considered by the technical committees taking into account the stresses described in 5.3.2.2.2, 5.3.2.3.2 and 5.3.3.5.

NOTE See also IEC 60216.

4.8.4 Mechanical and chemical characteristics

The mechanical and chemical characteristics of insulating material shall be considered by the technical committees, taking into account the stresses described in 5.3.2.2.3, 5.3.2.3.3 and 5.3.2.4.

5 Requirements and dimensioning rules

5.1 Dimensioning of clearances

5.1.1 General

Clearances shall be dimensioned to withstand the required impulse withstand voltage. For equipment directly connected to the low-voltage mains the required impulse withstand voltage is the rated impulse voltage established on the basis of 4.3.3.3. If a steady-state r.m.s. voltage, a temporary overvoltage or a recurring peak voltage requires larger clearances than required for the impulse withstand voltage, the corresponding values of Table F.7a shall be used. The largest clearance shall be selected resulting from consideration of impulse withstand voltage, steady-state r.m.s. voltage, temporary overvoltage and recurring peak voltage.

NOTE Dimensioning for steady-state r.m.s. or recurring peak voltage leads to a situation in which there is no margin with respect to breakdown with the continuous application of these voltages. Technical committees should take this into account.

5.1.2 Dimensioning criteria

5.1.2.1 General

Clearance dimensions shall be selected, taking into account the following influencing factors:

- impulse withstand voltage according to 5.1.5 for functional insulation and 5.1.6 for basic, supplementary and reinforced insulation;
- steady-state withstand voltages and temporary overvoltages (see 5.1.2.3);
- recurring peak voltages (see 5.1.2.3);
- electric field conditions (see 5.1.3);
- altitude: the clearance dimensions specified in Table F.2 and Table F.7a give withstand capability for equipment for use in altitudes up to 2 000 m. For equipment for use at higher altitudes 5.1.4 applies;
- degrees of pollution in the micro-environment (see 4.6.2).

Larger clearances may be required due to mechanical influences such as vibration or applied forces.

5.1.2.2 Dimensioning to withstand transient overvoltages

Clearances shall be dimensioned to withstand the required impulse withstand voltage, according to Table F.2. For equipment directly connected to the supply mains, the required impulse withstand voltage is the rated impulse voltage established on the basis of 4.3.3.3.

NOTE IEC 60664-5 provides an alternative and more precise dimensioning procedure for clearances equal to or less than 2 mm.

5.1.2.3 Dimensioning to withstand steady-state voltages, temporary overvoltages or recurring peak voltages

Clearances shall be dimensioned according to Table F.7a to withstand the peak value of the steady-state voltage (d.c. or 50/60 Hz), the temporary overvoltage or the recurring peak voltage.

The dimensioning according to Table F.7 shall be compared with Table F.2, taking into account the pollution degree. The larger clearance shall be selected.

NOTE Dimensioning requirements for frequencies higher than 30 kHz are specified in IEC 60664-4.

5.1.3 Electric field conditions

5.1.3.1 General

The shape and arrangement of the conductive parts (electrodes) influence the homogeneity of the field and consequently the clearance needed to withstand a given voltage (see Table F.2, Table F.7a and Table A.1).

5.1.3.2 Inhomogeneous field conditions (case A of Table F.2)

Clearances not less than those specified in Table F.2 for inhomogeneous field conditions can be used irrespective of the shape and arrangement of the conductive parts and without verification by a voltage withstand test.

Clearances through openings in enclosures of insulating material shall not be less than those specified for inhomogeneous field conditions since the configuration is not controlled, which may have an adverse effect on the homogeneity of the electric field.

5.1.3.3 Homogeneous field conditions (case B of Table F.2)

Values for clearances in Table F.2 for case B are only applicable for homogeneous fields. They can only be used where the shape and arrangement of the conductive parts is designed to achieve an electric field having an essentially constant voltage gradient.

Clearances smaller than those for inhomogeneous field conditions require verification by a voltage withstand test (see 6.1.2).

NOTE For small values of clearances, the uniformity of the electric field can deteriorate in the presence of pollution, making it necessary to increase the clearances above the values of case B.

5.1.4 Altitude

As the dimensions in Table F.2 and Table F.7 are valid for altitudes up to 2 000 m above sea level, the altitude correction factors specified in Table A.2 are applicable for clearances for altitudes above 2 000 m.

NOTE The breakdown voltage of a clearance in air for a homogeneous field (withstand voltage case B in Table A.1) is, according to Paschen's Law, proportional to the product of the distance between electrodes and the atmospheric pressure. Therefore experimental data recorded at approximately sea level is corrected according to the difference in atmospheric pressure between 2 000 m and sea level. The same correction is made for inhomogeneous fields.

5.1.5 Dimensioning of clearances of functional insulation

For a clearance of functional insulation, the required withstand voltage is the maximum impulse voltage or steady-state voltage (with reference to Table F.7) or recurring peak voltage (with reference to Table F.7) expected to occur across it, under rated conditions of the equipment, and in particular the rated voltage and rated impulse voltage (refer to Table F.2).

5.1.6 Dimensioning of clearances of basic, supplementary and reinforced insulation

Clearances of basic and supplementary insulation shall each be dimensioned as specified in Table F.2 corresponding to

- the rated impulse voltage, according to 4.3.3.3 or 4.3.3.4.1, or
- the impulse withstand voltage requirements according to 4.3.3.4.2;

and as specified in Table F.7a corresponding to

- the steady-state voltage according to 4.3.2.2,
- the recurring peak voltage according to 4.3.4,

- and the temporary overvoltage according to 4.3.5.

With respect to impulse voltages, clearances of reinforced insulation shall be dimensioned as specified in Table F.2 corresponding to the rated impulse voltage but one step higher in the preferred series of values in 4.2.3 than that specified for basic insulation. If the impulse withstand voltage required for basic insulation according to 4.3.3.4.2, is other than a value taken from the preferred series, reinforced insulation shall be dimensioned to withstand 160 % of the impulse withstand voltage required for basic insulation.

NOTE 1 In a coordinated system, clearances above the minimum required are unnecessary for a required impulse withstand voltage. However, it may be necessary, for reasons other than insulation coordination, to increase clearances (for example due to mechanical influences). In such instances, the test voltage is to remain based on the rated impulse voltage of the equipment, otherwise undue stress of associated solid insulation may occur.

With respect to steady-state voltages, including peak voltages and temporary overvoltages clearances of reinforced insulation shall be dimensioned as specified in Table F.7a to withstand 160 % of the withstand voltage required for basic insulation.

For equipment provided with double insulation where basic insulation and supplementary insulation cannot be tested separately, the insulation system is considered as reinforced insulation.

NOTE 2 When dimensioning clearances to accessible surfaces of insulating material, such surfaces are assumed to be covered by metal foil. Further details can be specified by technical committees.

5.1.7 Isolating distances

See 8.3.2 of IEC 61140.

5.2 Dimensioning of creepage distances

5.2.1 General

The values of Table F.4 are suitable for the majority of applications. If more precise dimensioning of creepage distances not greater than 2 mm is needed, IEC 60664-5 is relevant.

5.2.2 Influencing factors

5.2.2.1 General

Creepage distances shall be selected from Table F.4. The following influencing factors are taken into account:

- voltage according to 4.3.2 (see also 5.2.2.2);
- micro-environment (see 5.2.2.3);
- orientation and location of creepage distance (see 5.2.2.4);
- shape of insulating surface (see 4.6.3 and 5.2.2.5);
- insulating materials (see 4.8.1);
- time under voltage stress (see 4.5).

NOTE The values of Table F.4 are based upon existing empirical data and are suitable for the majority of applications. However, for functional insulation, values of creepage distances other than those of Table F.4 may be appropriate.

5.2.2.2 Voltage

The basis for the determination of a creepage distance is the long-term r.m.s. value of the voltage existing across it. This voltage is the working voltage (see 5.2.3), the rated insulation voltage (see 5.2.4) or the rated voltage (see 5.2.4).

Transient overvoltages are neglected since they will normally not influence the tracking phenomenon. However, temporary and functional overvoltages have to be taken into account if their duration and frequency of occurrence can influence tracking.

5.2.2.3 Pollution

The influence of the degrees of pollution in the micro-environment, specified in 4.6.2, on the dimensioning of creepage distances is taken into account in Table F.4.

NOTE In an equipment, different micro-environmental conditions can exist.

5.2.2.4 Orientation and location of a creepage distance

If necessary, the manufacturer shall indicate the intended orientation of the equipment or component in order that creepage distances be not adversely affected by the accumulation of pollution for which they were not designed.

NOTE Long-term storage has to be taken into account.

5.2.2.5 Shape of insulating surface

Shaping of insulating surfaces is effective for dimensioning of creepage distances under pollution degree 3 only. Preferably, the surface of solid insulation should include transverse ribs and grooves that break the continuity of the leakage path caused by pollution. Likewise, ribs and grooves may be used to divert any water away from insulation which is electrically stressed. Joints or grooves joining conductive parts should be avoided since they can collect pollution or retain water.

NOTE Long-term storage should be taken into account. The evaluation of the length of a creepage path is given in 6.2.

5.2.2.6 Relationship to clearance

A creepage distance cannot be less than the associated clearance so that the shortest creepage distance possible is equal to the required clearance. However, there is no physical relationship, other than this dimensional limitation, between the minimum clearance in air and the minimum acceptable creepage distance.

Creepage distances less than the clearances required in case A of Table F.2 may only be used under conditions of pollution degrees 1 and 2 when the creepage distance can withstand the voltage required for the associated clearance (Table F.2). The test to demonstrate that the creepage distance will withstand the voltage for the associated clearance shall take into account the altitude correction factor (see 6.1.2.2).

Comparison of the minimum clearances and creepage distances specified in this standard is described in Annex E.

5.2.2.7 Creepage distances where more than one material is used or more than one pollution degree occurs

A creepage distance may be split in several portions of different materials and/or have different pollution degrees if one of the creepage distances is dimensioned to withstand the total voltage or if the total distance is dimensioned according to the material having the lowest CTI and the highest pollution degree.

5.2.2.8 Creepage distances split by floating conductive part

A creepage distance may be split into several parts, made with the same insulation material, including or separated by floating conductors as long as the sum of the distances across each

individual part is equal or greater than the creepage distance required if the floating part did not exist.

The minimum distance X for each individual part of the creepage distance is given in 6.2 (see also Example 11).

5.2.3 Dimensioning of creepage distances of functional insulation

Creepage distances of functional insulation shall be dimensioned as specified in Table F.4 corresponding to the working voltage across the creepage distance considered.

When the working voltage is used for dimensioning, it is allowed to interpolate values for intermediate voltages. When interpolating, linear interpolation shall be used and values shall be rounded to the same number of digits as the values picked up from the tables.

5.2.4 Dimensioning of creepage distances of basic, supplementary and reinforced insulation

Creepage distances of basic and supplementary insulation shall be selected from Table F.4 for:

- the rationalized voltages (see 4.3.2.2) given in columns 2 and 3 of Table F.3a and columns 2, 3 and 4 of Table F.3b, corresponding to the nominal voltage of the supply low-voltage mains;
- the rated insulation voltage according to 4.3.2.2.1;
- the voltage specified in 4.3.2.2.2.

NOTE 1 For supplementary insulation, the pollution degree, insulating material, mechanical stresses and environmental conditions of use may be different from those for basic insulation.

When the voltage specified in 4.3.2.2.2 is used for dimensioning, it is allowed to interpolate values for intermediate voltages. When interpolating, linear interpolation shall be used. In case of interpolation values shall be rounded to the same number of digits as the values picked up from the tables.

Creepage distances of double insulation are the sum of the values of the basic and supplementary insulation which make up the double insulation system.

Creepage distances for reinforced insulation shall be twice the creepage distance for basic insulation from Table F.4.

NOTE 2 When dimensioning creepage distances to accessible surfaces of insulating material, such surfaces are assumed to be covered by metal foil. Further details can be specified by technical committees.

5.2.5 Reduction of creepage distances with the use of a rib (ribs)

Required creepage distances equal to or larger than 8 mm under pollution degree 3, may be reduced by the use of a rib. The values of these reduced creepage distances are those values listed in Table F.4 in brackets (see Note 4 of Table F.4). The rib shall have a minimum width (W) of 20 % and a minimum height (H) of 25 % of the required creepage distance including the rib as measured in Figure 2.

Where more than one rib is used, the required creepage distance shall be divided into sections equal to the number of wanted ribs. For each section the requirements of the above paragraph shall apply. The minimum distance between the multiple ribs shall be equal to the minimum width of the rib applicable for each section, measured from the base of the rib.

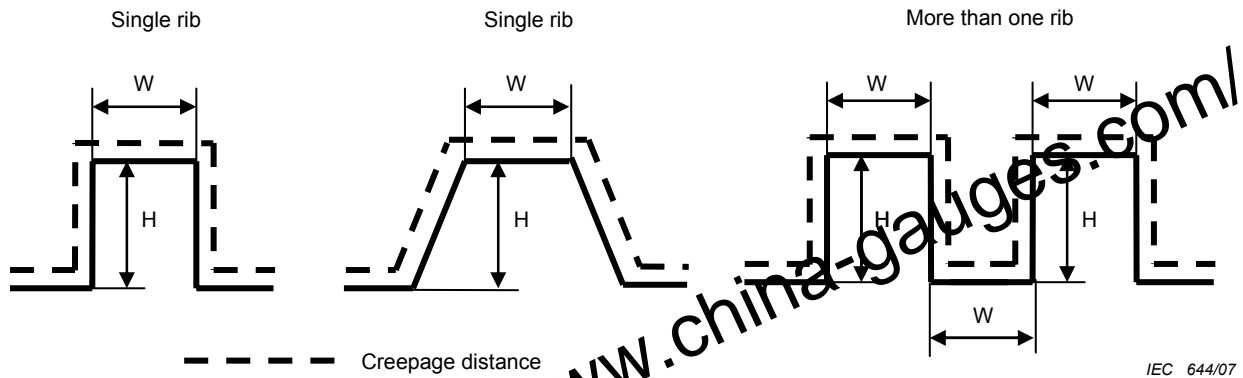

Figure 2 – Determination of the width (W) and height (H) of a rib

5.3 Requirements for design of solid insulation

5.3.1 General

As the electric strength of solid insulation is considerably greater than that of air, it may receive little attention during the design of low-voltage insulation systems. On the other hand, the insulating distances through solid insulating material are, as a rule, much smaller than the clearances so that high electric stresses result. Another point to be considered is that the high electric strength of material is seldom made use of in practice. In insulation systems gaps may occur between electrodes and insulation and between different layers of insulation, or voids may be present in the insulation. Partial discharges can occur in these gaps or voids at voltages far below the level of puncture and this may influence decisively the service life of the solid insulation. However, partial discharges are unlikely to occur below a peak voltage of 500 V.

Of equally fundamental importance is the fact that solid insulation, as compared with gases, is not a renewable insulating medium so that, for example, high voltage peaks which may occur infrequently can have a very damaging effect on solid insulation. This situation can occur while in service and during routine high-voltage testing.

A number of detrimental influences accumulate over the service life of solid insulation. These follow complex patterns and result in ageing. Therefore, electrical and other stresses (e.g. thermal, environmental) are superimposed and contribute to ageing.

The long-term performance of solid insulation can be simulated by a short-term test in combination with suitable conditioning (see 6.1.3.2).

If solid insulation is subjected to high frequencies, the dielectric losses of solid insulation and partial discharges become increasingly important. This condition has been observed in switched-mode power supplies where the insulation is subjected to repetitive voltage peaks at frequencies up to 500 kHz.

There is a general relationship between the thickness of solid insulation and the aforesaid failure mechanisms. By a reduction of the thickness of solid insulation the field strength is increased and leads to a higher risk of failure. As it is not possible to calculate the required thickness of solid insulation the performance can only be verified by testing.

5.3.2 Stresses

5.3.2.1 General

The stresses applied to solid insulation are divided into

- short-term, and
- long-term.

Other stresses, see 5.3.2.4, than those listed in 5.3.2.2 and 5.3.2.3 below may be applied to solid insulation in use.

5.3.2.2 Short-term stresses and their effects

5.3.2.2.1 Frequency of the voltage

The electric strength is greatly influenced by the frequency of the applied voltage. Dielectric heating and the probability of thermal instability increase approximately in proportion to the frequency. The breakdown field strength of insulation having a thickness of 3 mm when measured at power frequency according to IEC 60243-1 is between 10 kV/mm and 40 kV/mm. Increasing the frequency will reduce the electric strength of most insulating materials.

NOTE The influence of frequencies greater than 30 kHz on the electric strength is described in IEC 60664-4.

5.3.2.2.2 Heating

Heating can cause

- mechanical distortion due to the release of locked-in stress,
- softening of thermoplastics at comparatively low temperature-rise above ambient, for example temperatures above 60 °C,
- embrittlement of some materials due to loss of plasticiser,
- softening of some cross-linked materials particularly if the glass transition temperature of the material is exceeded,
- increased dielectric losses leading to thermal instability and failure.

High temperature gradients, for example during short-circuits, may cause mechanical failure.

5.3.2.2.3 Mechanical shock

In the case of inadequate impact strength, mechanical shock may cause insulation failure. Failure from mechanical shock could also occur due to reduced impact strength of materials:

- due to material becoming brittle when the temperature falls below its glass transition temperature;
- after prolonged exposure to high temperature that has caused loss of plasticiser or degradation of the base polymer.

Technical committees shall consider this when specifying environmental conditions for transportation, storage, installation and use.

5.3.2.3 Long-term stresses and their effects

5.3.2.3.1 Partial discharges (PD)

In air, partial discharges (PD) can occur at peak voltages in excess of 300 V (the Paschen minimum). Failure is by gradual erosion or treeing leading to puncture or surface flashover.

Insulation systems have different properties: some can tolerate discharges throughout their anticipated life (e.g. ceramic insulators), while others have to be discharge-free (e.g. capacitors). Voltage, repetition rate of discharges and discharge magnitude are important parameters.

The PD behaviour is influenced by the frequency of the applied voltage. It is established from accelerated life tests at increased frequency that the time to failure is approximately inversely

proportional to the frequency of the applied voltage. However, practical experience only covers frequencies up to 5 kHz since, at higher frequencies, other failure mechanisms may also be present, for example dielectric heating.

NOTE The influence of frequencies greater than 30 kHz on the PD behaviour is described in IEC 60664-4.

5.3.2.3.2 Heating

Heating causes degradation of the insulation, for example, by volatilization, oxidation or other long-term chemical changes. However, failure is often due to mechanical reasons, for example embrittlement, leading to cracking and electric breakdown. This process is continuous and cannot be simulated by short-time testing since several thousand hours testing time would be required (see IEC 60216).

5.3.2.3.3 Mechanical stresses

Mechanical stresses caused by vibration or shock during operation, storage or transportation may cause delamination, cracking or breaking-up of the insulating material.

NOTE Technical committees should consider these stresses when specifying conditions for testing.

5.3.2.3.4 Humidity

The presence of water vapour can influence the insulation resistance and the discharge extinction voltage, aggravate the effect of surface contamination, produce corrosion and dimensional changes. For some materials, high humidity will significantly reduce the electric strength. Low humidity can be unfavourable in some circumstances, for example by increasing the retention of electrostatic charge and by decreasing the mechanical strength of some materials, such as polyamide.

5.3.2.4 Other stresses

Many other stresses can damage insulation and will have to be taken into account by technical committees.

Examples of such stresses include

- radiation, both ultraviolet and ionizing,
- stress-crazing or stress-cracking caused by exposure to solvents or active chemicals,
- the effect of migration of plasticizers,
- the effect of bacteria, moulds or fungi,
- mechanical creep.

The effect of these stresses is of less importance or they will apply less often but require consideration in particular cases.

5.3.3 Requirements

5.3.3.1 General

Solid insulation of basic, supplementary and reinforced insulation shall be capable of durably withstanding electrical and mechanical stresses as well as thermal and environmental influences which may occur during the anticipated life of the equipment.

NOTE When considering electrical stresses to accessible surfaces of solid insulation, such surfaces are assumed to be covered by metal foil. Further details can be specified by technical committees.

In those instances where working voltages are non-sinusoidal with periodically recurring peaks, special consideration shall be given to possible occurrence of partial discharges.

Similarly, where insulation layers may exist and where voids in moulded insulation may exist, consideration shall be given to possible occurrence of partial discharges with resultant degradation of solid insulation.

5.3.3.2 Withstand of voltage stresses

5.3.3.2.1 General

Technical committees shall specify which voltage ratings are to be assigned to their equipment.

5.3.3.2.2 Transient overvoltages

Basic and supplementary insulation shall have

- an impulse withstand voltage requirement corresponding to the nominal of the mains voltage (see 4.3.3.3), and the relevant overvoltage category according to Table F.1; or
- an impulse withstand voltage of an internal circuit of an equipment which has been specified according to the transient overvoltages to be expected in the circuit (see 4.3.3.4).

Reinforced insulation shall have an impulse withstand voltage corresponding to the rated impulse voltage but one step higher in the preferred series of values in 4.2.3 than that specified for basic insulation. If, according to 4.3.3.4.2, the impulse withstand voltage required for basic insulation is other than a value taken from the preferred series, reinforced insulation shall be dimensioned to withstand 160 % of the value required for basic insulation.

For verification by testing, see 6.1.3.3.

5.3.3.2.3 Temporary overvoltages

Basic and supplementary solid insulation shall withstand the following temporary overvoltages:

- short-term temporary overvoltages of $U_n + 1\,200$ V with durations up to 5 s;
- long-term temporary overvoltages of $U_n + 250$ V with durations longer than 5 s;

where U_n is the nominal line-to-neutral voltage of the neutral-earthed supply system.

Reinforced insulation shall withstand twice the temporary overvoltages specified for basic insulation.

For verification by testing see 6.1.3.

NOTE 1 These values are from Clause 442 of IEC 60364-4-44, where U_n is called U_o .

NOTE 2 The values are r.m.s. values.

5.3.3.2.4 Recurring peak voltages

The maximum recurring peak voltages occurring on the low-voltage mains can be assumed provisionally to be $F_4 \times \sqrt{2} U_n$, i.e. 1,1 times the peak value at U_n . Where recurring peak voltages are present, the discharge extinction voltage shall be at least:

- $F_1 \times F_4 \times \sqrt{2} U_n$, i.e. $1,32 \sqrt{2} U_n$ for each basic and supplementary insulation, and
- $F_1 \times F_3 \times F_4 \times \sqrt{2} U_n$, i.e. $1,65 \sqrt{2} U_n$ for reinforced insulation.

NOTE $\sqrt{2} U_n$ is in neutral-earthed systems the peak value of the line-to neutral fundamental (undistorted) voltage at nominal voltage of mains. The application of the multiplying factors used in this subclause is described in

Annex D.

For an explanation of factors F , see 6.1.3.5.

In internal circuits, the highest recurring peak voltages have to be evaluated in place of $F \times \sqrt{2} U_n$ and solid insulation shall meet the requirements correspondingly.

For verification by testing see 6.1.3.5.

5.3.3.2.5 High-frequency voltage

For voltages with frequencies above power frequency, the influence of frequency according to 5.3.2.2.1 and 5.3.2.3.1 shall be taken into account. Frequencies above 1 kHz shall be considered as high frequencies within the scope of this standard.

Technical committees shall specify whether a test according to 6.1.3.7 is necessary.

5.3.3.3 Withstand of short-term heating stresses

Solid insulation shall not be impaired by short-term heating stresses which may occur in normal and, where appropriate, abnormal use. Technical committees shall specify severity levels.

NOTE Standard severity levels are specified in IEC 60068.

5.3.3.4 Withstand of mechanical stresses

Solid insulation shall not be impaired by mechanical vibration or shock which can be expected in use. Technical committees shall specify severity levels.

NOTE Standard severity levels are specified in IEC 60068.

5.3.3.5 Withstand of long-term heating stresses

Thermal degradation of solid insulation shall not impair insulation coordination during the anticipated life of the equipment. Technical committees shall specify whether a test is necessary. (See also IEC 60085 and IEC 60216.)

5.3.3.6 Withstand of the effects of humidity

Insulation coordination shall be maintained under the humidity conditions as specified for the equipment. (See also 6.1.3.2.)

5.3.3.7 Withstand of other stresses

Equipment may be subjected to other stresses, for example as indicated in 5.3.2.4, which may adversely affect solid insulation. Technical committees shall state such stresses and specify test methods.

6 Tests and measurements

6.1 Tests

6.1.1 General

The following test procedures apply to type testing, so that a possible deterioration of the test specimen may be tolerated. It is assumed that further use of the test specimen is not intended.

NOTE 1 If further use of the test specimen is intended or required, particular consideration is necessary by the technical committee. In such cases any high-voltage test should be combined with a partial discharge measurement according to 6.1.3.5 and Annex C.

Test procedures are specified for

- the verification of clearances (see 6.1.2),
- the verification of solid insulation (see 6.1.3),
- dielectric tests on complete equipment (see 6.1.4) and
- other tests (see 6.1.5).

The stresses for clearances and solid insulation caused by transient overvoltages are assessed by the impulse voltage test, which may be substituted by an a.c. voltage test or a d.c. voltage test. Clearances equal to or larger than case A of Table F.2 may be verified by measurement or by a voltage test. If they are smaller than the values according to the values of case A of Table F.2, they have to be verified by a voltage test.

The ability of solid insulation to withstand the voltage stresses has to be verified by a voltage test in any case. The stresses caused by transient overvoltages are assessed by the impulse voltage test, which may be substituted by an a.c. voltage test or a d.c. voltage test. The stresses caused by an a.c. steady-state voltage stress can only be assessed by an a.c. voltage test. The d.c. voltage test with a test voltage equal to the peak value of the a.c. voltage is not fully equivalent to the a.c. voltage test due to the different withstand characteristics of solid insulation for these types of voltages. However in case of a pure d.c. voltage stress, the d.c. voltage test is appropriate.

NOTE 2 While it is possible to substitute an impulse voltage test for clearances by an a.c. voltage test or by a d.c. voltage test, it is in principle not possible to substitute an a.c. voltage test for solid insulation by an impulse voltage test. The main reasons for this are the different propagation of the impulse voltages compared to power frequency voltages, especially in complex circuits, and the dependency of the withstand characteristics of solid insulation on the shape and the duration of the voltage stress.

6.1.2 Test for verification of clearances

6.1.2.1 General

When electrical equipment is subjected to electric tests for verifying clearances, the test shall be in accordance with withstand voltage requirements specified in 5.1. The appropriate test for the verification of clearances is the impulse voltage test, but as stated in 5.1.3, the test is only required for clearances smaller than case A values of Table F.2.

If the withstand against steady state voltages, recurring peak voltages or temporary overvoltages according to 5.1 is decisive for the dimensioning of clearances and if those clearances are smaller than the case A values of Table F.7a an a.c. test voltage according to 6.1.2.2.2.2 test is required.

When verifying clearances within equipment by an impulse voltage test, it is necessary to ensure that the specified impulse voltage appears at the clearance under test.

NOTE 1 The electric testing of clearances will also stress the associated solid insulation.

NOTE 2 For some cases, these tests also have to be applied to creepage distances, see 5.2.2.6.

NOTE 3 For testing complete equipment, see 6.1.4.

6.1.2.2 Test voltages

6.1.2.2.1 Impulse voltage dielectric test

6.1.2.2.1.1 General

The purpose of this test is to verify that clearances will withstand specified transient over-voltages. The impulse withstand test is carried out with a voltage having a 1,2/50 μ s waveform with the values specified in Table F.5. For the waveform 6.1.2.2.1.3 of IEC 61180-1 apply. It is intended to simulate overvoltages of atmospheric origin and covers overvoltages due to switching of low-voltage equipment.

Due to the scatter of the test results of any impulse voltage test, the test shall be conducted for a minimum of three impulses of each polarity with an interval of at least 1 s between pulses.

NOTE 1 The output impedance of the impulse generator should not be higher than 500 Ω . When carrying out tests on equipment incorporating components across the test circuit, a much lower virtual impulse generator impedance should be specified (see 9.2 in IEC 61180-2). In such cases, possible resonance effects, which can increase the peak value of the test voltage, should be taken into account when specifying test voltage values.

Technical committees may specify alternative dielectric tests according to 6.1.2.2.2.

NOTE 2 Values given in Table F.5 are derived from the calculation in 6.1.2.2.1.3. For accuracy of information, they are given with a high level of precision. For practical application, technical committees may choose to round the values.

6.1.2.2.1.2 Selection of impulse test voltage

If an electric test for insulation coordination of equipment with respect to clearances is required (for clearances smaller than case A as specified in Table F.2), the equipment shall be tested with the impulse test voltage corresponding to the rated impulse voltage specified in accordance with 4.3.3. The impulse test voltages of Table F.5 apply.

For the test conditions, technical committees shall specify temperature and humidity values.

Technical committees shall consider whether sampling tests or routine tests have to be carried out in addition to type tests.

6.1.2.2.1.3 Explanations to Table F.5

The following gives some explanation on how to interpret the data in Table F.5:

a) Correction factors for impulse voltage testing

According to 1.1, the rated impulse voltage is valid for equipment used up to 2 000 m above sea level. At 2 000 m, the normal barometric pressure is 80 kPa, while at sea level the value is 101,3 kPa. Therefore, the equipment tested at locations lower than 2 000 m is tested using higher impulse test voltages. Table F.5 gives the impulse test voltage value for verifying clearances at different altitudes.

The basis for the calculation of the sea level values and data for determining test values for other test locations is as follows:

The altitude correction factors given in Table A.2 are considered in relation to the curve of Figure A.1. The relationship is as follows:

$$k_u = \left(\frac{1}{k_d} \right)^m$$

where

d is the clearance under consideration in millimetres;

k_u is the altitude factor for voltage correction;

k_d is the altitude factor for distance correction (see Table F.8);

m is the gradient of the relevant straight line in curve 1 in Figure A.1 (logarithmic scales on the two co-ordinate axes) and has the value.

$m = 0,9163$ for $0,001 < d \leq 0,01$ mm

$m = 0,3305$ for $0,01 < d \leq 0,0625$ mm;

$m = 0,6361$ for $0,0625 < d \leq 1$ mm;

$m = 0,8539$ for $1 < d \leq 10$ mm;

$m = 0,9243$ for $10 < d \leq 100$ mm.

Applying altitude correction factors for distance correction results in curve 1 of Figure A.1, the voltages will be changed with four different steps at only one shifting step for distance. The mathematical formula for this operation is shown above. Table F.5 includes this calculation as described.

b) *General discussion of factors influencing the electric strength of clearances*

The influencing factors are as follows:

- air pressure;
- temperature;
- humidity.

For the purpose of testing the factors of temperature, humidity and climatic variations of air pressure are not taken into account provided that normal laboratory conditions exist.

Normal laboratory conditions are specified in IEC 60068-1:

- Temperature: 15 °C to 35 °C;
- Air pressure: 86 kPa to 106 kPa at sea level;
- Relative humidity: 25 % to 75 %.

6.1.2.2.2 Alternatives to impulse voltage dielectric tests

6.1.2.2.2.1 General

Technical committees may specify an a.c. or d.c. voltage test for particular equipment as an alternative method.

NOTE While tests with a.c. and d.c. voltages of the same peak value as the impulse test voltage specified in Table F.5 verify the withstand capability of clearances, they more highly stress solid insulation because the voltage is applied for longer duration. They can overload and damage certain solid insulations. Technical committees should therefore consider this when specifying tests with a.c. or d.c. voltages as an alternative to the impulse voltage test given in 6.1.2.2.1.

6.1.2.2.2.2 Dielectric test with a.c. voltage

The waveshape of the sinusoidal power frequency test voltage shall be substantially sinusoidal. This requirement is fulfilled if the ratio between the peak value and the r.m.s. value is $\sqrt{2} \pm 3\%$. The peak value shall be equal to the impulse test voltage of Table F.5 and applied for three cycles of the a.c. test voltage.

6.1.2.2.2.3 Dielectric test with d.c. voltage

The d.c. test voltage shall be substantially free of ripple. This requirement is fulfilled if the ratio between the peak values of the voltage and the average value is $1,0 \pm 3\%$. The average value of the d.c. test voltage shall be equal to the impulse test voltage of Table F.5 and

applied three times for 10 ms in each polarity.

6.1.3 Tests for the verification of solid insulation

6.1.3.1 Selection of tests

Solid insulation that may be subjected to mechanical stresses during operation, storage, transportation or installation shall be tested with respect to vibration and mechanical shock before the dielectric testing. Technical committees may specify test methods.

NOTE Standard test methods are specified in the relevant part of IEC 60068.

The tests for insulation coordination are type tests. They have the following objectives:

- a) The impulse voltage withstand test is to verify the capability of the solid insulation to withstand the rated impulse voltage (see 5.3.3.2.2).
- b) The a.c. voltage test is to verify the capability of the solid insulation to withstand
 - the short-term temporary overvoltage (see 5.3.3.2.3);
 - the highest steady-state voltage;
 - the recurring peak voltage (see 5.3.3.2.4).

If the peak value of the a.c. test voltage is equal to or higher than the rated impulse voltage, the impulse voltage test is covered by the a.c. voltage test.

Solid insulation has a different withstand characteristic compared to clearances if the time of stress is being increased. In general the withstand capability will be decreased significantly. Therefore the a.c. voltage test, which is specified for the verification of the withstand capability of solid insulation, is not allowed to be replaced by an impulse voltage test.

- c) The partial discharge test is to verify that no partial discharges are maintained in the solid insulation:
 - at the highest steady-state voltage;
 - at the long-term temporary overvoltage (see 5.3.3.2.3);
 - at the recurring peak voltage (see 5.3.3.2.4).
- d) The high-frequency voltage test is to verify the absence of failure due to dielectric heating according to 5.3.3.2.5.

Technical committees shall specify which type tests are required for the respective stresses occurring in the equipment.

Partial discharge tests for solid insulation shall be specified if the peak value of the voltages listed under c) exceeds 700 V and if the average field strength is higher than 1 kV/mm. The average field strength is the peak voltage divided by the distance between two parts of different potential.

The above tests may also be suitable as sample or routine tests. It is, however, the responsibility of the technical committees to specify which tests shall be performed as sample and routine tests in order to ensure the quality of the insulation during production. The tests and conditioning, as appropriate, shall be specified with test parameters adequate to detect faults without causing damage to the insulation.

When performing tests on complete equipment, the procedure of 6.1.4 applies.

6.1.3.2 Conditioning

If not otherwise specified, the test shall be performed with a new test specimen. Conditioning of the specimen by temperature and humidity treatment is intended to

- represent the most onerous normal service conditions,
- expose possible weaknesses which are not present in the new condition.

Technical committees shall specify the appropriate conditioning method from the following recommended methods:

- a) dry heat (IEC 60068-2-2), in order to achieve a stable condition, which may not exist immediately after manufacture;
- b) dry heat cycle (IEC 60068-2-2), in order to induce the creation of voids which could develop in storage, transportation and normal use;
- c) thermal shock (IEC 60068-2-14), in order to induce delamination within the insulation system which may develop in storage, transportation and normal use;
- d) damp heat (IEC 60068-2-78), in order to evaluate the effect of water absorption on the electric properties of the solid insulation.

For impulse voltage, a.c. power frequency voltage and high frequency voltage tests, the most significant conditioning methods are those in a) and d). For partial discharge testing, the conditioning methods b) and c) are most relevant.

If conditioning of solid insulation is required, it shall be performed prior to type testing. The values of temperature, humidity and time shall be selected from Table F.6.

It may be appropriate to subject components, for example electrical parts, sub-assemblies, insulating parts and materials, to conditioning before electric testing. When components have already been type tested according to this subclause, such conditioning is not required.

6.1.3.3 Impulse voltage test

6.1.3.3.1 Test method

The methods for impulse voltage testing of 6.1.2.2.1 apply also to solid insulation, except that the altitude correction factors as listed in Table F.5 are not applicable. The test shall be conducted for five impulses of each polarity with an interval of at least 1 s between impulses. The waveshape of each impulse shall be recorded (see 6.1.3.3.2).

6.1.3.3.2 Acceptance criteria

No puncture or partial breakdown of solid insulation shall occur during the test, but partial discharges are allowed. Partial breakdown will be indicated by a step in the resulting waveshape which will occur earlier in successive impulses. Breakdown on the first impulse may either indicate a complete failure of the insulation system or the operation of overvoltage limiting devices in the equipment.

NOTE 1 If overvoltage limiting devices are included in the equipment, care should be taken to examine the waveshape to ensure that their operation is not taken to indicate insulation failure. Distortions of the impulse voltage which do not change from impulse to impulse may be caused by operation of such overvoltage limiting device and do not indicate a (partial) breakdown of solid insulation.

NOTE 2 Partial discharges in voids can lead to partial notches of extremely short durations which may be repeated in the course of an impulse.

6.1.3.4 A.C. power frequency voltage test

6.1.3.4.1 Test method

The waveshape of the sinusoidal power frequency test voltage shall be substantially sinusoidal. This requirement is fulfilled if the ratio between the peak value and the r.m.s. value is $\sqrt{2} \pm 3\%$. The peak value shall be equal to the highest of the voltages mentioned in 6.1.3.1 b).

For basic insulation and supplementary insulation, the test voltage has the same value as the voltages mentioned in 6.1.3.1 b). For reinforced insulation, the test voltage is twice the value used for basic insulation.

The a.c. test voltage shall be raised uniformly from 0 V to the value specified in 5.3.3.2 within not more than 5 s and held at that value for at least 60 s.

In those cases where the short term temporary overvoltage leads to the most stringent requirements with respect to the amplitude of the test voltage, a reduction of the duration of the test to a minimum value of 5 s can be considered by technical committees.

NOTE 1 For particular types of insulation, longer periods of testing can be required to detect weakness within the solid insulation.

NOTE 2 In case of testing with respect to high, steady-state stresses including high recurring peak voltage, technical committees should consider introducing a safety margin on the test voltage.

In some cases the a.c. test voltage needs to be substituted by a d.c. test voltage of a value equal to the peak value of the a.c. voltage, however this test will be less stringent than the a.c. voltage test. Technical committees shall consider this situation (see 6.1.3.6).

Test equipment is specified in IEC 61180-2. It is recommended that the short-circuit output current of the generator is not less than 200 mA.

NOTE 3 For test voltages exceeding 3 kV, it is sufficient that the rated power of the test equipment is equal to or greater than 600 VA.

The tripping current of the generator shall be adjusted to a tripping current of 100 mA or for test voltages above 6 kV to the highest possible value.

NOTE 4 For routine testing, the tripping current may be adjusted to lower levels but not less than 3,5 mA.

6.1.3.4.2 Acceptance criteria

No breakdown of solid insulation shall occur.

6.1.3.5 Partial discharge test

6.1.3.5.1 General

The waveshape of the sinusoidal power frequency test voltage shall be substantially sinusoidal. This requirement is fulfilled if the ratio between the peak value and the r.m.s. value is $\sqrt{2} \pm 3\%$. The peak value of U_t (see Figure 3) shall be equal to the highest of the voltages mentioned in 6.1.3.1 c) taking into account the multiplying factors F_1 , F_3 and F_4 as far as applicable.

Partial discharge test methods are described in Annex C. When performing the test, the following multiplying factors apply. These examples are given for the recurring peak voltage U_{rp} , the factors similarly apply to the highest steady-state voltage and to the long-term temporary overvoltage.

F_1 Basic safety factor for PD testing and dimensioning basic and supplementary insulation.

The PD extinction voltage may be influenced by environmental conditions, such as temperature. These influences are taken into account by a basic safety factor F_1 of 1,2. The PD extinction voltage for basic or supplementary insulation is therefore at least 1,2 U_{rp} .

F_2 PD hysteresis factor.

Hysteresis occurs between the PD inception voltage U_i and the PD extinction voltage U_e . Practical experience shows that F_2 is not greater than 1,25. For basic and supplementary

insulation, the initial value of the test voltage is therefore $F_1 \times F_2 \times U_{rp}$, i.e. $1,2 \times 1,25 U_{rp} = 1,5 U_{rp}$.

NOTE This takes into account that PD might be initiated by transient overvoltages exceeding U_i and could be maintained, for example, by values of the recurring peak voltage exceeding U_e . This situation would require the combination of impulse and a.c. voltages for the test, which is impractical. Therefore, an a.c. test is performed with an initially increased voltage.

F_3 Additional safety factor for PD testing and dimensioning reinforced insulation.

For reinforced insulation a more stringent risk assessment is required. Therefore, an additional safety factor $F_3 = 1,25$ is required. The initial value of the test voltage is $F_1 \times F_2 \times F_3 \times U_{rp}$, i.e. $1,2 \times 1,25 \times 1,25 U_{rp} = 1,875 U_{rp}$.

F_4 Factor covering the deviation from the nominal voltage U_n of the low-voltage mains.

For circuits connected to the low-voltage mains, this factor takes into account the maximum deviation of the mains voltage from its nominal value. Therefore, the crest voltage at nominal voltage U_n shall be multiplied by $F_4 = 1,1$.

6.1.3.5.2 Verification

The test is to verify that no partial discharges are maintained at the highest of the following values:

- the peak value of the maximum steady-state voltage;
- the peak value of the long-term temporary overvoltage (see 5.3.3.2.3);
- the recurring peak voltage (see 5.3.3.2.4).

NOTE For cases where, additionally, the actual values of PD inception and extinction voltage are of interest, the measuring procedure is described in Clause D.1.

When testing, the PD test is generally applied to components, small assemblies and small equipment. When testing complex equipment, care shall be taken to allow for excessive attenuation of PD signals when measured at the equipment terminals.

The minimum required discharge extinction voltage shall be higher, by factor F_1 , than the highest of the voltages listed above.

According to the kind of test specimen, technical committees shall specify

- the test circuit (Clause C.1),
- the measuring equipment (Clause C.3 and Clause D.2),
- the measuring frequency (C.3.1 and D.3.3),
- the test procedure (6.1.3.5.3).

6.1.3.5.3 Test procedure

The value of the test voltage U_t is 1,2 times the required partial discharge extinction voltage U_e . According to the partial discharge hysteresis (see 6.1.3.5.1) an initial value of 1,25 times the test voltage shall be applied.

The voltage shall be raised uniformly from 0 V up to the initial test voltage $F_2 \times U_t$, i.e. $F_1 \times F_2 = 1,2 \times 1,25 = 1,5$ times the highest of the voltages listed under 6.1.3.5.2. It is then kept constant for a specified time t_1 not exceeding 5 s. If no partial discharges have occurred, the test voltage is reduced to zero after t_1 . If a partial discharge has occurred, the voltage is decreased to the test voltage U_t , which is kept constant for a specified time t_2 until the partial discharge magnitude is measured.

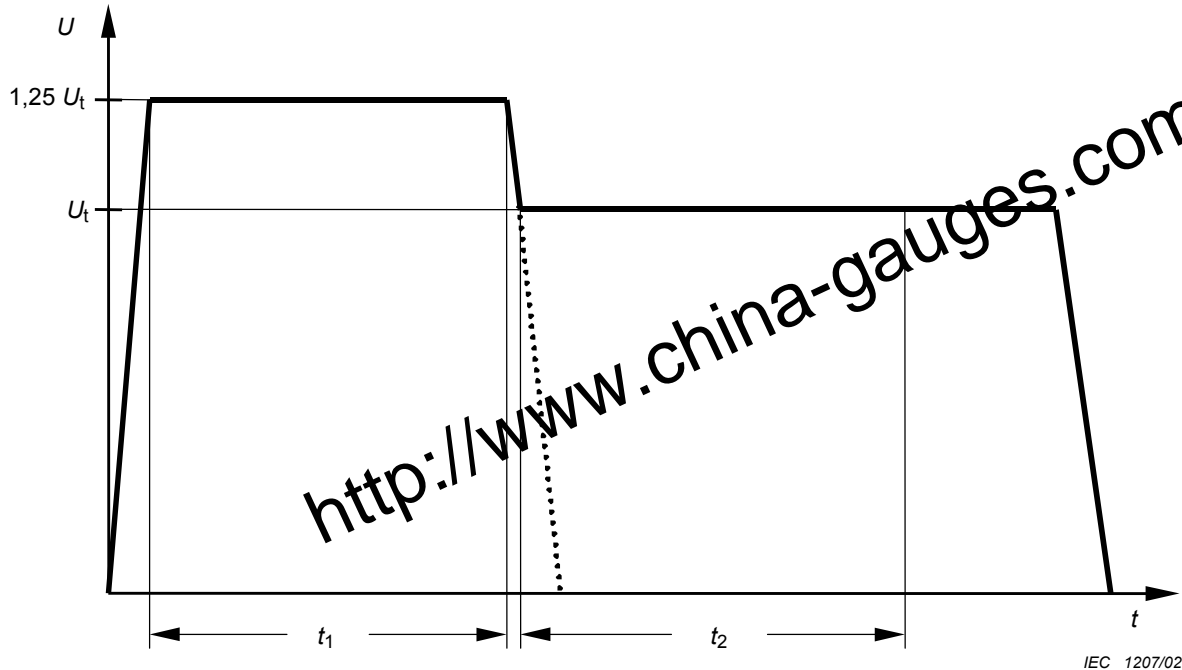

Figure 3 – Test voltages

6.1.3.5.4 Acceptance criteria

6.1.3.5.4.1 Specified discharge magnitude

As the objective is to have no continuous partial discharges under normal service conditions, the lowest practicable value shall be specified (see Clause D.3).

NOTE 1 Except for discharges caused by corona discharges in air (e.g. in non-moulded transformers), values in excess of 10 pC are not suitable.

NOTE 2 Values as small as 2 pC are possible with currently available apparatus.

The noise level shall not be subtracted from the reading of the partial discharge meter.

6.1.3.5.4.2 Test result

The solid insulation complies if

- no insulation breakdown has occurred, and
- during the application of the test voltage, partial discharges have not occurred, or after t_2 the magnitude of the discharge is not higher than specified.

6.1.3.6 DC voltage test

The d.c. voltage test with a test voltage equal to the peak value of the a.c. voltage is not fully equivalent to the a.c. voltage test due to the different withstand characteristics of solid insulation for these types of voltages. However in case of a pure d.c. voltage stress, the d.c. voltage test is appropriate.

The d.c. test voltage shall be substantially free of ripple. This requirement is fulfilled if the ratio between the peak values of the voltage and the average value is $1,0 \% \pm 3 \%$. The average value of the d.c. test voltage shall be equal to the peak value of the a.c. test voltage mentioned in 6.1.3.1 b).

For basic insulation and supplementary insulation, the test voltage has the same value as the voltages mentioned in 6.1.3.1 b). For reinforced insulation, the test voltage is twice the value

used for basic insulation.

The d.c. test voltage shall be raised uniformly from 0 V to the value specified in 5.3.3.2 within not more than 5 s and held at that value for at least 60 s.

NOTE 1 In certain cases, the charging current due to capacitances may be too high and a longer test time may be necessary.

Test equipment is specified in IEC 61180-2. It is recommended that the short-circuit output current of the generator is not less than 200 mA.

NOTE 2 For test voltages exceeding 3 kV, it is sufficient that the rated power of the test equipment is equal or greater than 600 VA.

The tripping current of the generator shall be adjusted to a tripping current of 100 mA or for test voltages above 6 kV to the highest possible value.

NOTE 3 For routine testing, the tripping current may be adjusted to lower levels but not less than 10 mA.

6.1.3.7 High-frequency voltage test

For high-frequency voltages according to 5.3.3.2.5, additional or alternative a.c. voltage tests according to 6.1.3.4 or partial discharge tests according to 6.1.3.5 may be necessary.

NOTE Information about the withstand characteristics of insulation at high frequency and methods of testing is given in IEC 60664-4.

6.1.4 Performing dielectric tests on complete equipment

6.1.4.1 General

When performing the impulse voltage test on complete equipment, the attenuation or amplification of the test voltage shall be taken into account. It needs to be assured that the required value of the test voltage is applied across the terminals of the equipment under test.

Surge protective devices (SPDs) shall be disconnected before dielectric testing.

NOTE If capacitors with high capacitance are parallel to the parts between which the test voltage needs to be applied, it may be difficult, or even impossible, to perform the a.c. voltage test because the charging current would exceed the capacity of the high voltage tester (200 mA). In the latter case, those parallel capacitors should be disconnected before testing. If this is also impossible, d.c. testing can be taken into consideration.

6.1.4.2 Parts to be tested

The test voltage shall be applied between parts of the equipment which are electrically separate from each other.

Examples of such parts include

- live parts,
- separate circuits,
- earthed circuits,
- accessible surfaces.

Non-conductive parts of accessible surfaces shall be covered with metal foil.

NOTE If a complete covering of large enclosures with metal foil is not practicable, a partial covering is sufficient if applied to those parts which provide protection against electric shock.

6.1.4.3 Preparation of equipment circuits

For the test, each circuit of the equipment shall be prepared as follows:

- external terminals of the circuit, if any, shall be connected together;
- switchgear and controlgear within equipment shall be in the closed position or bypassed;
- the terminals of voltage blocking components (such as rectifier diodes) shall be connected together;
- components such as RFI filters shall be included in the impulse test but it may be necessary to disconnect them during a.c. tests.

NOTE 1 Voltage sensitive components within any circuit of the equipment, which do not bridge basic or reinforced insulation, may be bypassed by shorting the terminals.

NOTE 2 Pre-tested plug-in printed circuit boards and pre-tested modules with multipoint connectors may be withdrawn, disconnected or replaced by dummy samples to ensure that the test voltage is propagated inside the equipment to the extent necessary for the insulation tests.

6.1.4.4 Test voltage values

Circuits connected to the low-voltage mains are tested according to 6.1.2 and 6.1.3.

The test voltage between two circuits of the equipment shall have the value corresponding to the highest voltage that actually can occur between these circuits.

6.1.4.5 Test criteria

There shall be no disruptive discharge (sparkover, flashover or puncture) during the test. Partial discharges in clearances which do not result in breakdown are disregarded, unless otherwise specified by the technical committees.

NOTE It is recommended that an oscilloscope be used to observe the impulse voltage in order to detect disruptive discharge.

6.1.5 Other tests

6.1.5.1 Test for purposes other than insulation coordination

Technical committees specifying electric tests for purposes other than verification of insulation coordination shall not specify test voltages higher than those required for insulation coordination.

6.1.5.2 Sampling and routine tests

Sampling tests and routine tests are intended to ensure production quality. It is the responsibility of the relevant technical committee, and in particular of the manufacturer, to specify these tests. They shall be carried out with the waveforms and voltage levels such that faults are detected without causing damage to the equipment (solid insulation or components).

Technical committees specifying sampling and routine tests shall in no case specify test voltages higher than those required for type testing.

6.1.6 Measurement accuracy of test parameters

All important test parameters shall be measured with high accuracy in order to provide well defined and comparable test results. For the purpose of harmonization, the accuracy of measurement of the measuring devices used for the following test parameters is given in this standard as follows:

- a) test voltage (a.c./d.c.): $\pm 3 \%$;
 test voltage (impulse): $\pm 5 \%$;
- b) current: $\pm 1,5 \%$;
- c) frequency: $\pm 0,2 \%$;
- d) temperature:
 – below $100 \text{ }^\circ\text{C}$ $\pm 2 \text{ K}$;
 – $100 \text{ }^\circ\text{C}$ up to $500 \text{ }^\circ\text{C}$ $\pm 3 \%$;
- e) relative humidity: $\pm 3 \%$ r.h.

NOTE The given accuracy refers to that of the humidity measuring device. It does not include the humidity uniformity within the chamber and/or the influence of the test sample on the humidity uniformity. The humidity in the chamber is measured only at one place before testing the sample.

- f) partial discharge magnitude: $\pm 10 \%$ or $\pm 1 \text{ pC}$ (the greater values applies);
- g) time (impulse voltage): $\pm 20 \%$;
 time (test duration): $\pm 1 \%$.

6.2 Measurement of creepage distances and clearances

The dimension X , specified in the following examples, has a minimum value depending on the pollution degree as follows:

Pollution degree	Dimension X minimum value
1	0,25 mm
2	1,0 mm
3	1,5 mm

If the associated clearance is less than 3 mm, the minimum dimension X may be reduced to one-third of this clearance.

The methods of measuring creepage distances and clearances are indicated in the following Examples 1 to 11. These cases do not differentiate between gaps and grooves or between types of insulation.

The following assumptions are made:

- any recess is assumed to be bridged with an insulating link having a length equal to the specified width X and being placed in the most unfavourable position (see Example 3);
- where the distance across a groove is equal to or larger than the specified width X , the creepage distance is measured along the contours of the groove (see Example 2);
- creepage distances and clearances measured between parts which can assume different positions in relation to each other, are measured when these parts are in their most unfavourable position.

Example 1

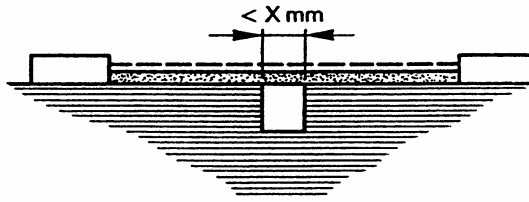

Condition: Path under consideration includes a parallel- or converging-sided groove of any depth with a width less than X mm.

Rule: Creepage distance and clearance are measured directly across the groove as shown.

Example 2

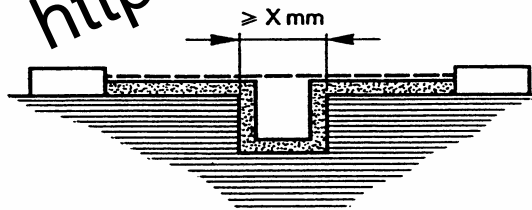

128/R1

Condition: Path under consideration includes a parallel-sided groove of any depth and equal to or more than X mm.

Rule: Clearance is the "line of sight" distance. Creepage path follows the contour of the groove.

Example 3

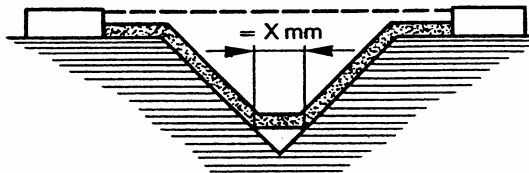

129/R1

Condition: Path under consideration includes a V-shaped groove with a width greater than X mm.

Rule: Clearance is the "line of sight" distance. Creepage path follows the contour of the groove but "short-circuits" the bottom of the groove by X mm link.



Clearance



Creepage distance

Example 4

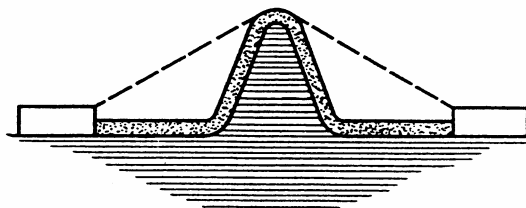

131/R1

Condition: Path under consideration includes a rib.

Rule: Clearance is the shortest direct air path over the top of the rib. Creepage path follows the contour of the rib.

Example 5

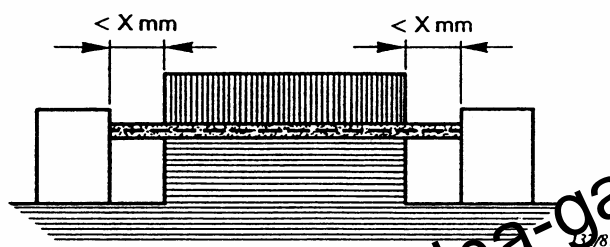

Condition: Path under consideration includes an uncemented joint with grooves less than X mm wide on each side.
 Rule: Creepage and clearance path is the "line of sight" distance shown.

Example 6

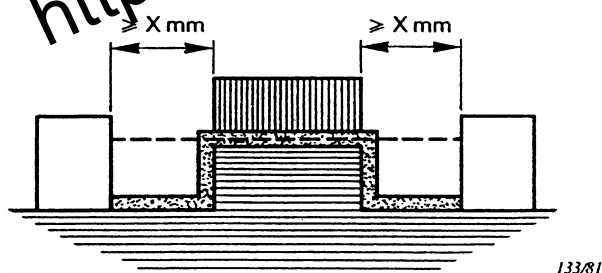

Condition: Path under consideration includes an uncemented joint with grooves equal to or more than X mm wide on each side.
 Rule: Clearance is the "line of sight" distance. Creepage path follows the contour of the grooves.

----- Clearance



Creepage distance

Example 7

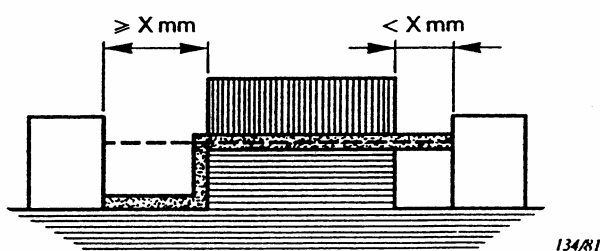

Condition: Path under consideration includes an uncemented joint with a groove on one side less than X mm wide and the groove on the other side equal to or more than X mm wide.
 Rule: Clearance and creepage paths area as shown.

Example 8

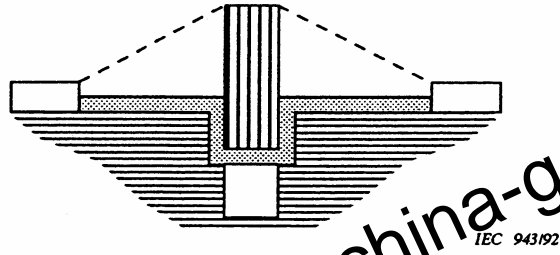

Condition: Creepage distance through uncemented joint is less than creepage distance over barrier.

Rule: Clearance is the shortest direct air path over the top of the barrier.

----- Clearance  Creepage distance

Example 9

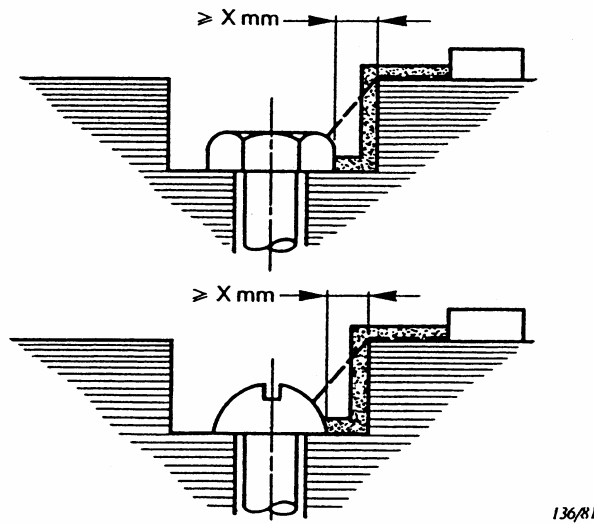

Gap between head of screw and wall of recess wide enough to be taken into account.

Example 10

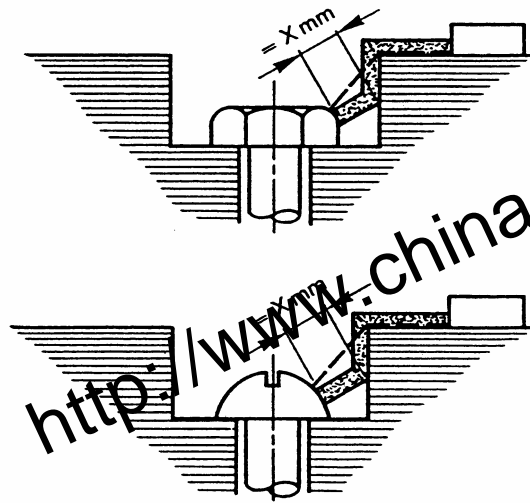

137/81

Gap between head of screw and wall of recess too narrow to be taken into account.

Measurement of creepage distance is from screw to wall when the distance is equal to X mm.



Example 11

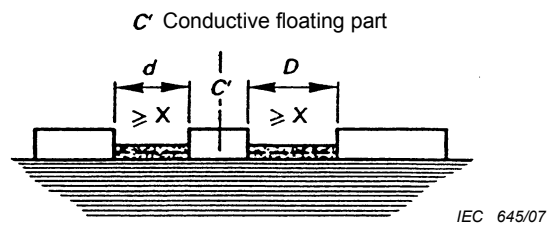

Clearance is the distance = $d + D$
 Creepage distance is also = $d + D$



Annex A
(informative)

Basic data on withstand characteristics of clearances

Table A.1 – Withstand voltages in kilovolts for an altitude of 2 000 m above sea level

Clearance mm	Case A Inhomogeneous field			Case B Homogeneous field	
	AC (50/60 Hz)		Impulse (1,2/50)	AC (50/60 Hz)	AC (50/60 Hz) and impulse (1,2/50)
	<i>U</i> r.m.s.	<i>U</i>	<i>U</i>	<i>U</i> r.m.s.	<i>U</i>
0,001	0,028	0,040	0,040	0,028	0,04
0,002	0,53	0,075	0,075	0,053	0,07
0,003	0,078	0,110	0,110	0,078	0,11
0,004	0,102	0,145	0,145	0,102	0,14
0,005	0,124	0,175	0,175	0,124	0,17
0,006 25	0,152	0,215	0,215	0,152	0,21
0,008	0,191	0,270	0,270	0,191	0,27
0,010	0,23	0,33+	0,33+	0,23	0,33
0,012	0,25	0,35	0,35	0,25	0,34
0,015	0,26	0,37	0,37	0,26	0,31
0,020	0,28	0,40	0,40	0,28	0,40
0,025	0,31	0,44	0,44	0,31	0,44
0,030	0,33	0,47	0,47	0,33	0,47
0,040	0,37	0,52	0,52	0,37	0,52
0,050	0,40	0,56	0,56	0,40	0,56
0,062 5	0,42	0,60+	0,60+	0,42	0,60
0,080	0,46	0,65	0,70	0,50	0,70
0,10	0,50	0,70	0,81	0,57	0,81
0,12	0,52	0,74	0,91	0,64	0,91
0,15	0,57	0,80	1,04+	0,74	1,04
0,20	0,62	0,88	1,15	0,89	1,24
0,25	0,67	0,95	1,23	1,03	1,44
0,30	0,71	1,01	1,31	1,15	1,62
0,40	0,78	1,11	1,44	1,38	1,94
0,50	0,84	1,19	1,55	1,59	2,24
0,60	0,90	1,27	1,65	1,79	2,51
0,80	0,98	1,39	1,81	2,15	3,04
1,0	1,06	1,50+	1,95	2,47	3,50
1,2	1,20	1,70	2,20	2,89	4,09
1,5	1,39	1,97	2,56	3,50	4,94
2,0	1,68	2,38	3,09	4,48	6,33
2,5	1,96	2,77	3,60	5,41	7,64
3,0	2,21	3,13	4,07	6,32	8,94
4,0	2,68	3,79	4,93	8,06	11,4
5,0	3,11	4,40	5,72	9,76	13,8
6,0	3,51	4,97	6,46	11,5	16,2
8,0	4,26	6,03	7,84	14,6	20,7
10,0	4,95	7,00+	9,10	17,7	25,0+
12,0	5,78	8,18	10,6	20,9	29,6
15,0	7,00	9,90	12,9	25,7	36,4
20,0	8,98	12,7	16,4	33,5	47,4
25,0	10,8	15,3	19,9	41,2	58,3
30,0	12,7	17,9	23,3	48,8	69,0
40,0	16,2	22,9	29,8	63,6	90,0
50,0	19,6	27,7	36,0	78,5	111,0
60,0	22,8	32,3	42,0	92,6	131,0
80,0	29,2	41,3	53,7	120,9	171,0

Table A.1 (continued)

Clearance	Case A Inhomogeneous field			Case B Homogeneous field	
	AC (50/60 Hz)		Impulse (1,2/50)	AC (50/60 Hz)	(50/60 Hz) and impulse (1,2/50)
mm	<i>U</i> r.m.s.	\hat{U}	\hat{U}	<i>U</i> r.m.s.	\hat{U}
100,0	35,4	50,0+	65,0	74,8	210,0+

NOTE The information for clearances from 0,001 mm to 0,100 mm, is issued from document "Electrical breakdown experiments in air for micrometer gaps under various pressures" from P. Hartherz, K. en Yahia, L. Müller, R. Pfendtner and W. Pfeiffer and issued during the 9th International Symposium on Gaseous Dielectrics, Ellicott City, Maryland, USA 2001, pp333-338.

More details can be found in the thesis of P. Hartherz "Anwendung der Teilentladungsmeßtechnik zur Fehleranalyse in festen Isolierungen unter periodischer Impulsspannungsbelastung". Dissertation TU Darmstadt; Shaker Verlag, 2002.

For simplification, the statistical measured values according to Table A.1 above are replaced by straight lines between the values marked "+" in a double logarithmic diagram taking into account the correction factors from 0 m to 2 000 m altitude. The intermediate values are taken from that diagram (see Figure A.1) so that they enclose the measured values with a small safety margin. The values of *U* r.m.s. are found by dividing the values of \hat{U} by $\sqrt{2}$.

Table A.2 – Altitude correction factors

Altitude m	Normal barometric pressure kPa	Multiplication factor for clearances
2 000	80,0	1,00
3 000	70,0	1,14
4 000	62,0	1,29
5 000	54,0	1,48
6 000	47,0	1,70
7 000	41,0	1,95
8 000	35,5	2,25
9 000	30,5	2,62
10 000	26,5	3,02
15 000	12,0	6,67
20 000	5,5	14,5

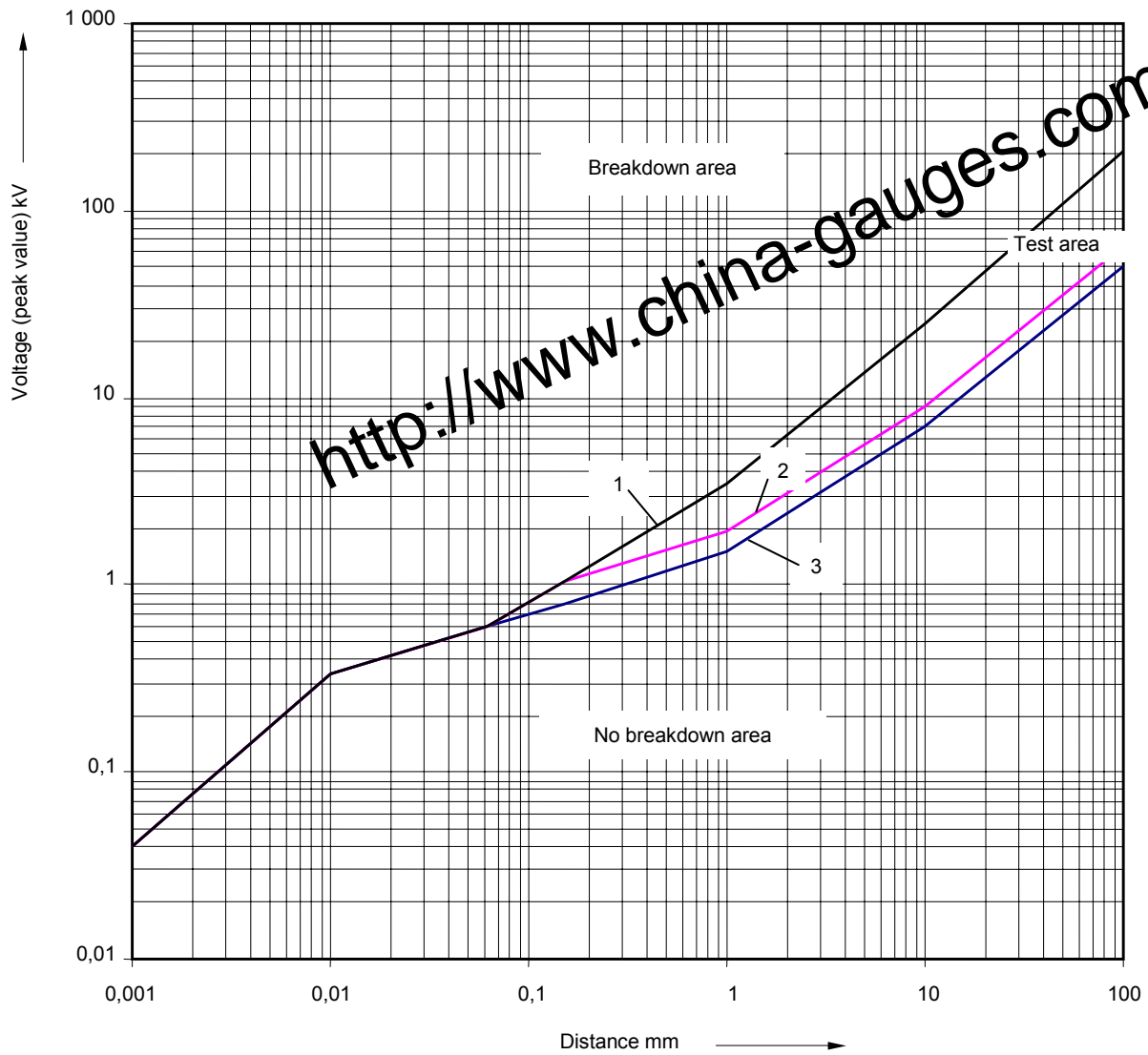

IEC 646/07

Key

- 1 case B; \hat{U} 1,2/50 and \hat{U} 50/60 Hz
- 2 case A; \hat{U} 1,2/50
- 3 case A; \hat{U} 50/60 Hz

Figure A.1 – Withstand voltage at 2 000 m above sea level

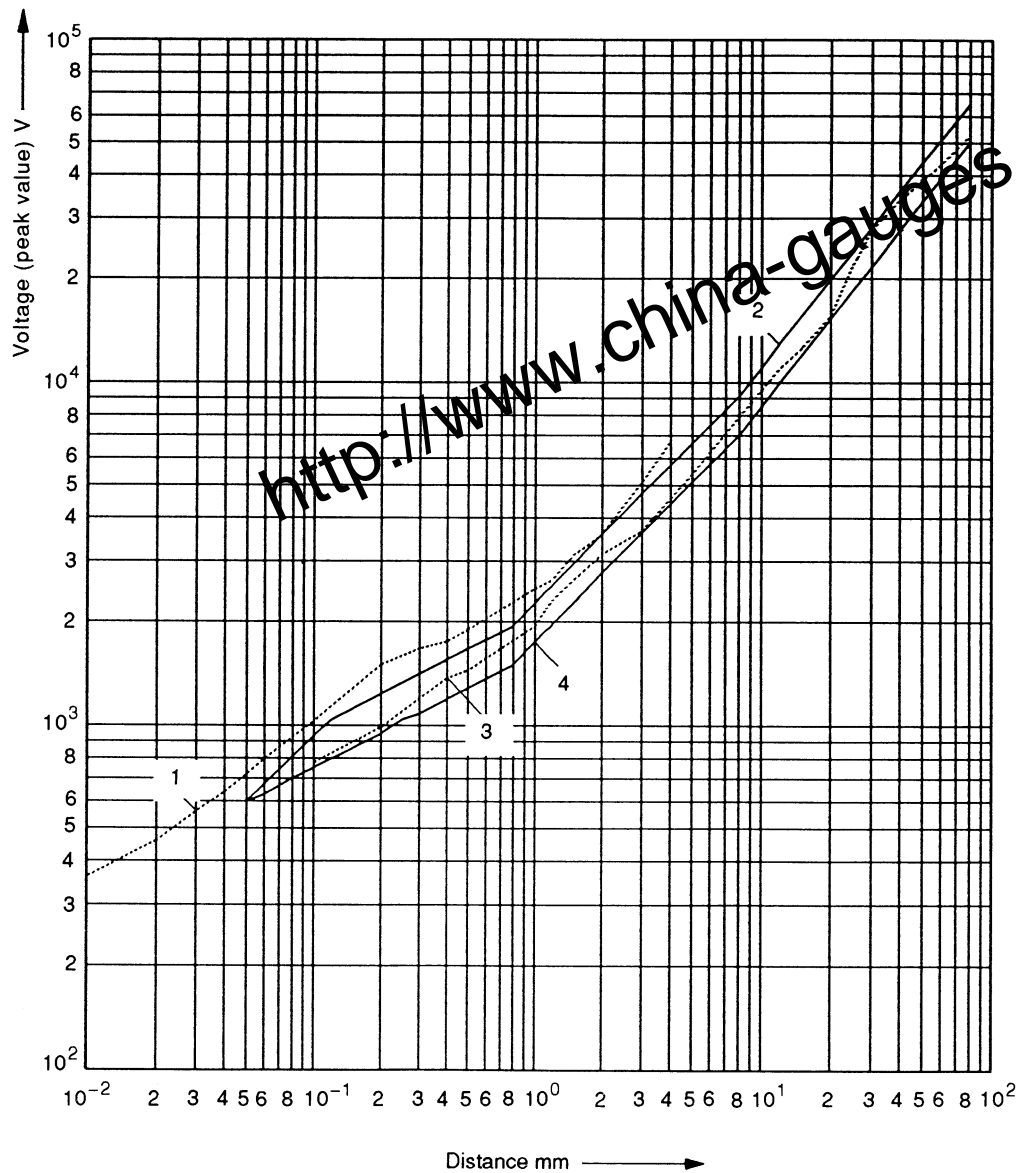

IEC 531/2000

Key

- 1 \hat{U} 1,2/50 according to ETZ-B, 1976 pp300-302 [3]
- 2 Low limits for \hat{U} 1,2/50
- 3 \hat{U} 50 Hz according to ETZ-A, 1969 pp251-255 [4]
- 4 Low limits for \hat{U} 50 Hz

Figure A.2 – Experimental data measured at approximately sea level and their low limits for inhomogeneous field

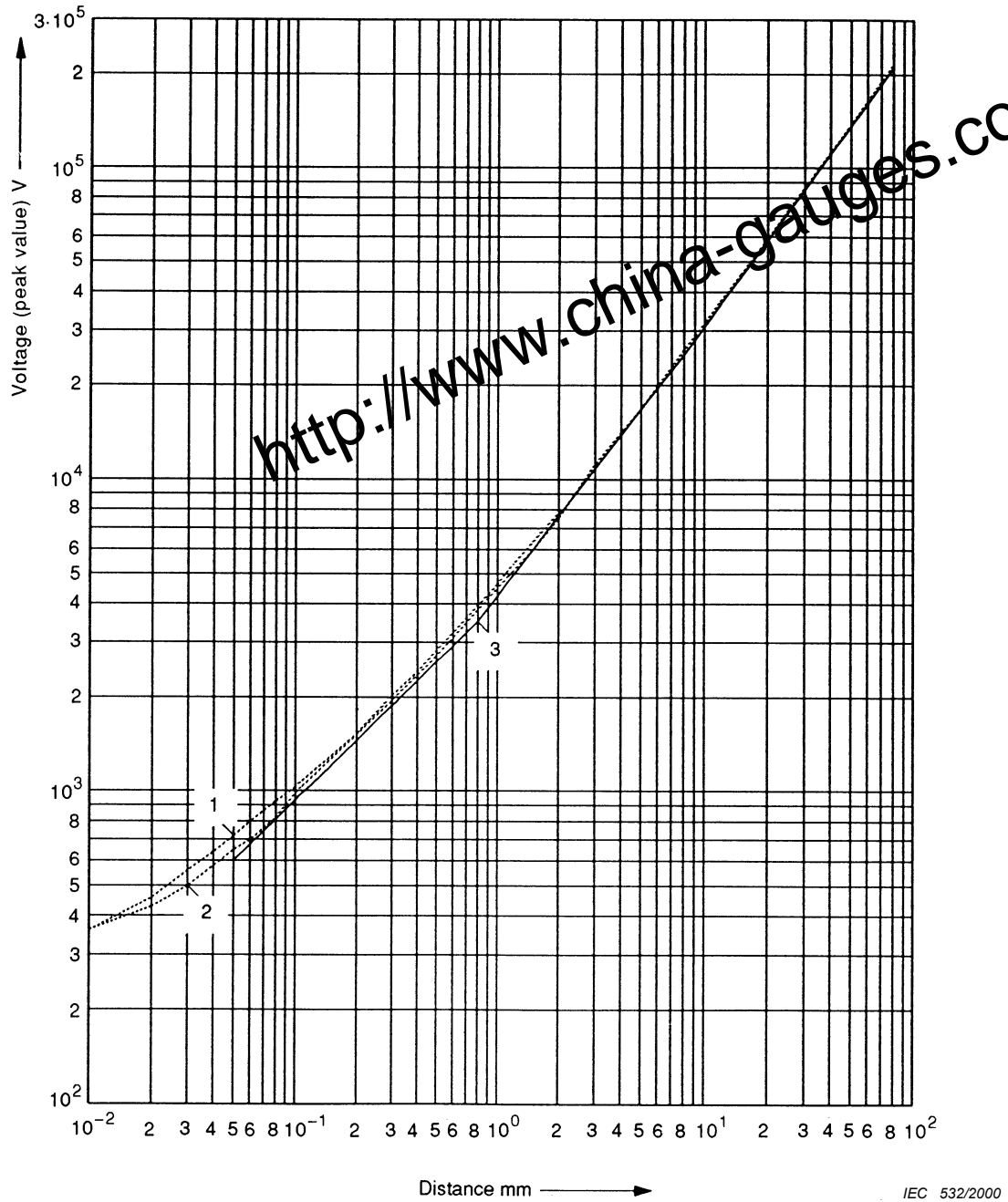

Key



- 1 \hat{U} 1,2/50 according to ETZ-B, 1976 pp300-302 [3]
- 2 \hat{U} 50 Hz according to Electra, 1974 pp61-82 [5]
- 3 Low limits for \hat{U} 1,2/50 and \hat{U} 50 Hz

Figure A.3 – Experimental data measured at approximately sea level and their low limits for homogeneous field

Annex B (informative)



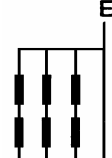
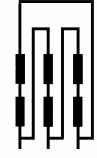

Nominal voltages of supply systems for different modes of overvoltage control

Table B.1 – Inherent control or equivalent protective control

Voltage line-to-neutral derived from nominal voltages a.c. or d.c. up to and including ¹⁾	Nominal voltages presently used in the world				Rated impulse voltage for equipment ¹⁾ V			
	Three-phase four-wire systems with earthed neutral 	Three-phase three-wire systems unearthed 	Single-phase two-wire systems a.c. or d.c. 	Single-phase three-wire systems a.c. or d.c. 				
	V	V	V	V	I	II	III	IV
50			12,5 24 25 30 42 48	30-60	330	500	800	1 500
100	66/115	66	60		500	800	1 500	2 500
150	120/208 * 127/220	115, 120, 127	100 **, 110, 120	100-200 ** 110-220 120-240	800	1 500	2 500	4 000
300	220/380, 230/400 240/415, 260/440 277/480	200 **, 220, 230, 240, 260, 277, 347 380, 400, 415 440, 480	220	220-440	1 500	2 500	4 000	6 000
600	347/600, 380/660 400/690, 417/720 480/830	500, 577, 600	480	480-960	2 500	4 000	6 000	8 000
1 000		660 690, 720 830, 1 000	1 000		4 000	6 000	8 000	12 000

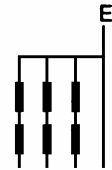
¹⁾ These columns are taken from Table F.1 in which the rated impulse voltage values are specified.
* Practice in the United States of America and in Canada.
** Practice in Japan.

Table B.2 – Cases where protective control is necessary and control is provided by surge arresters having a ratio of clamping voltage to rated voltage not smaller than that specified by IEC 60099-1

Voltage line-to-neutral derived from nominal voltages a.c. or d.c. up to and including 1)	Nominal voltages presently used in the world				Rated impulse voltage for equipment 1) V			
	Three-phase four-wire systems with earthed neutral 	Three-phase three-wire systems earthed or unearthed 	Single-phase two-wire systems a.c. or d.c. 	Single-phase three-wire systems a.c. or d.c. 				
	V	V	V	V	I	II	III	IV
50			12,5 24 25 30 42 48	30-60	330	500	800	1 500
100	66/115	66	60		500	800	1 500	2 500
150	120/208 * 127/220	115, 120, 127	100 ** 110, 120	100-200 ** 110-220 120-240	800	1 500	2 500	4 000
300	220/380, 230/400 240/415, 260/440 277/480	200 **, 220, 230, 240 260, 277	220	220-440	1 500	2 500	4 000	6 000
600	347/600, 380/660 400/690, 417/720 480/830	347, 380, 400 415, 440, 480 500, 577, 600	480	480-960	2 500	4 000	6 000	8 000
1 000		660 690, 720 830, 1 000	1 000		4 000	6 000	8 000	12 000

1) These columns are taken from Table F.1 in which the rated impulse voltage values are specified.
* Practice in the United States of America and in Canada.
** Practice in Japan.

Annex C (normative)

Partial discharge test methods

C.1 Test circuits

C.1.1 General

Test circuits shall perform as described in IEC 60270. The following circuits given in this annex meet those requirements and are given as examples.

NOTE 1 In the majority of cases, testing equipment designed in accordance with the examples given in this annex will be sufficient. In special cases, for example in presence of extremely high ambient noise, it may be necessary to refer to IEC 60270.

NOTE 2 For an explanation of the basic operation, see Clause D.2.

C.1.2 Test circuit for earthed test specimen

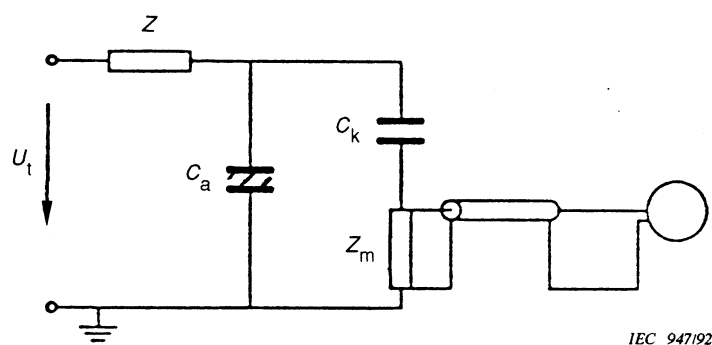

Key

- U_t test voltage
- Z filter
- C_a test specimen (usually it can be regarded as a capacitance)
- C_k coupling capacitor
- Z_m measuring impedance

Figure C.1 – Earthed test specimen

C.1.3 Test circuit for unearthed test specimen

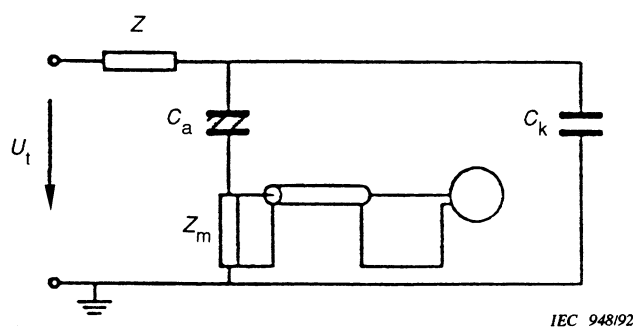

Figure C.2 – Unearthed test specimen

C.1.4 Selection criteria

Basically both circuits are equivalent. However the stray capacitances of the test specimen have a different influence upon sensitivity. The earth capacitance of the high-voltage terminal of the test specimen tends to reduce the sensitivity of the circuit according to C.1.2 and tends to increase the sensitivity of the circuit according to C.1.3 which therefore should be preferred.

C.1.5 Measuring impedance

The measuring impedance shall provide a negligibly low voltage drop at test frequency. The impedance for the measuring frequency shall be selected in order to provide a reasonable sensitivity according to Clause D.2.

If voltage limiting components are used they shall not be effective within the measuring range.

C.1.6 Coupling capacitor C_k

This capacitor shall be of low inductance type with a resonant frequency in excess of $3 f_2$ (see Clause C.3). It shall be free of partial discharges up to the highest test voltage used.

C.1.7 Filter

The use of a filter is not mandatory. If used, its impedance shall be high for the measuring frequency.

C.2 Test parameters

C.2.1 General

Technical committees shall specify

- the frequency f_t of the test voltage (C.2.2),
- the specified discharge magnitude (6.1.3.5.4.1),
- the climatic conditions for the PD test (C.2.3).

NOTE It may be necessary to have different specifications for the type test and the routine test.

C.2.2 Requirements for the test voltage

Normally a.c. voltages are used. The total harmonic distortion shall be less than 3 %.

NOTE 1 Low distortion of the sine wave allows the use of standard voltmeters and the calculation of the peak value from the r.m.s. reading. In the case of higher distortion, peak voltmeters should be used.

Tests are normally made at power frequency. If other frequencies are present in the equipment, technical committees shall consider the possible effect of frequency on discharge magnitude.

NOTE 2 PD testing with d.c. voltage is not recommended because of the difficulty of achieving an environment which is completely free of electrical noise. In addition it should be noted that the voltage distribution is greatly different for a.c. and d.c.

C.2.3 Climatic conditions

It is recommended to perform the test at room temperature and average humidity (23 °C, 50 % r.h., see 5.3 of IEC 60068-1).

C.3 Requirements for measuring instruments

C.3.1 General

Both wideband and narrowband charge measuring instruments may be used (see C.3.3). Radio interference voltmeters may only be used according to the precautions given in C.3.2.

The lower limit of the measuring frequency is determined by the measuring frequency f_t of the test voltage and the frequency characteristic of the measuring impedance Z_m (see C.1.5). It should not be lower than $10 f_t$.

The upper limit of the measuring frequency is determined by the shape of the PD pulses and the frequency response of the test circuit. It does not need to be higher than 2 MHz. For narrowband PD meters the measuring frequency shall be selected with regard to narrowband noise sources (see D.3.3).

NOTE Narrowband PD meters are recommended.

C.3.2 Classification of PD meters

The current through the measuring impedance Z_m is integrated to provide a reading proportional to q_m (see Figure D.1).

The integration can be effected by the measuring impedance. In this case it shall represent a capacitance for all frequencies above the lower limit of the measuring frequency. The voltage across the capacitance, which is proportional to q_m , is amplified by a pulse amplifier. Periodic discharging shall also be provided.

If the measuring impedance is resistive for all frequencies above the lower limit of the measuring frequency, the integration shall be done within the pulse amplifier.

Single pulses shall be measured and the pulse with the maximum amplitude shall be evaluated. In order to limit errors due to pulse overlap, the pulse resolution time shall be less than 100 μ s.

Radio interference meters are narrowband peak voltage meters. They are used to measure interference of radio signals. They incorporate a special filter circuit which creates dependency of the reading on the pulse repetition rate according to the subjective effect of noise to the human ear.

For measuring partial discharges, radio interference meters may only be used if the filter circuit is disconnected. Also a suitable measuring impedance is required.

C.3.3 Bandwidth of the test circuit

Usually, the PD meter limits the bandwidth of the test circuit. PD meters are classified according to their bandwidth as wideband or narrowband.

- a) The lower and the upper cut-off frequencies f_1 and f_2 are those where the frequency response has dropped by 3 dB of the constant value in the case of a wideband meter and by 6 dB from the peak value in the case of a narrowband meter.
- b) For narrowband meters, the measuring frequency f_0 is identical with the resonance peak in the frequency response.
- c) The bandwidth Δf is:

$$\Delta f = f_2 - f_1$$

For wideband meters, Δf is in the same order of magnitude as f_2 . For narrowband meters,

Δf is much less than f_0 .

C.4 Calibration

C.4.1 Calibration of discharge magnitude before the noise level measurement

The calibration of the test circuit (Figure C.3 or Figure C.4) shall be carried out at the specified discharge magnitude replacing the test specimen C_a by a capacitor C_x which exhibits no partial discharge. The impedance of the capacitor C_x shall be similar to that of the test specimen C_a .

The transformers shall be adjusted according to the specified PD test voltage but not energized and their primary windings shall be short-circuited. The specified discharge magnitude shall be applied to the terminals of the capacitor by means of the calibration pulse generator. The indication of the discharge magnitude on the discharge detector shall be adjusted to correspond with the calibration signal.

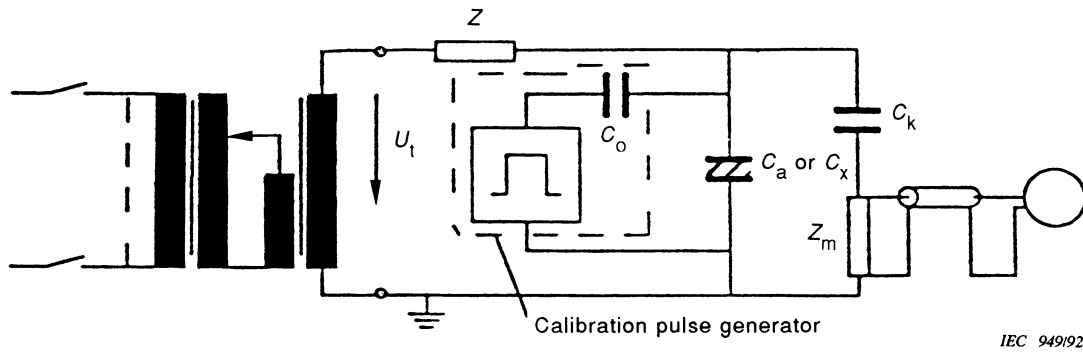

IEC 949/92

Key

- U_t test voltage
- Z filter
- C_0 capacitance of the calibration impulse generator
- C_a or C_x test specimen (usually it can be regarded as a capacitance)
- C_k coupling capacitor
- Z_m measuring impedance

Figure C.3 – Calibration for earthed test specimen

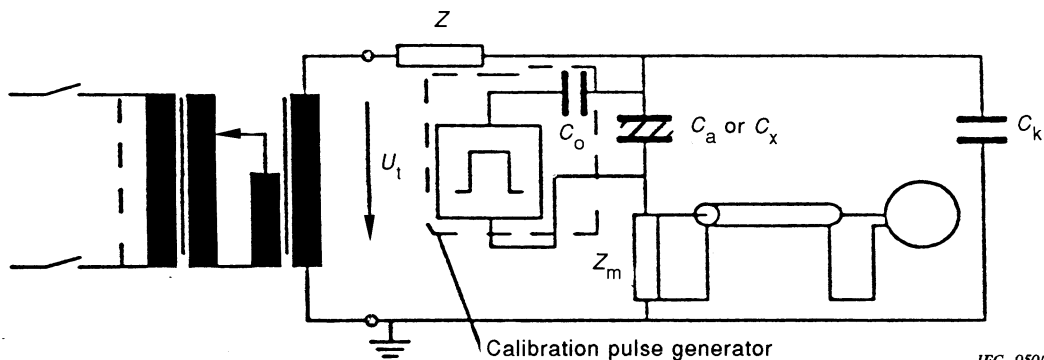

IEC 950/92

Figure C.4 – Calibration for unearthed test specimen

C.4.2 Verification of the noise level

With the arrangement used in C.4.1 the PD test voltage shall be raised up to the highest test voltage. The maximum noise level shall be less than 50 % of the specified discharge magnitude. Otherwise measures according to Clause D.3 are required.

C.4.3 Calibration for the PD test

With the test specimen in circuit, the procedure of C.4.1 shall be repeated.

Changes in test circuit or test specimen require recalibration. In the case of many similar test specimens, occasional recalibration may be sufficient if

- the impedance of the coupling capacitor is less than 1/10 of that of the test specimen, or
- the impedance of the test specimen does not deviate from the value during calibration by more than ± 10 %.

NOTE When specifying time intervals for recalibration, technical committees should bear in mind that, in case of insufficient sensitivity at the PD meter, potentially harmful discharges cannot be detected.

C.4.4 Calibration pulse generator

Basically it consists of a small capacitance C_0 which has been charged to U_0 .

The current pulses caused by the pulse generator should have a rise time of less than $0,03 / f_2$. C_0 shall have no higher value than $0,1 C_k$. The tail time of the pulse should be greater than 100 μ s.

To verify the performance of the PD meter, it shall be calibrated in all measuring ranges. The measuring impedance and the connecting cables shall be included in the procedure.

The following characteristics shall be checked:

- the precision and the stability of the calibration pulse generator;
- the reading for pulses of different amplitudes at a pulse repetition rate of 100 Hz;
- the pulse resolution time by using pulses of constant amplitude and increasing repetition rate;
- the lower and upper cut-off frequencies f_1 and f_2 .

This procedure shall follow each time repairs are carried out on the PD meter but it shall in any case take place at least once a year.

Annex D
(informative)

Additional information on partial discharge test methods

D.1 Measurement of PD inception and extinction voltage

The test voltage is increased from a value below the partial discharge inception voltage until partial discharges occur (PD inception voltage U_i). After further increase of the test voltage by 10 %, the voltage is decreased until PD is smaller than the specified discharge magnitude (PD extinction voltage U_e). Thereby the insulation test voltage specified for the test specimen may not be exceeded.

NOTE It may occur that the partial discharge extinction voltage is influenced by the time of the voltage stress with values exceeding the partial discharge inception voltage. During successive measurements, both U_i and U_e may be influenced.

This procedure is appropriate for investigation measurements.

D.2 Description of PD test circuits

Each circuit consists of the following devices:

- the test specimen C_a (in special cases it may also be an impedance Z_a);
- the coupling capacitor C_k ;
- the measuring circuit consisting of measuring impedance Z_m , the connecting cable and the PD meter;
- optionally a filter Z to reduce charge being bypassed by the test voltage source.

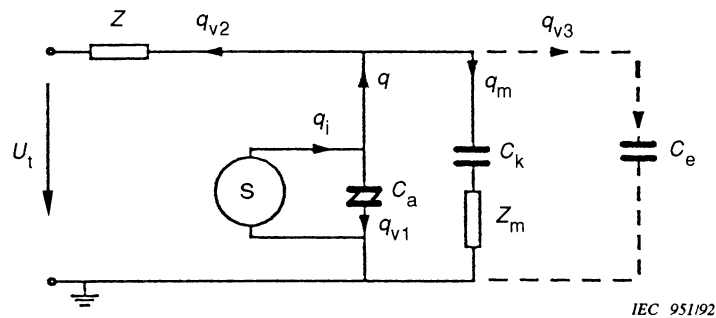

Key

U_t	test voltage	q_i	internal charge (not measurable)
Z	filter	q	apparent charge
S	PD current source	q_m	measurable charge
C_a	capacitance of the test specimen	q_{v1}	charge loss across the test specimen
C_k	coupling capacitor	q_{v2}	charge loss across the test voltage source
Z_m	measuring impedance	q_{v3}	charge loss across the earth stray capacitance
C_e	earth stray capacitance		

Figure D.1 – Partial discharge test circuits

The direct measurement of the apparent charge q would require a short-circuit at the

terminals of the test specimen for the measuring frequency. This condition can be approximated as follows:

- $C_k > (C_a + C_e)$;
- high impedance Z ;
- low measuring impedance Z_m .

Otherwise significant charge losses q_{V2} and q_{V3} may occur. These charge losses are taken into account by the calibration but they will limit the sensitivity. The situation is aggravated if the test specimen has a high capacitance.

D.3 Precautions for reduction of noise

D.3.1 General

The results of PD measurements may be greatly influenced by noise. Such noise may be introduced by conductive coupling or by electromagnetic interference. In unscreened industrial test sites, single charge pulses as high as 100 pC may occur due to noise. Even under favourable conditions, not less than 20 pC may be expected.

A noise level as low as 1 pC may be achieved, but this will require screening of the test circuit, careful earthing measures and filtering of the low-voltage mains input.

D.3.2 Sources of noise

Basically there are two different kinds of noise sources.

D.3.2.1 Sources in the non-energized test circuit

These are caused for instance by switching in adjacent circuits. In case of conductive coupling they only occur if connection to the low-voltage mains supply is provided. In case of electromagnetic coupling they also occur if the mains supply is switched off (including the protective conductor).

D.3.2.2 Sources in the energized test circuit

Usually, noise increases with the test voltage and is caused by partial discharges outside the test specimen. PD may occur in the test transformer, the high-voltage connecting leads, bushings and points of poor contact. Harmonics of the test voltage may also contribute to the noise level.

D.3.3 Measures for reduction of noise

Noise caused by conductive coupling can be reduced by use of line filters in the central feeding of the test circuit. No earth loops should be present.

Electromagnetic interference, for instance by radio signals, can be excluded in a simple manner by variation of the measuring frequency f_0 for narrowband PD meters. For wideband PD meters, band-stop-filters may be required, wideband signals can only be suppressed by screening. The highest efficiency is provided by a fully enclosed screen with high electrical conductivity.

D.4 Application of multiplying factors for test voltages

D.4.1 General

The values of the multiplying factors defined in 6.1.3.5 and used in 5.3.3.2.4 and 6.1.3.5 are calculated as follows:

NOTE These examples are given for the recurring peak voltage U_{rp} . The factors similarly apply to the highest steady-state voltage and to the long-term temporary overvoltage.

D.4.2 Example 1

Circuit connected to the low-voltage mains.

D.4.2.1 Maximum recurring peak voltage U_{rp}

$$U_{rp} = \sqrt{2} U_n \times F_4 = 1,1 \sqrt{2} U_n$$

D.4.2.2 PD extinction voltage U_e (basic insulation)

$$U_e = \sqrt{2} U_n \times F_4 \times F_1$$

$$U_e = \sqrt{2} U_n \times 1,1 \times 1,2 = 1,32 \sqrt{2} U_n$$

D.4.2.3 Initial value of the PD test voltage U_1 (basic insulation)

$$U_1 = \sqrt{2} U_n \times F_4 \times F_1 \times F_2$$

$$U_1 = \sqrt{2} U_n \times 1,32 \times 1,25 = 1,65 \sqrt{2} U_n$$

D.4.3 Example 2

Internal circuit with maximum recurring peak voltage U_{rp} .

D.4.3.1 PD extinction voltage U_e (basic insulation)

$$U_e = U_{rp} \times F_1 = U_{rp} \times 1,2$$

D.4.3.2 Initial value of the PD test voltage (basic insulation)

$$U_1 = U_{rp} \times F_1 \times F_2 = U_{rp} \times 1,5$$

Annex E
(informative)

**Comparison of creepage distances specified in Table F.4
and clearances in Table A.1**

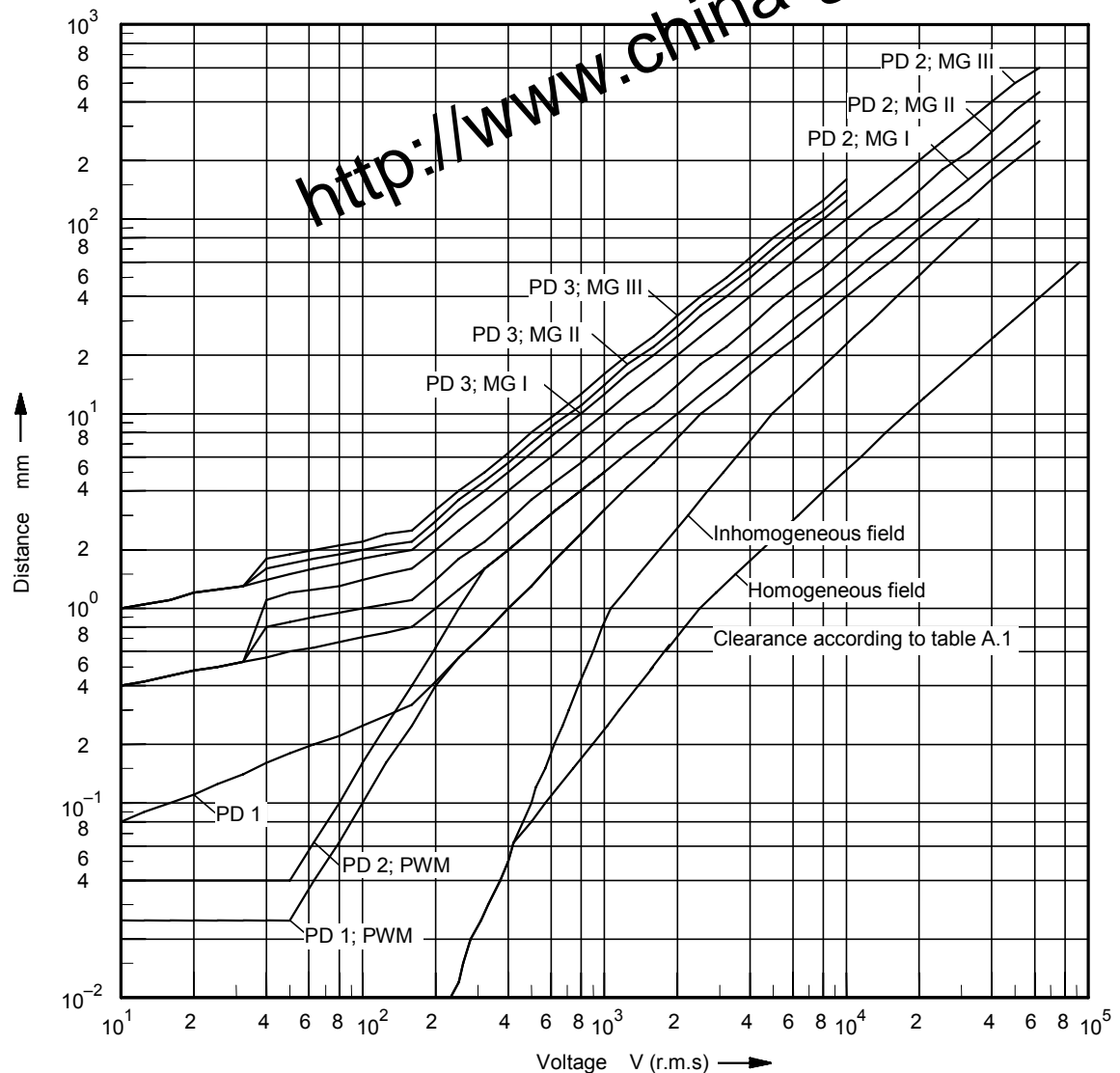

IEC 1208/02

Key

- PD pollution degree
- MG material group
- PWM printed wiring material

**Figure E.1 – Comparison between creepage distances specified in Table F.4
and clearances in Table A.1**

Annex F
(normative)

Tables

Table F.1 – Rated impulse voltage for equipment energized directly from the low-voltage mains

Nominal voltage of the supply system ¹⁾ based on IEC 60038 ³⁾		Voltage line to neutral derived from nominal voltages a.c. or d.c. up to and including V	Rated impulse voltage ²⁾			
Three phase V	Single phase V		Overvoltage category ⁴⁾			
			I V	II V	III V	IV V
		50	330	500	800	1 500
		100	500	800	1 500	2 500
	120-240	150 ⁵⁾	800	1 500	2 500	4 000
230/400 277/480		300	1 500	2 500	4 000	6 000
400/690		600	2 500	4 000	6 000	8 000
1 000		1 000	4 000	6 000	8 000	12 000

1) See Annex B for application to existing different low-voltage mains and their nominal voltages.
 2) Equipment with these rated impulse voltages can be used in installations in accordance with IEC 60364-4-44.
 3) The / mark indicates a four-wire three-phase distribution system. The lower value is the voltage line-to-neutral, while the higher value is the voltage line-to-line. Where only one value is indicated, it refers to three-wire, three-phase systems and specifies the value line-to-line.
 4) See 4.3.3.2.2 for an explanation of the overvoltage categories.
 5) Nominal voltages for single-phase systems in Japan are 100 V or 100-200 V. However, the value of the rated impulse voltage for the voltages is determined from columns applicable to the voltage line to neutral of 150 V (See Annex B).

Table F.2 – Clearances to withstand transient overvoltages

Required impulse withstand voltage ^{1) 5)}	Minimum clearances in air up to 2 000 m above sea level					
	Case A Inhomogeneous field (see 3.15)			Case B Homogeneous field (see 3.14)		
	Pollution degree ⁶⁾			Pollution degree ⁶⁾		
kV	1 mm	2 mm	3 mm	1 mm	2 mm	3 mm
0,33 ²⁾	0,01	0,2 ^{3) 4)}	0,8 ⁴⁾	0,01	0,2 ^{3) 4)}	0,8 ⁴⁾
0,40	0,02			0,02		
0,50 ²⁾	0,04			0,04		
0,60	0,06			0,06		
0,80 ²⁾	0,10			0,10		
1,0	0,15			0,15		
1,2	0,25			0,25		
1,5 ²⁾	0,5	0,5	0,3	0,3		
2,0	1,0	1,0	1,0	0,45	0,45	
2,5 ²⁾	1,5	1,5	1,5	0,60	0,60	
3,0	2,0	2,0	2,0	0,80	0,80	
4,0 ²⁾	3,0	3,0	3,0	1,2	1,2	1,2
5,0	4,0	4,0	4,0	1,5	1,5	1,5
6,0 ²⁾	5,5	5,5	5,5	2,0	2,0	2,0
8,0 ²⁾	8,0	8,0	8,0	3,0	3,0	3,0
10	11	11	11	3,5	3,5	3,5
12 ²⁾	14	14	14	4,5	4,5	4,5
15	18	18	18	5,5	5,5	5,5
20	25	25	25	8,0	8,0	8,0
25	33	33	33	10	10	10
30	40	40	40	12,5	12,5	12,5
40	60	60	60	17	17	17
50	75	75	75	22	22	22
60	90	90	90	27	27	27
80	130	130	130	35	35	35
100	170	170	170	45	45	45

1) This voltage is
– for functional insulation, the maximum impulse voltage expected to occur across the clearance (see 5.1.5),
– for basic insulation directly exposed to or significantly influenced by transient overvoltages from the low-voltage mains (see 4.3.3.3, 4.3.3.4.1 and 5.1.6), the rated impulse voltage of the equipment,
– for other basic insulation (see 4.3.3.4.2), the highest impulse voltage that can occur in the circuit.
For reinforced insulation see 5.1.6.

2) Preferred values as specified in 4.2.3.

3) For printed wiring material, the values for pollution degree 1 apply except that the value shall not be less than 0,04 mm, as specified in Table F.4.

4) The minimum clearances given for pollution degrees 2 and 3 are based on the reduced withstand characteristics of the associated creepage distance under humidity conditions (see IEC 60664-5).

5) For parts or circuits within equipment subject to impulse voltages according to 4.3.3.4.2, interpolation of values is allowed. However, standardization is achieved by using the preferred series of impulse voltage values in 4.2.3.

6) The dimensions for pollution degree 4 are as specified for pollution degree 3, except that the minimum clearance is 1,6 mm.

Table F.3a – Single-phase three or two-wire a.c. or d.c. systems

Nominal voltage of the supply system *	Voltages rationalized for Table F.4	
	For insulation line-to-line ¹⁾	For insulation line-to-earth ¹⁾
	All systems V	Three-wire systems mid-point earthed V
V	V	
12,5	12,5	
24 25	25	
30	32	
42 48 50 **	50	
60	63	
30-60	63	32
100 **	100	
110 120	125	
150 **	160	
200	200	
100-200	200	100
220	250	
110-220 120-240	250	125
300 **	320	
220-440	500	250
600 **	630	
480-960	1 000	500
1 000 **	1 000	
<p>¹⁾ Line-to-earth insulation level for unearthed or impedance-earthed systems equals that for line-to-line because the operating voltage to earth of any line can, in practice, approach full line-to-line voltage. This is because the actual voltage to earth is determined by the insulation resistance and capacitive reactance of each line to earth; thus, low (but acceptable) insulation resistance of one line can in effect earth it and raise the other two to full line-to-line voltage to earth.</p> <p>* For relationship to rated voltage see 4.3.2.</p> <p>** These values correspond to the values given in Table F.1.</p>		

<http://www.china-gauges.com/>

Table F.3b – Three-phase four or three-wire a.c. systems

Nominal voltage of the supply system *	Voltages rationalized for Table F.4		
	For insulation line-to-line	For insulation line-to-earth	
	All systems	Three-phase four-wire systems neutral-earthed ²⁾	Three-phase three-wire systems (unearthed ¹⁾ or corner-earthed
V	V	V	V
60	63	32	63
110 120 127	125	80	125
150 **	160	–	160
200	200		200
208	200	125	200
220 230 240	250	160	250
300 **	320	–	320
380 400 415	400	250	400
440	500	250	500
480 500	500	320	500
575	630	400	630
600 **	630	–	630
660 690	630	400	630
720 830	800	500	800
960	1 000	630	1 000
1 000 **	1 000	–	1 000

1) Line-to-earth insulation level for unearthed or impedance-earthed systems equals that for line-to-line because the operating voltage to earth of any line can, in practice, approach full line-to-line voltage. This is because the actual voltage to earth is determined by the insulation resistance and capacitive reactance of each line to earth; thus, low (but acceptable) insulation resistance of one line can in effect earth it and raise the other two to full line-to-line voltage to earth.

2) For equipment for use on both three-phase four-wire and three-phase three-wire supplies, earthed and unearthed, use the values for three-wire systems only.

* For relationship to rated voltage see 4.3.2.

** These values correspond to the values given in Table F.1.

Table F.4 – Creepage distances to avoid failure due to tracking

Voltage r.m.s. ¹⁾	Minimum creepage distances								
	Printed wiring material		Pollution degree						
	1	2	1	2			3		
	All material groups	All material groups, except IIIb	All material groups	Material group I	Material group II	Material group III	Material group I	Material group II	Material group III ²⁾
V	mm	mm	mm	mm	mm	mm	mm	mm	mm
10	0,025	0,040	0,080	0,400	0,400	0,400	1,000	1,000	1,000
12,5	0,025	0,040	0,090	0,420	0,420	0,420	1,050	1,050	1,050
16	0,025	0,040	0,100	0,450	0,450	0,450	1,100	1,100	1,100
20	0,025	0,040	0,110	0,480	0,480	0,480	1,200	1,200	1,200
25	0,025	0,040	0,125	0,500	0,500	0,500	1,250	1,250	1,250
32	0,025	0,040	0,14	0,53	0,53	0,53	1,30	1,30	1,30
40	0,025	0,040	0,16	0,56	0,80	1,10	1,40	1,60	1,80
50	0,025	0,040	0,18	0,60	0,85	1,20	1,50	1,70	1,90
63	0,040	0,063	0,20	0,63	0,90	1,25	1,60	1,80	2,00
80	0,063	0,100	0,22	0,67	0,95	1,30	1,70	1,90	2,10
100	0,100	0,160	0,25	0,71	1,00	1,40	1,80	2,00	2,20
125	0,160	0,250	0,28	0,75	1,05	1,50	1,90	2,10	2,40
160	0,250	0,400	0,32	0,80	1,10	1,60	2,00	2,20	2,50
200	0,400	0,630	0,42	1,00	1,40	2,00	2,50	2,80	3,20
250	0,560	1,000	0,56	1,25	1,80	2,50	3,20	3,60	4,00
320	0,75	1,60	0,75	1,60	2,20	3,20	4,00	4,50	5,00
400	1,0	2,0	1,0	2,0	2,8	4,0	5,0	5,6	6,3
500	1,3	2,5	1,3	2,5	3,6	5,0	6,3	7,1	8,0 (7,9) ⁴⁾
630	1,8	3,2	1,8	3,2	4,5	6,3	8,0 (7,9) ⁴⁾	9,0 (8,4) ⁴⁾	10,0 (9,0) ⁴⁾
800	2,4	4,0	2,4	4,0	5,6	8,0	10,0 (9,0) ⁴⁾	11,0 (9,6) ⁴⁾	12,5 (10,2) ⁴⁾
1 000	3,2	5,0	3,2	5,0	7,1	10,0	12,5 (10,2) ⁴⁾	14,0 (11,2) ⁴⁾	16,0 (12,8) ⁴⁾
1 250			4,2	6,3	9,0	12,5	16,0 (12,8) ⁴⁾	18,0 (14,4) ⁴⁾	20,0 (16,0) ⁴⁾
1 600			5,6	8,0	11,0	16,0	20,0 (16,0) ⁴⁾	22,0 (17,6) ⁴⁾	25,0 (20,0) ⁴⁾
2 000			7,5	10,0	14,0	20,0	25,0 (20,0) ⁴⁾	28,0 (22,4) ⁴⁾	32,0 (25,6) ⁴⁾
2 500			10,0	12,5	18,0	25,0	32,0 (25,6) ⁴⁾	36,0 (28,8) ⁴⁾	40,0 (32,0) ⁴⁾
3 200			12,5	16,0	22,0	32,0	40,0 (32,0) ⁴⁾	45,0 (36,0) ⁴⁾	50,0 (40,0) ⁴⁾

Table F.4 (continued)

Voltage r.m.s. ¹⁾ V	Minimum creepage distances								
	Printed wiring material		Pollution degree						
	1	2	1	2			3		
	All material groups	All material groups, except IIIb	All material groups	Material group I	Material group II	Material group III	Material group I	Material group II	Material group III ²⁾
mm	mm	mm	mm	mm	mm	mm	mm	mm	
4 000			16,0	20,0	28,0	40,0	50,0 (40,0) ⁴⁾	56,0 (44,8) ⁴⁾	63,0 (50,4) ⁴⁾
5 000			17,0	25,0	36,0	50,0	63,0 (50,4) ⁴⁾	71,0 (56,8) ⁴⁾	80,0 (64,0) ⁴⁾
6 300			25,0	32,0	45,0	63,0	80,0 (64,0) ⁴⁾	90,0 (72,0) ⁴⁾	100,0 (80,0) ⁴⁾
8 000			32,0	40,0	56,0	80,0	100,0 (80,0) ⁴⁾	110,0 (88,0) ⁴⁾	125,0 (100,0) ⁴⁾
10 000			40,0	50,0	71,0	100,0	125,0 (100,0) ⁴⁾	140,0 (112,0) ⁴⁾	160,0 (128,0) ⁴⁾
12 500			50,0 ³⁾	63,0 ³⁾	90,0 ³⁾	125,0 ³⁾			
16 000			63,0 ³⁾	80,0 ³⁾	110,0 ³⁾	160,0 ³⁾			
20 000			80,0 ³⁾	100,0 ³⁾	140,0 ³⁾	200,0 ³⁾			
25 000			100,0 ³⁾	125,0 ³⁾	180,0 ³⁾	250,0 ³⁾			
32 000			125,0 ³⁾	160,0 ³⁾	220,0 ³⁾	320,0 ³⁾			
40 000			160,0 ³⁾	200,0 ³⁾	280,0 ³⁾	400,0 ³⁾			
50 000			200,0 ³⁾	250,0 ³⁾	360,0 ³⁾	500,0 ³⁾			
63 000			250,0 ³⁾	320,0 ³⁾	450,0 ³⁾	600,0 ³⁾			

¹⁾ This voltage is

- for functional insulation, the working voltage,
- for basic and supplementary insulation of the circuit energized directly from the supply mains (see 4.3.2.2.1), the voltage rationalized through Table F.3a or Table F.3b, based on the rated voltage of the equipment, or the rated insulation voltage,
- for basic and supplementary insulation of systems, equipment and internal circuits not energized directly from the mains (see 4.3.2.2.2), the highest r.m.s. voltage which can occur in the system, equipment or internal circuit when supplied at rated voltage and under the most onerous combination of conditions of operation within equipment rating.

²⁾ Material group IIIb is not recommended for application in pollution degree 3 above 630 V.

³⁾ Provisional data based on extrapolation. Technical committees who have other information based on experience may use their dimensions.

⁴⁾ The values given in brackets may be applied to reduce the creepage distance in case of using a rib (see 5.2.5).

NOTE The high precision for creepage distances given in this table does not mean that the uncertainty of measurement has to be in the same order of magnitude.

Table F.5 – Test voltages for verifying clearances at different altitudes

The voltage values of Table F.5 apply for the verification of clearances only.

Rated impulse voltage \hat{U} kV	Impulse test voltage at sea level \hat{U} kV	Impulse test voltage at 200 m altitude \hat{U} kV	Impulse test voltage at 500 m altitude \hat{U} kV
0,33	0,357	0,357	0,350
0,5	0,541	0,537	0,531
0,8	0,934	0,920	0,899
1,5	1,751	1,725	1,685
2,5	2,923	2,874	2,808
4,0	4,923	4,824	4,675
6,0	7,385	7,236	7,013
8,0	9,847	9,648	9,350
12,0	14,770	14,471	14,025

NOTE 1 Explanations concerning the influencing factors (air pressure, altitude, temperature, humidity) with respect to electric strength of clearances are given in 6.1.2.2.1.3.

NOTE 2 When testing clearances, associated solid insulation will be subjected to the test voltage. As the impulse test voltage of Table F.5 is increased with respect to the rated impulse voltage, solid insulation will have to be designed accordingly. This results in an increased impulse withstand capability of the solid insulation.

Table F.6 – Severities for conditioning of solid insulation

Test	Temperature °C	Relative humidity %	Time h	Number of cycles
a) Dry heat	+55	–	48	1
b) Dry heat cycle	–10 to +55	–	Cycle duration 24	3
c) Thermal shock (rapid change of temperature)	–10 to +55	–	2)	
d) Damp heat	30/40 ¹⁾	93	96	1

¹⁾ Standard temperature of damp heat test appears in IEC 60068-2-78.

²⁾ Duration of the temperature change depends on the thermal time constant of the test specimen, see IEC 60068-2-14.

NOTE For the damp heat test 25 °C is still used in some product standards.

Table F.7 – Clearances to withstand steady-state voltages, temporary overvoltages or recurring peak voltages

Table F.7a – Dimensioning of clearances to withstand steady-state voltages, temporary overvoltages or recurring peak voltages

Voltage ¹⁾ (peak value) ²⁾ kV	Minimum clearances in air up to 2 000 m above sea level	
	Case A Inhomogeneous field conditions (see 3.15) mm	Case B Homogeneous field conditions (see 3.15) mm
0,04	0,001 ³⁾	0,001 ³⁾
0,06	0,002 ³⁾	0,002 ³⁾
0,1	0,003 ³⁾	0,003 ³⁾
0,12	0,004 ³⁾	0,004 ³⁾
0,15	0,005 ³⁾	0,005 ³⁾
0,20	0,006 ³⁾	0,006 ³⁾
0,25	0,008 ³⁾	0,008 ³⁾
0,33	0,01	0,01
0,4	0,02	0,02
0,5	0,04	0,04
0,6	0,06	0,06
0,8	0,13	0,1
1,0	0,26	0,15
1,2	0,42	0,2
1,5	0,76	0,3
2,0	1,27	0,45
2,5	1,8	0,6
3,0	2,4	0,8
4,0	3,8	1,2
5,0	5,7	1,5
6,0	7,9	2
8,0	11,0	3
10	15,2	3,5
12	19	4,5
15	25	5,5
20	34	8
25	44	10
30	55	12,5
40	77	17
50	100	22
60		27
80		35
100		45

¹⁾ The clearances for other voltages are obtained by interpolation.
²⁾ See Figure 1 for recurring peak voltage.
³⁾ These values are based on experimental data obtained at atmospheric pressure.

Table F.7b – Additional information concerning the dimensioning of clearances to avoid partial discharge

Voltage ¹⁾ (peak value) ²⁾ kV	Minimum clearances in air up to 2 000 m above sea level
	Case A Inhomogeneous field conditions (see 3.15) mm
0,04	As specified for case A in Table F.7a
0,06	
0,1	
0,12	
0,15	
0,2	
0,25	
0,33	
0,4	
0,5	
0,6	
0,8	
1,0	
1,2	
1,5	
2,0	
2,5	2,0
3,0	3,2
4,0	11
5,0	24
6,0	64
8,0	184
10	290
12	320
15	3)
20	
25	
30	
40	
50	
60	
80	
100	

¹⁾ The clearances for other voltages are obtained by interpolation.
²⁾ See Figure 1 for recurring peak voltage.
³⁾ Dimensioning without partial discharge is not possible under inhomogeneous field conditions.

NOTE If clearances are stressed with steady-state voltages of 2,5 kV (peak) and above, dimensioning according to the breakdown values in Table F.7a may not provide operation without corona (partial discharges), especially for inhomogeneous fields. In order to provide corona-free operation, it is either necessary to use larger clearances, as given in Table F.7b, or to improve the field distribution.

Table F.8 – Altitude correction factors

Altitude m	Factor k_d for distance correction
0	0,784
200	0,803
500	0,833
1 000	0,844
2 000	1

<http://www.china-gauges.com/>

Bibliography

- [1] ISO/IEC Guide 2:1996, *Standardization and related activities – General vocabulary*

NOTE Harmonized as EN 45020:1998 (not modified).

- [2] IEC 60529:1989, *Degrees of protection provided by enclosures (IP Code)*
Amendment 1 (1999)

NOTE Harmonized as EN 60529:1991 + A1:2000 (not modified).

- [3] PFEIFFER, W. "Die Stoßspannungsfestigkeit von Luftstrecken kleiner Schlagweite".
Elektrotechnische Zeitschrift; Vol.28(1976), pp300-302

- [4] HERMSTEIN, W. "Bemessung von Luftstrecken, Insbesondere für 50 Hz-
Wechselspannung, Elektrotechnische Zeitschrift; Vol.90(1969), pp251-255

- [5] DAKIN, T., LUXA, G., OPPERMANN, G., VIGREUX, J., WIND, G. WINKELNKEMPER,
H. "Breakdown of gases in uniform fields, paschen curves for nitrogen, air and sulfur
hexafluoride"; Electra (issued by CIGRE), Vol.32(1974), pp61-82.

Annex ZA (normative)

Normative references to international publications with their corresponding European publications

The following referenced documents are indispensable for the application of this document. For dated references, only the edition cited applies. For undated references, the latest edition of the referenced document (including any amendments) applies.

NOTE When an international publication has been modified by common modifications, indicated by (mod), the relevant EN/HD applies.

<u>Publication</u>	<u>Year</u>	<u>Title</u>	<u>EN/HD</u>	<u>Year</u>
IEC 60038	1983	IEC standard voltages ¹⁾	HD 472 S1 + corr. February + A1	1989 2002 1995
IEC 60050-151	2001	International Electrotechnical Vocabulary (IEV) - Part 151: Electrical and magnetic devices	-	-
IEC 60050-212	1990	International Electrotechnical Vocabulary (IEV) - Chapter 212: Insulating solids, liquids and gases	-	-
IEC 60050-604 + A1	1987 1998	International Electrotechnical Vocabulary (IEV) - Chapter 604: Generation, transmission and distribution of electricity - Operation	-	-
IEC 60050-826	2004	International Electrotechnical Vocabulary (IEV) - Part 826: Electrical installations	-	-
IEC 60068-1	1988	Environmental testing - Part 1: General and guidance	EN 60068-1 ²⁾	1994
IEC 60068-2-2	1974	Environmental testing - Part 2: Tests - Tests B: Dry heat	EN 60068-2-2 ³⁾	1993
IEC 60068-2-14	1984	Environmental testing - Part 2: Tests - Test N: Change of temperature	EN 60068-2-14 ⁴⁾	1999
IEC 60068-2-78	2001	Environmental testing - Part 2-78: Tests - Test Cab: Damp heat, steady state	EN 60068-2-78	2001
IEC 60085	2004	Electrical insulation - Thermal classification	EN 60085	2004
IEC 60099-1	1991	Surge arresters - Part 1: Non-linear resistor type gapped surge arresters for a.c. systems	EN 60099-1	1994

¹⁾ The title of HD 472 S1 is: Nominal voltages for low voltage public electricity supply systems.

²⁾ EN 60068-1 includes A1:1992 to IEC 60068-1 + corr. October.

³⁾ EN 60068-2-2 includes supplement A to IEC 60068-2-2.

⁴⁾ EN 60068-2-14 includes A1:1986 to IEC 60068-2-14.

<u>Publication</u>	<u>Year</u>	<u>Title</u>	<u>EN/HD</u>	<u>Year</u>
IEC 60112	2003	Method for the determination of the proof and the comparative tracking indices of solid insulating materials	EN 60112	2003
IEC 60216	Series	Electrical insulating materials - Properties of thermal endurance	EN 60216	Series
IEC 60243-1	1998	Electrical strength of insulating materials - Test methods - Part 1: Tests at power frequencies	EN 60243-1	1998
IEC 60270	2000	High-voltage test techniques - Partial discharge measurements	EN 60270	2001
IEC 60364-4-44 + A1 (mod)	2001 2003	Electrical installations of buildings - Part 4-44: Protection for safety - Protection against voltage disturbances and electromagnetic disturbances	-	-
IEC 60664-4	2005	Insulation coordination for equipment within low-voltage systems - Part 4: Consideration of high-frequency voltage stress	EN 60664-4 + corr. October	2006 2006
IEC 60664-5	- ⁵⁾	Insulation coordination for equipment within low-voltage systems - Part 5: A comprehensive method for determining clearances and creepage distances equal to or less than 2 mm	EN 60664-5	2003 ⁶⁾
IEC 61140 A1 (mod)	2001 2004	Protection against electric shock - Common aspects for installation and equipment	EN 61140 A1	2002 2006
IEC 61180-1	1992	High-voltage test techniques for low-voltage equipment - Part 1: Definitions, test and procedure requirements	EN 61180-1	1994
IEC 61180-2	1994	High-voltage test techniques for low-voltage equipment - Part 2: Test equipment	EN 61180-2	1994
IEC Guide 104	1997	The preparation of safety publications and the use of basic safety publications and group safety publications	-	-

⁵⁾ Undated reference.

⁶⁾ Valid edition at date of issue.

<http://www.china-gauges.com/>

BSI — British Standards Institution

BSI is the independent national body responsible for preparing British Standards. It presents the UK view on standards in Europe and at the international level. It is incorporated by Royal Charter.

Revisions

British Standards are updated by amendment or revision. Users of British Standards should make sure that they possess the latest amendments or editions.

It is the constant aim of BSI to improve the quality of our products and services. We would be grateful if anyone finding an inaccuracy or ambiguity while using this British Standard would inform the Secretary of the technical committee responsible, the identity of which can be found on the inside front cover. Tel: +44 (0)20 8996 9000. Fax: +44 (0)20 8996 7400.

BSI offers members an individual updating service called PLUS which ensures that subscribers automatically receive the latest editions of standards.

Buying standards

Orders for all BSI, international and foreign standards publications should be addressed to Customer Services. Tel: +44 (0)20 8996 9001. Fax: +44 (0)20 8996 7001. Email: orders@bsi-global.com. Standards are also available from the BSI website at <http://www.bsi-global.com>.

In response to orders for international standards, it is BSI policy to supply the BSI implementation of those that have been published as British Standards, unless otherwise requested.

Information on standards

BSI provides a wide range of information on national, European and international standards through its Library and its Technical Help to Exporters Service. Various BSI electronic information services are also available which give details on all its products and services. Contact the Information Centre. Tel: +44 (0)20 8996 7111. Fax: +44 (0)20 8996 7048. Email: info@bsi-global.com.

Subscribing members of BSI are kept up to date with standards developments and receive substantial discounts on the purchase price of standards. For details of these and other benefits contact Membership Administration. Tel: +44 (0)20 8996 7002. Fax: +44 (0)20 8996 7001. Email: membership@bsi-global.com.

Information regarding online access to British Standards via British Standards Online can be found at <http://www.bsi-global.com/bsonline>.

Further information about BSI is available on the BSI website at <http://www.bsi-global.com>.

Copyright

Copyright subsists in all BSI publications. BSI also holds the copyright, in the UK, of the publications of the international standardization bodies. Except as permitted under the Copyright, Designs and Patents Act 1988 no extract may be reproduced, stored in a retrieval system or transmitted in any form or by any means – electronic, photocopying, recording or otherwise – without prior written permission from BSI.

This does not preclude the free use, in the course of implementing the standard, of necessary details such as symbols, and size, type or grade designations. If these details are to be used for any other purpose than implementation then the prior written permission of BSI must be obtained.

Details and advice can be obtained from the Copyright & Licensing Manager. Tel: +44 (0)20 8996 7070. Fax: +44 (0)20 8996 7553. Email: copyright@bsi-global.com.

BSI
389 Chiswick High Road
London
W4 4AL