

Solderless connections —

Part 2: Crimped connections — General
requirements, test methods and
practical guidance

<http://www.china-gauges.com/>

ICS 31.220.10

National foreword

This British Standard is the UK implementation of EN 60352-2:2006+A1:2013. It is identical to IEC 60352-2:2006 incorporating amendment 1:2013. It supersedes BS EN 60352-2:2006, which is withdrawn.

The start and finish of text introduced or altered by amendment is indicated in the text by tags. Tags indicating changes to IEC text carry the number of the IEC amendment. For example, text altered by IEC amendment 1 is indicated by A1 A1 .

The UK participation in its preparation was entrusted to Technical Committee EPL/48, Electromechanical components and mechanical structures for electronic equipment.

A list of organizations represented on this committee can be obtained on request to its secretary.

The publication does not purport to include all the necessary provisions of a contract. Users are responsible for its correct application.

Compliance with a British Standard cannot confer immunity from legal obligations.

This British Standard was published under the authority of the Standards Policy and Strategy Committee on 31 July 2006

© The British Standards Institution 2013.
Published by BSI Standards Limited 2013

Amendments/corrigenda issued since publication

| Date | Comments |
|-------------------|---|
| 30 September 2013 | Implementation of IEC amendment 1:2013 with CENELEC endorsement A1:2013 |
| | |
| | |
| | |

**Solderless connections
Part 2: Crimped connections -
General requirements,
test methods and practical guidance
(IEC 60352-2:2006)**

Connexions sans soudure
Partie 2: Connexions serties -
Exigences générales,
méthodes d'essai et guide pratique
(CEI 60352-2:2006)

Lötfreie Verbindungen
Teil 2: Crimpverbindungen -
Allgemeine Anforderungen,
Prüfverfahren und Anwendungshinweise
(IEC 60352-2:2006)

This European Standard was approved by CENELEC on 2006-03-01. CENELEC members are bound to comply with the CEN/CENELEC Internal Regulations which stipulate the conditions for giving this European Standard the status of a national standard without any alteration.

Up-to-date lists and bibliographical references concerning such national standards may be obtained on application to the Central Secretariat or to any CENELEC member.

This European Standard exists in three official versions (English, French, German). A version in any other language made by translation under the responsibility of a CENELEC member into its own language and notified to the Central Secretariat has the same status as the official versions.

CENELEC members are the national electrotechnical committees of Austria, Belgium, Cyprus, the Czech Republic, Denmark, Estonia, Finland, France, Germany, Greece, Hungary, Iceland, Ireland, Italy, Latvia, Lithuania, Luxembourg, Malta, the Netherlands, Norway, Poland, Portugal, Romania, Slovakia, Slovenia, Spain, Sweden, Switzerland and the United Kingdom.

CENELEC

European Committee for Electrotechnical Standardization
Comité Européen de Normalisation Electrotechnique
Europäisches Komitee für Elektrotechnische Normung

Central Secretariat: rue de Stassart 35, B - 1050 Brussels

Foreword

The text of document 48B/1584/FDIS, future edition 2 of IEC 60352-2, prepared by SC 48B, Connectors of IEC TC 48, Electromechanical components and mechanical structures for electronic equipment, was submitted to the IEC-CENELEC parallel vote and was approved by CENELEC as EN 60352-2 on 2006-03-01.

This European Standard supersedes EN 60352-2:1994 + A1:1997 + A2:2002.

It includes the following major technical changes with respect to EN 60352-2:1994 and its amendments:

- a) the contents of clauses have been re-arranged, for example the old Clauses 5, 6, 7, 8 and 9 are now included in the new Clause 4, Requirements;
- b) Subclause 4.3.1, the material requirements for crimp barrels have been changed from Vickers hardness into more appropriate tensile strength requirements and the requirements have been opened to other materials, in terms of suitable characteristics;
- c) Subclause 4.3.3, Surface finishes: the tin-lead has been replaced by tin-alloy to comply with RoHS legislation. Other plating materials, such as nickel, may be used provided their suitability has been proven;
- d) Subclause 5.1.4, Recovering, has been added;
- e) Table 2, example of other materials, has been shortened;
- f) Subclause 5.2.4.5 and Figure 7, Current loading, cyclic: the length of wire between two specimens has been changed to a "minimum of 150 mm" to comply with regional requirements;
- g) Subclause 5.2.4.6, Crimping at low temperature, has been changed to "under consideration";
- h) Subclause 15.4 of amendment A1 has been deleted for the sake of design freedom, because the dimensions are not widely used as stated; only a minority of products, in most cases older ones have these dimensions.

The following dates were fixed:

- | | | |
|--|-------|------------|
| – latest date by which the EN has to be implemented at national level by publication of an identical national standard or by endorsement | (dop) | 2006-12-01 |
| – latest date by which the national standards conflicting with the EN have to be withdrawn | (dow) | 2009-03-01 |

Annex ZA has been added by CENELEC.

Endorsement notice

The text of the International Standard IEC 60352-2:2006 was approved by CENELEC as a European Standard without any modification.

Foreword to amendment A1

The text of document 48B/2340/FDIS, future IEC 60352-2:2006/A1, prepared by SC 48B, "Connectors", of IEC TC 48, "Electromechanical components and mechanical structures for electronic equipment" was submitted to the IEC-CENELEC parallel vote and approved by CENELEC as EN 60352-2:2006/A1:2013.

The following dates are fixed:

- latest date by which the document has (dop) 2014-05-01 to be implemented at national level by publication of an identical national standard or by endorsement
- latest date by which the national (dow) 2016-08-01 standards conflicting with the document have to be withdrawn

Attention is drawn to the possibility that some of the elements of this document may be the subject of patent rights. CENELEC [and/or CEN] shall not be held responsible for identifying any or all such patent rights.

Endorsement notice

The text of the International Standard IEC 60352-2:2006/A1:2013 was approved by CENELEC as a European Standard without any modification.

CONTENTS

| | |
|--|----|
| INTRODUCTION..... | |
| 1 Scope and object..... | 8 |
| 2 Normative references..... | 8 |
| 3 Terms and definitions..... | 9 |
| 4 Requirements..... | 11 |
| 4.1 Workmanship..... | 11 |
| 4.2 Tools..... | 11 |
| 4.3 Crimp barrels..... | 11 |
| 4.4 Wires..... | 12 |
| 4.5 Crimped connections..... | 12 |
| 5 Tests..... | 13 |
| 5.1 Testing..... | 13 |
| 5.2 Test methods and test requirements..... | 14 |
| 5.3 Test schedules..... | 21 |
| 6 General information on crimp connections..... | 32 |
| 6.1 General..... | 32 |
| 6.2 Advantages of crimped connections..... | 32 |
| 6.3 Current-carrying capacity considerations..... | 32 |
| 7 Tool information..... | 33 |
| 8 Crimp barrel information..... | 33 |
| 8.1 General..... | 33 |
| 8.2 Materials..... | 35 |
| 8.3 Surface finishes..... | 35 |
| 8.4 Shapes of crimped connections..... | 35 |
| 9 Wire information..... | 38 |
| 9.1 General..... | 38 |
| 9.2 Materials..... | 38 |
| 9.3 Surface finishes..... | 39 |
| 9.4 Stripping information..... | 39 |
| 10 Connection information..... | 42 |
| 10.1 General..... | 42 |
| 10.2 Crimped connections made with more than one wire in a crimp barrel..... | 46 |
| 10.3 Dimensions after crimping..... | 46 |
| 10.4 Materials..... | 46 |
| 11 Crimping process..... | 46 |
| 11.1 Crimping of contacts with open crimp barrel..... | 46 |
| 11.2 Crimping of contacts with open crimp barrel, loose piece contacts..... | 46 |
| 11.3 Processing instruction..... | 47 |
| 12 Correct crimped connections (additional information)..... | 48 |
| 12.1 Correct crimped connections of contacts with an open crimp barrel..... | 48 |
| 12.2 Measuring of crimp height/depth..... | 48 |
| 12.3 Insulation grip..... | 50 |

<http://www.china-gauges.com/>

| | | |
|---|--|----|
| 13 | Faults with crimped contacts having open barrels..... | 51 |
| 14 | General information about crimp type contacts as part of a multipole connector | 54 |
| 14.1 | Insertion of crimped contacts into the contact cavities of the connector housing | 54 |
| 14.2 | Removal of inserted contacts..... | 54 |
| 14.3 | Mounting and bending of wire bundles/cables with crimped contacts..... | 54 |
| 14.4 | Mating and unmating of multipole connectors with crimped contacts..... | 55 |
| 15 | Final remarks | 56 |
| Annex ZA (normative) Normative references to international publications with their corresponding European publications..... | | 57 |
| Figure 1 – Open crimp barrel | | 9 |
| Figure 2 – Closed crimp barrel | | 9 |
| Figure 3 – Pre-insulated crimp barrel | | 10 |
| Figure 4 – Crimping zones..... | | 10 |
| Figure 5 – Test arrangement for measurement of contact resistance | | 15 |
| Figure 6 – Contact resistance R_C of crimped connections with copper barrels and copper conductor ($K = 1$) | | 16 |
| Figure 7 – Examples of test arrangements..... | | 19 |
| Figure 8 – Test current for crimped connections..... | | 20 |
| Figure 9 – Examples of type A specimens | | 22 |
| Figure 10 – Examples of type B specimens | | 22 |
| Figure 11 – Example of type C specimen..... | | 23 |
| Figure 12 – Examples of type D specimens | | 23 |
| Figure 13 – Example of type E specimen..... | | 24 |
| Figure 14 – Basic test schedule (see 5.3.2) | | 30 |
| Figure 15 – Full test schedule (see 5.3.3)..... | | 31 |
| Figure 16 – Open crimp barrels | | 34 |
| Figure 17 – Closed crimp barrels..... | | 35 |
| Figure 18 – Crimping shape in the wire axis | | 36 |
| Figure 19 – Crimping shape 90° angled to the wire axis..... | | 36 |
| Figure 20 – Crimping shape without insulation grip..... | | 37 |
| Figure 21 – Crimping shape with pre-insulation crimp barrel..... | | 37 |
| Figure 22 – Crimping shape without pre-insulation crimp barrel | | 38 |
| Figure 23 – Stripping length..... | | 39 |
| Figure 24 – Correctly stripped wire | | 40 |
| Figure 25 – Examples of stripping faults..... | | 41 |
| Figure 26 – Examples of correctly crimped connections with open crimp barrels..... | | 42 |
| Figure 27 – Examples of correctly crimped connections with closed crimp barrels | | 43 |
| Figure 28 – Examples of crimping faults with open crimp barrels, with insulation grip..... | | 44 |
| Figure 29 – Examples of crimping faults with closed crimp barrels, without insulation grip | | 45 |
| Figure 30 – Crimping process of an open crimp barrel | | 47 |
| Figure 31 – Correct crimped connections of contacts with open crimp barrel..... | | 48 |

| | |
|---|----|
| Figure 32 – Measuring instructions | 49 |
| Figure 33 – Measuring process | 49 |
| Figure 34 – Examples of insulation grips | 50 |
| Figure 35 – Examples of faults with crimped contacts | 53 |
| Figure 36 – Insertion of crimped contacts into contact cavities..... | 54 |
| Figure 37 – Mounting of wire bundles/cables with crimped contacts | 55 |
| Figure 38 – Bending of wire bundles of connectors..... | 55 |
| Figure 39 – Mating and unmating of multipole connectors..... | 56 |
| | |
| Table 1 – Pull out force of crimped connections | 14 |
| Table 2 – Example of other materials | 17 |
| Table 3 – Number of specimens | 24 |
| Table 4 – Test group P1 | 25 |
| Table 5 – Test group P2 | 25 |
| Table 6 – Test group P3 | 26 |
| Table 7 – Test group P4 | 26 |
| Table 8 – Test group A | 27 |
| Table 9 – Test group B | 27 |
| Table 10 – Test group C | 28 |
| Table 11 – Test group D | 28 |
| Table 12 – Test group E | 29 |
| Table 13 – Test group F | 29 |
| Table 14 – Test group G | 29 |

INTRODUCTION

IEC 60352-2 includes requirements, tests and practical guidance information. Two test schedules are provided: a basic test schedule which applies to solderless crimped connections which conform to all of the requirements given in Clause 4 and a full test schedule which applies to solderless crimped connections which do not fully conform to all of the requirements, for example which are made with solid wires, different materials, etc.

IEC Guide 109 advocates the need to minimise the impact of a product on the natural environment throughout the product life cycle. It is understood that some of the materials permitted in this standard may have a negative environmental impact. As technological advances lead to acceptable alternatives for these materials, they will be eliminated from the standard.

<http://www.china-gauges.com/>

SOLDERLESS CONNECTIONS –

Part 2: Crimped connections – General requirements, test methods and practical guidance

1 Scope and object

This part of IEC 60352 is applicable to solderless crimped connections made with stranded wires of 0,05 mm² to 10 mm² cross-section and solid wires of 0,25 mm to 3,6 mm diameter and appropriately designed uninsulated or pre-insulated crimp barrels for use in telecommunication equipment and in electronic devices employing similar techniques.

Information on the materials and data from industrial experience is included in addition to the test procedures to provide electrically stable connections under prescribed environmental conditions.

NOTE This part of IEC 60352 is not intended to be applicable to crimping of coaxial cables.

The object of this part of IEC 60352 is to determine the suitability of solderless crimped connections under specified mechanical, electrical and atmospheric conditions and to provide a means of comparing test results when the tools used to make the connections are of different designs or manufacture.

2 Normative references

The following referenced documents are indispensable for the application of this document. For dated references, only the edition cited applies. For undated references, the latest edition of the referenced document (including any amendments) applies.

IEC 60050(581):1978, *International Electrotechnical Vocabulary (IEV) – Chapter 581: Electro-mechanical components for electronic equipment*

IEC 60068-1:1988, *Environmental testing – Part 1: General and guidance*
Amendment 1 (1992)

IEC 60189-3:1988, *Low-frequency cables and wires with PVC insulation and PVC sheath – Part 3: Equipment wires with solid or stranded conductor, PVC insulated, in singles, pairs and triples*

IEC 60512 (all parts), *Connectors for electronic equipment – Tests and measurements*

IEC 60512-1-100:2001, *Connectors for electronic equipment – Tests and measurements – Part 1-100: General – Applicable publications*

IEC 60760:1989, *Flat, quick-connect terminations*
Amendment 1 (1993)

ISO 6892:1998, *Metallic materials – Tensile testing at ambient temperature*

3 Terms and definitions

For the purpose of this document, the terms and definitions of IEC 60050(581), IEC 60512-1 and the following apply:

3.1 crimp barrel

conductor barrel designed to accommodate one or more conductors and to be crimped by means of a crimping tool

3.2 open crimp barrel

crimp barrel with an open shape before crimping, for example U- or V-shape (see Figure 1)

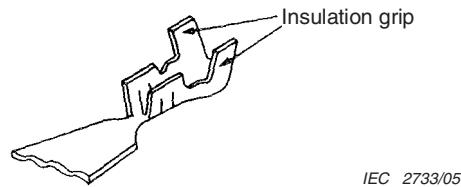

Figure 1 – Open crimp barrel

3.3 closed crimp barrel

crimp barrel with a closed shape before crimping (see Figure 2)

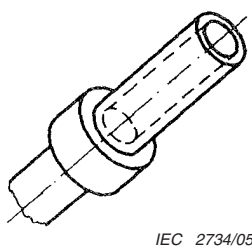

Figure 2a – Machined crimp barrel

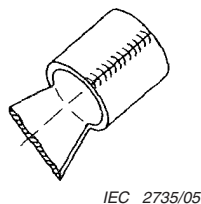

Figure 2b – Brazed/welded crimp barrel

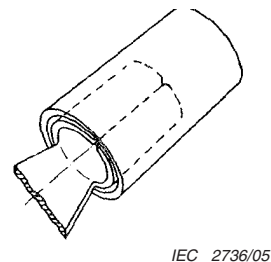

Figure 2c – Stamped/rolled crimp barrel

Figure 2 – Closed crimp barrels

3.4 pre-insulated crimp barrel

crimp barrel with a permanent layer of insulation through which the crimp is made (see Figure 3)

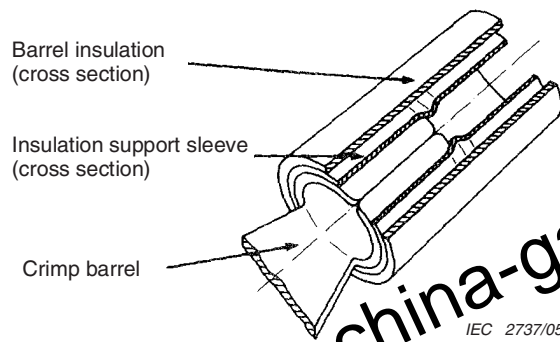

Figure 3 – Pre-insulated crimp barrel

3.5 crimping zone

that portion of a crimp barrel where the crimped connection is achieved by pressure deformation or reshaping of the barrel around the conductor (see Figure 4)

NOTE Where the crimp barrel is equipped with an insulation grip, this is also reshaped by compression by the crimping tool to secure the insulation of the wire.

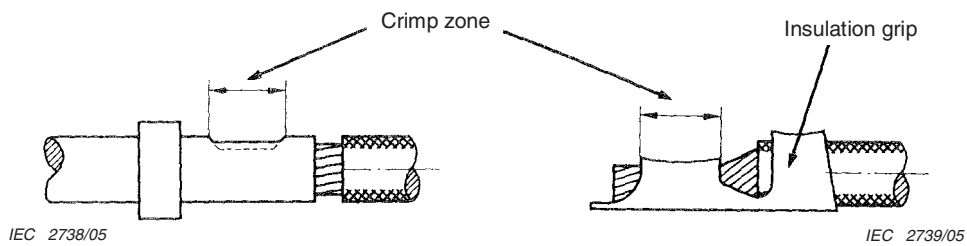

Figure 4a – Closed crimp barrel

Figure 4b – Open crimp barrel

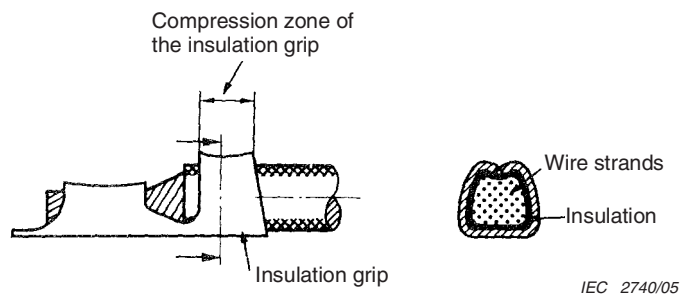

Figure 4c – Insulation grip

Figure 4 – Crimping zones

3.6 crimping die

that part of a crimping tool which forms the crimp(s) and usually incorporates the crimp anvil(s), the crimp indenter(s), and the positioner

NOTE Crimping dies may have separate or integral sections for compressing the insulation grip, if provided.

4 Requirements

4.1 Workmanship

The connection shall be processed in a careful and workmanlike manner, in accordance with good current practice.

4.2 Tools

Crimping tools shall be used and inspected according to the instructions given by the tool manufacturer.

The crimping tool shall be able to make uniformly reliable connections during its useful life.

The crimping tool shall be equipped with the appropriate dies. Where the dies are adjustable, the correct setting for the barrel to be crimped shall be used.

Hand crimping tools shall be provided with a full cycle crimping mechanism.

Automatic crimping tools shall be provided with a full cycle crimping mechanism or equivalent safeguard. They shall be correctly set and the setting shall be maintained.

Tools are evaluated by testing crimped connections made with the tools to be evaluated.

4.3 Crimp barrels

4.3.1 Materials

Crimp barrels shall be made of copper or copper alloy with a copper content of 60 % minimum.

The minimum tensile strength of the material shall not exceed 600 MPa in accordance with ISO 6892.

Other materials of suitable characteristics may be used, for example nickel, steel, stainless steel. Materials with a high resistivity-coefficient (K values, see 5.2.3.1) or materials exceeding the tensile strength specified above, may not be suitable for certain applications. In these cases, the full test schedule of 5.3.3 shall be applied (see 5.1.1).

4.3.2 Dimensions

The dimensions shall be suitable for stranded wires as specified in 4.4.

4.3.3 Surface finishes

The crimp barrel shall be unplated or plated with tin, tin-alloy, silver, gold or palladium.

The surface shall be free of contamination and corrosion. Other plating materials, such as nickel, (unless used as under-plate) may be used provided their suitability has been proven. In these cases, the full test schedule of 5.3.3 shall be applied (see 5.1.1).

4.3.4 Design features

The crimp barrel shall be so designed that the crimped connection is achieved by pressure deformation or reshaping of the crimp barrel around the stripped conductor.

NOTE Techniques where the connection is achieved by parts of barrel penetrating through the insulation of an insulated conductor are not covered by this standard.

The following barrel types shall be used:

- open crimp barrels, uninsulated;
- closed crimp barrel, either pre-insulated or uninsulated.

The crimp barrels shall be free of sharp edges likely to damage the conductors.

4.4 Wires

4.4.1 General

Stranded conductors shall be used, solid round conductors of 0,25 mm to 3,6 mm diameter may be used provided their suitability has been proven.

4.4.2 Materials

Annealed copper having an elongation at break of not less than 10 % shall be used.

4.4.3 Dimensions

The cross-section of the stranded conductor shall be within the range 0,05 mm² to 10 mm².

4.4.4 Surface finishes

Conductors which are unplated or finished with tin, tin-alloy or silver shall be used.

The surface shall be free of contamination and corrosion.

4.4.5 Insulation

The insulation shall be capable of being readily stripped from the conductor without changing the physical characteristics of the conductor or strands, respectively.

4.5 Crimped connections

The combination of the tool, barrel and wire shall be compatible.

Where the crimp barrel is equipped with an insulation support or insulation grip, the overall diameter of the insulation wire shall be compatible with the dimensions of the support or grip.

The wire shall be stripped to the correct length. The strands of the stripped part of the conductor shall not be damaged, for example partly or totally broken.

The stripped part of the conductor shall be clean and free from particles of insulation.

The lay of the strands shall be correct. If the lay has been disturbed, it may be restored by a light twist.

The conductor shall be correctly located in the barrel, i.e. to the correct depth. This shall be verified as follows:

- in the case of open crimp barrels or closed crimp barrels with inspection provision, this shall be visually checked;
- in the case of closed crimp barrels without inspection provisions, for example an inspection hole, this shall be measured (indirectly by measuring the possible insertion depth of the barrel, the stripping length of the wire and the distance between the end of the barrel and the beginning of the wire insulation).

All strands of the wire shall be within the barrel. There shall be no damaged strands.

Where the crimp barrel is equipped with an insulation support or insulation grip, the insulation shall be correctly located in the support or grip.

NOTE For crimped connections made with more than one wire, see 10.2.

5 Tests

5.1 Testing

5.1.1 General

As explained in the introduction, there are two test schedules which shall be applied according to the following conditions:

- crimped connections, which conform to all of the requirements of Clause 4 shall be tested to and meet the requirements of the basic test schedule of 5.3.2;
- crimped connections, which do not fully conform to all of the requirements of Clause 4, for example which are made with solid wires, different materials, etc., shall be tested to and meet the requirements of the full test schedule of 5.3.3.

NOTE For crimped connections made with more than one wire, see 10.2.

5.1.2 Standard conditions for testing

Unless otherwise specified, all tests shall be carried out under the standard conditions for testing as specified in IEC 60512-1.

The ambient temperature and the relative humidity at which the measurements are made shall be stated in the test report.

In case of dispute about test results, the test shall be repeated at one of the referred conditions of IEC 60068-1.

5.1.3 Preconditioning

Where specified, the connection shall be preconditioned under standard conditions for testing for a period of 24 h, in accordance with IEC 60512-1.

5.1.4 Recovering

Where specified, the specimen shall be allowed to recover under standard conditions for testing for a period of 1 h to 2 h, after conditioning.

5.1.5 Mounting of the specimen

When mounting is required in a test, the specimens shall be mounted using the normal mounting method, unless otherwise specified.

5.2 Test methods and test requirements

5.2.1 General examination

The tests shall be carried out in accordance with test 1a of IEC 60512 and test 11 of IEC 60512. The visual examination test may be carried out with magnification up to approximately five times.

All crimp connections shall be examined to ensure that the applicable requirements of 4.3 to 4.5 have been met.

5.2.2 Mechanical tests

5.2.2.1 Pull out force

The test shall be carried out in accordance with test 16d of IEC 60512.

Unless otherwise specified by the manufacturer of the crimp barrel (terminal), the minimum values of the pull out force given in Table 1 shall be applied.

Table 1 – Pull out force of crimped connections

| Conductor cross-section | | Pull out force |
|-------------------------|------------------|----------------|
| mm ² | AWG ^a | N |
| 0,05 | 30 | 6 |
| 0,08 | 28 | 11 |
| 0,12 | 26 | 15 |
| 0,14 | | 18 |
| 0,22 | 24 | 28 |
| 0,25 | | 32 |
| 0,32 | 22 | 40 |
| 0,5 | 20 | 60 |
| 0,75 | | 85 |
| 0,82 | 18 | 90 |
| 1,0 | | 108 |
| 1,3 | 16 | 135 |
| 1,5 | | 150 |
| 2,1 | 14 | 200 |
| 2,5 | | 230 |
| 3,3 | 12 | 275 |
| 4,0 | | 310 |
| 5,3 | 10 | 355 |
| 6,0 | | 360 |
| 8,4 | 8 | 370 |
| 10,0 | | 380 |

NOTE To test the crimped connection, the same values are included in IEC 60760, Clause 17 and IEC 61210, Table 9.

^a For information only.

5.2.2.2 Insulation grip effectiveness

The test shall be carried out in accordance with test 16h of IEC 60512.

Number of winding cycles: 2

Tension to be applied: Lowest tension necessary to bring the wire into contact with the mandrel.

5.2.3 Electrical tests

5.2.3.1 Contact resistance

The test shall be carried out in accordance with test 2a of IEC 60512 or with test 2b of IEC 60512, as specified in the detail specification.

A suitable test arrangement is shown in Figure 5.

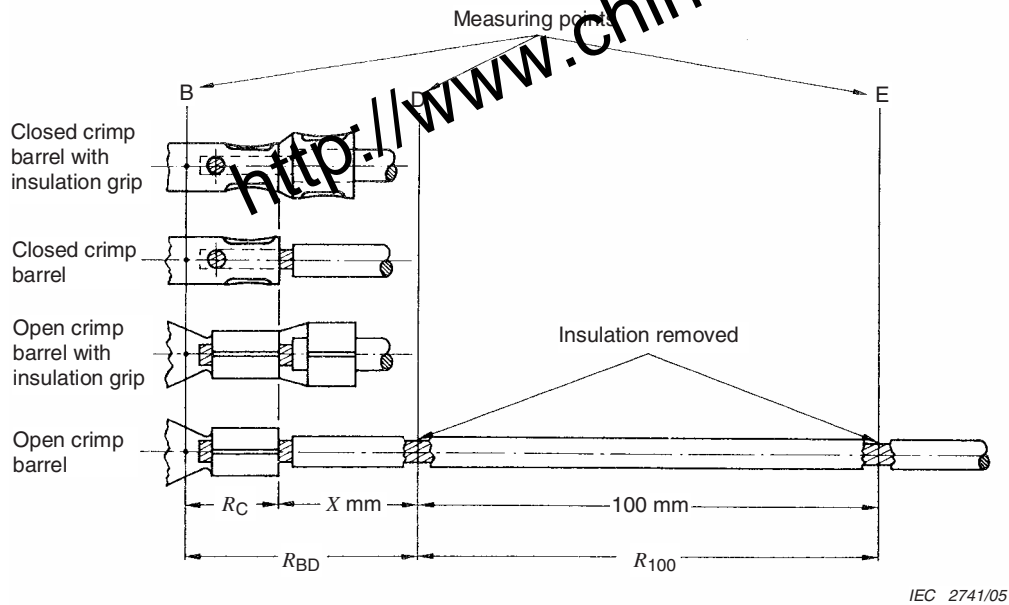

$$R_C = R_{BD} - \frac{X}{100} \times R_{100}$$

where

R_C is the contact resistance of crimped connection;

R_{BD} is the measured resistance between measuring points B and D;

R_{100} is the measured distance over 100 mm wire length (D – E);

X is the distance between crimp barrel and measuring point D in mm.

NOTE For distance X , 25 mm to 100 mm is recommended.

Figure 5 – Test arrangement for measurement of contact resistance

Contact point B shall be as close as possible to the end of the wire in the crimp barrel but, in the case of an open crimp barrel, not touching the end of the wire.

To achieve dependable and reproducible test results, good contact to all strands at the measuring points is necessary. By locating the measuring point D at a safe distance away from the crimped connection, any means to ensure the necessary good contact to all strands may be used.

A suitable test device shall be used to ensure good contact at all measuring points. The test device shall ensure that the measuring points are located at predetermined fixed distances. Where test probes are used, they shall be sufficiently rounded to avoid damaging the conductor strands.

When test 2b of IEC 60512 is applied, the test current shall be 1 A per mm² conductor cross-section. The duration of application of the test current shall be short enough to prevent heating of the specimens.

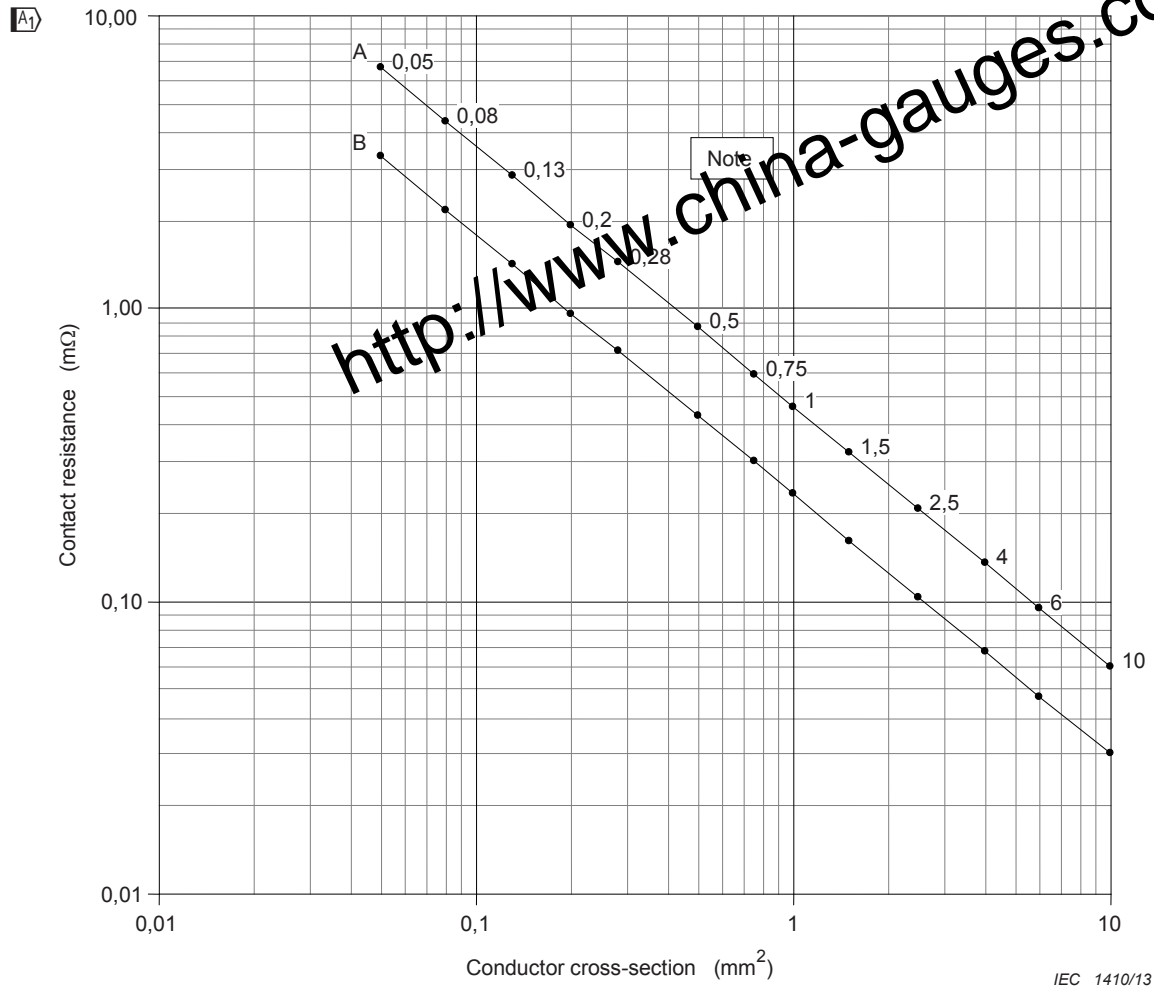

Curve A: Values for initial contact resistance, maximum.

Curve B: Values for maximum change in resistance after electrical or climatic conditioning.

NOTE Numbers indicate specific conductor cross-sections in mm².

The lines for maximum initial contact resistance (A) and maximum change in resistance after electrical or climatic conditioning (B) are based on the following equations. These formulas may be used in place of the graph in Figure 6 to determine the maximum allowed initial resistance and post-conditioning change in resistance values.

$$A = 0,4596xC^{-0,8843}$$

$$B = A / 2$$

Where:

A is the maximum allowed initial resistance, in milliohms (mΩ);

B is the maximum allowed change in resistance, in milliohms (mΩ);

C is the wire cross-section, in mm².

Figure 6 – Contact resistance R_C of crimped connections with copper barrels and copper conductor ($K = 1$) $\square A_1$

The cross-section to be used when applying Figure 6 is the cross-section calculated with the number of strands and the nominal diameter of one strand.

The values for maximum initial contact resistance (curve A) and the values for maximum change in resistance (curve B) as presented in Figure 6 apply only to crimped connections made with crimp barrels according to 4.3 and conductors according to 4.4 and where $K = 1$.

For barrel materials other than copper, the values of both curves A and B are to be multiplied by “ K ”, where

$$K = \frac{\text{resistivity of material used}}{\text{resistivity of copper}}$$

Table 2 includes values of resistivity and K for other materials.

Table 2 Example of other materials

| Material | Resistivity $\Omega \text{ mm}^2/\text{m}$ | K |
|------------------------------|---|--------------|
| Annealed copper, 100,0 Cu | 0,017 2 | 1 |
| Copper-zinc alloys (brasses) | 0,030 to 0,061 | 1,74 to 3,55 |
| For example 70,0 Cu, 30,0 Zn | 0,061 | 3,55 |
| Copper-tin alloys (bronzes) | 0,083 to 0,15 | 4,83 to 8,72 |
| For example 94,0 Cu, 6,0 Sn | 0,11 | 6,40 |

The maximum permitted change in resistance is to be added to the initially measured resistance, not to the permitted initial limit, i.e. the maximum permitted contact resistance after conditioning is equal to the measured initial value plus the maximum permitted change as given in curve B of Figure 6 and corrected by “ K ”, if applicable.

NOTE For crimped connections made with more than one wire, see 10.2. For further information on wires, see IEC 60189-3.

5.2.3.2 Voltage proof (crimped connection with pre-insulated crimp barrels)

The test shall be carried out in accordance with test 4c of IEC 60512.

Proof voltage: 1 500 V r.m.s. 45 Hz to 60 Hz unless otherwise agreed between user and manufacturer.

5.2.4 Climatic tests

5.2.4.1 General

Unless otherwise specified, the following upper category temperature (UCT) and lower category temperature (LCT) shall be used in the following tests:

UCT : +125 °C (for tin plated barrels +100 °C)

LCT : -55 °C

5.2.4.2 Rapid change of temperature

The test shall be carried out in accordance with test 11d of IEC 60512.

The following details shall apply:

| | | |
|-----------------------|-------|--------|
| Low temperature: | T_A | LCT |
| High temperature | T_B | UCT |
| Duration of exposure: | t_1 | 30 min |
| Number of cycles: | | 5 |

This test is not intended to examine the characteristics of the wire insulation nor the insulation of pre-insulated crimp barrels.

5.2.4.3 Dry heat

The test shall be carried out in accordance with test 11i of IEC 60512.

The following details shall apply:

Test temperature: *UCT*
Test duration: 96 h

This test is not intended to examine the characteristics of the wire insulation.

5.2.4.4 Climatic sequence

The test shall be carried out in accordance with test 11a of IEC 60512.

The following details shall apply:

- Dry heat
test temperature: *UCT*
- Damp heat, cyclic:
upper test temperature: +55 °C
number of cycles: 6
variant 1 or 2 to be specified
- Cold:
test temperature: *LCT*

This test is not intended to examine the characteristics of the wire insulation nor the insulation of pre-insulated crimp barrels.

5.2.4.5 Current loading, cyclic

The test shall be carried out in accordance with test 9e of IEC 60512.

The test shall be carried out using type D specimens (see 5.3.1.5).

Unless otherwise specified by the detail specification, the specimens may be connected in series so that the current loading is simultaneously applied to all specimens under test. If connecting in series is applied and if the design permits, double-ended specimens may be used. In this case, the length of wire between two specimens shall be a minimum of 150 mm. To avoid heat sink, the chain of the specimens shall be held at the wires and the holding devices should be made of insulating material with low thermal conductivity. Where the mass of the terminations is so big that additional support is necessary, the holding devices shall also be made of insulating material with low thermal conductivity.

NOTE Where the crimped connection to be tested forms an integral part of a component, care should be taken to avoid an influence of the component on the test result (for example heat sink).

Examples are given in Figure 7 and in IEC 60760.

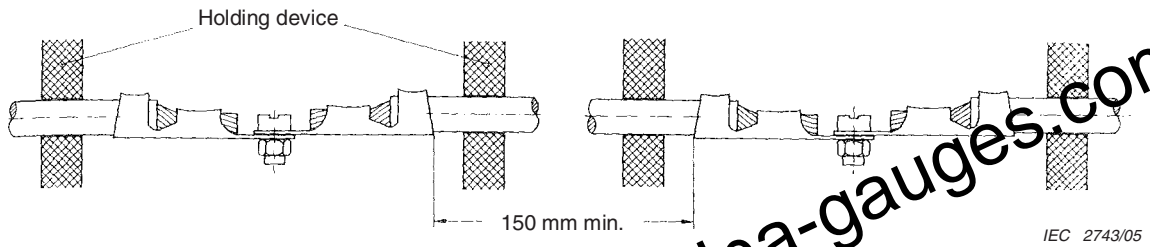

Figure 7a – Example of crimped barrels with terminal ends

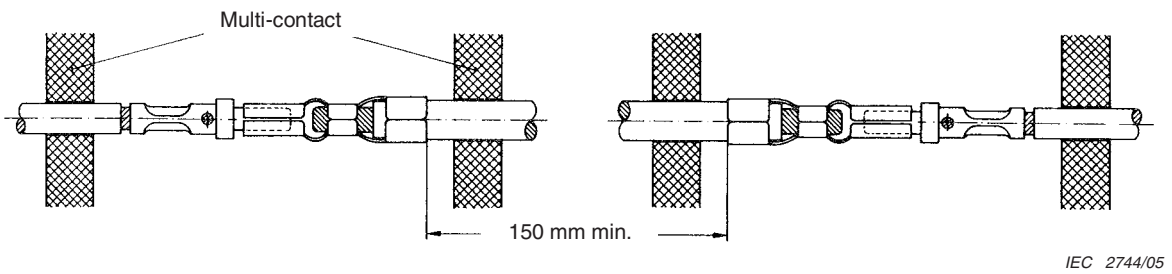

Figure 7b – Example of crimp barrels with separable contacts

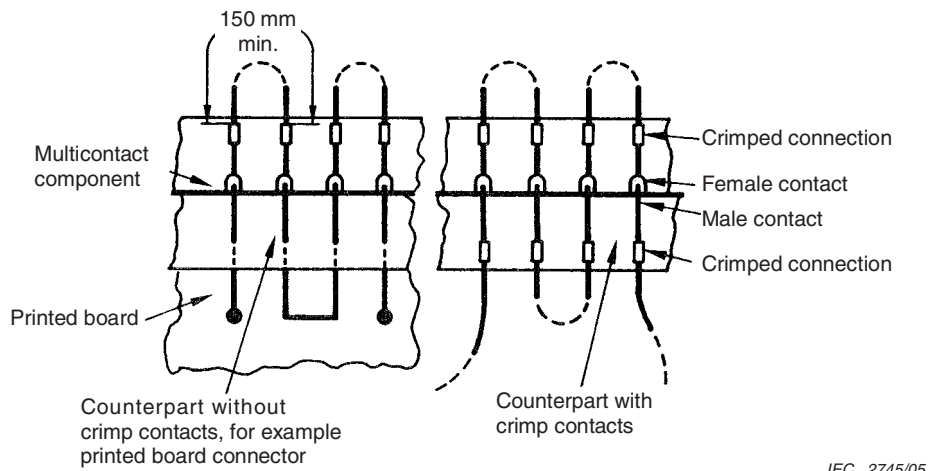

Figure 7c – Example of crimp connection with contacts of a multi-contact component (for example terminal block or connector)

Figure 7 – Examples of test arrangements

The test current to be applied is given in Figure 8.

The cross-section to be used when applying Figure 8 is the cross-section calculated with the number of strands and the nominal diameter of one strand.

The test current values as presented in Figure 8 apply only to crimped connections made with crimp barrels according to 4.3 and conductors according to 4.4.

Test severity: 20 or 500 cycles.

NOTE For further information on wires, see IEC 60189-3.

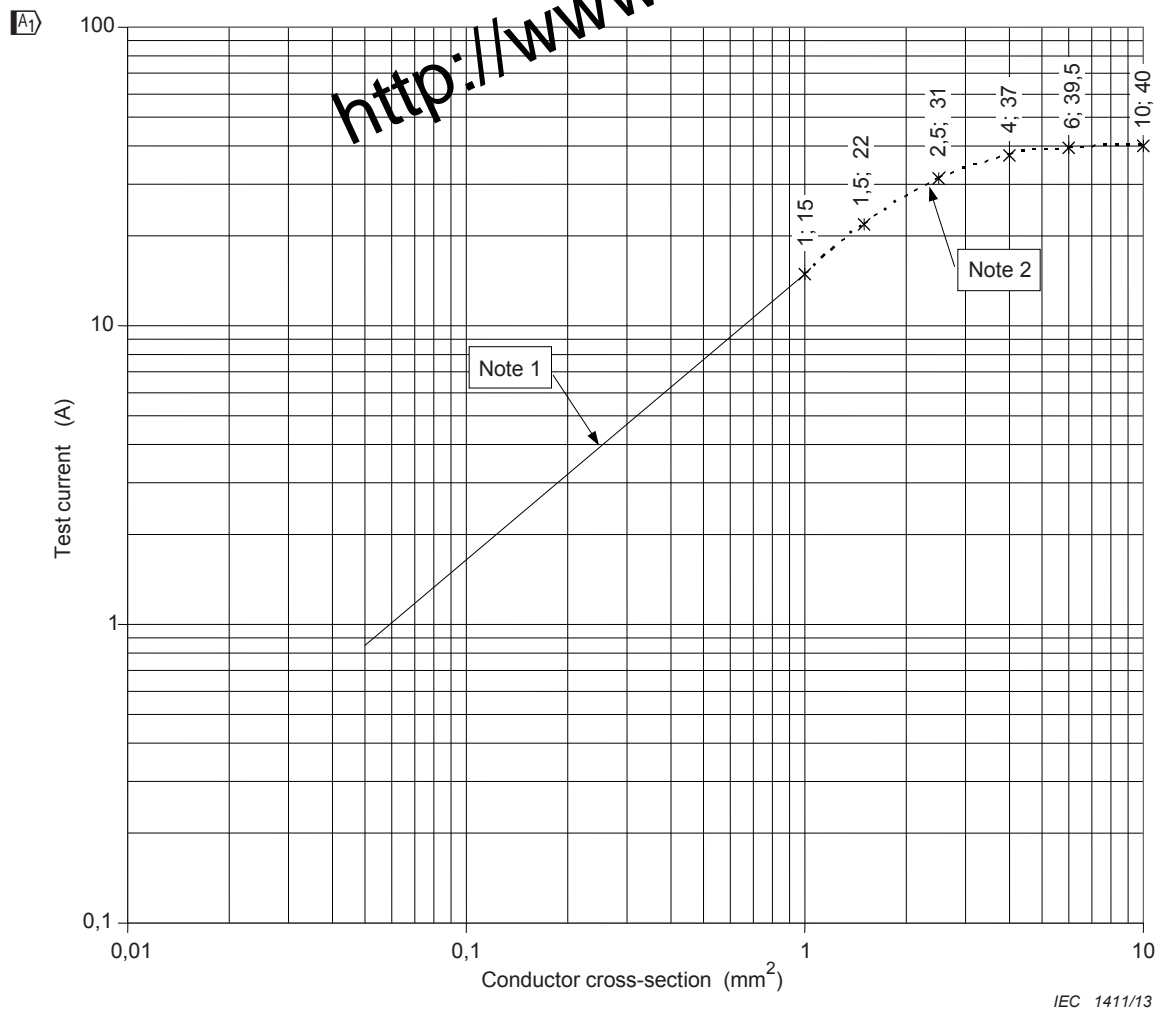

NOTE 1 Test current = $15 \times C^{0.958}$ for conductor cross-sections from 0,05 mm² to 1 mm², where C is the wire cross-section in mm²

NOTE 2 Test current references for conductor cross-sections above 1 mm².

Figure 8 – Test current for crimped connections \square A1

5.2.4.6 Crimping at low temperature (crimped connections with pre-insulated crimp barrels)

Under consideration.

5.2.5 Miscellaneous tests

5.2.5.1 Fluid resistance of pre-insulated crimp barrels

If the test is required, it shall be carried out in accordance with test 19a of IEC 60512.

The test shall be carried out with cleaning fluids only. Fluid and test temperature shall be specified in the detail specification.

Proof voltage: 1 500 V r.m.s. 45 Hz to 60 Hz

5.3 Test schedules

5.3.1 General

5.3.1.1 General

Prior to testing, the required number and types of specimens are to be prepared.

When crimped connections with crimp barrels designed to accept a range of conductor cross-sections are to be tested, all tests of the applicable test schedule shall be carried out:

- with the specified number of specimens having the maximum conductor cross-section and, additionally,
- with the specified number of specimens having the minimum conductor cross-section.

Before the specimens are prepared, it shall be verified that:

- correct crimp barrels and wires are used;
- the correct crimping tool is used;
- the tool works correctly;
- the operator is able to produce crimped connections, which comply with 4.5.

For all specimens, the minimum wire length shall be 150 mm or as specified in 5.3.1.5.

5.3.1.2 Type A specimen (for tests according to 5.3.2.3.1 and 5.3.3.3.2)

A type A specimen consists of an uninsulated or pre-insulated crimp barrel with or without insulation grip and a wire crimped to the crimp barrel to provide electrical connection between the wire and barrel only.

Any existing insulation grip shall be rendered inoperative.

Typical examples of type A specimens are shown in Figure 9.

<http://www.china-gauges.com/>

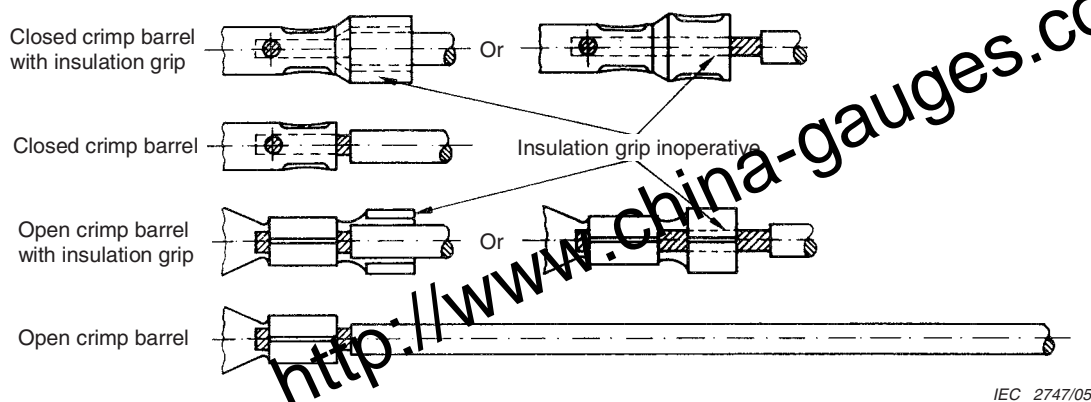

Figure 9 – Examples of type A specimens

5.3.1.3 Type B specimen (for insulation grip effectiveness tests, see 5.3.2.3.3 and 5.3.3.4)

A type B specimen consists of an uninsulated or pre-insulated crimp barrel with insulation grip and an unstripped wire, with the insulation grip only being compressed on the un-stripped wire.

The unstripped wire shall be inserted into the insulation grip only, so that it is only compressed at the insulation grip when the normal crimping operation is carried out. There shall be no electrical or mechanical connection between the wire and that part of the barrel which is normally intended to provide for the electrical connection.

Typical examples of type B specimens are shown in Figure 10.

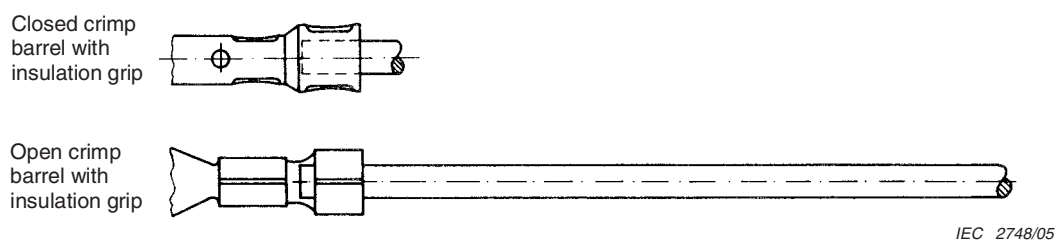

Figure 10 – Examples of type B specimens

5.3.1.4 Type C specimen (for testing of pre-insulated crimp barrels only, see 5.3.2.3.4 and 5.3.3.5)

A type C specimen consists of a pre-insulated crimp barrel with or without insulation grip and a wire crimped to the crimp barrel to provide electrical connection between the wire and the barrel.

Where insulation grip exists, it shall be compressed as well.

At the other end of the wire, the insulation shall be removed in such a manner that test 4c of IEC 60512, can be carried out.

A typical example of type C specimen is shown in Figure 11.

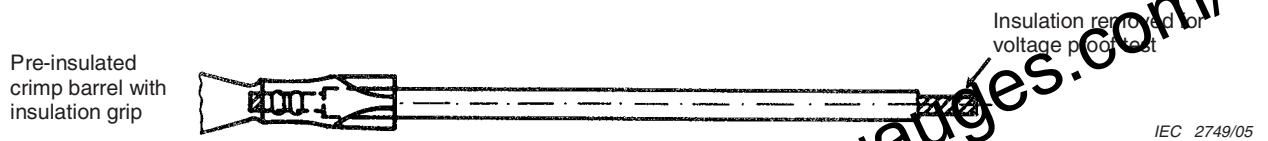

Figure 11 – Example of type C specimen

5.3.1.5 Type D specimen (for tests according to 5.3.2.3.2, 5.3.3.3.3 and 5.3.3.3.4)

A type D specimen consists of an uninsulated or pre-insulated crimp barrel with or without insulation grip and a wire crimped to the crimp barrel to provide electrical connection between the wire and barrel.

Where insulation grip exists, it shall be compressed as well.

The insulation of the wire shall be removed in such a manner that the contact resistance can be measured according to 5.2.3.1.

If the type D specimen is intended to be used for the current loading cyclic test according to 5.2.4.5, the conductor cross-section shall be the largest recommended for the crimp barrel. In this case, the length of the wires shall be 200 mm minimum.

Typical examples of type D specimens are shown in Figure 12.

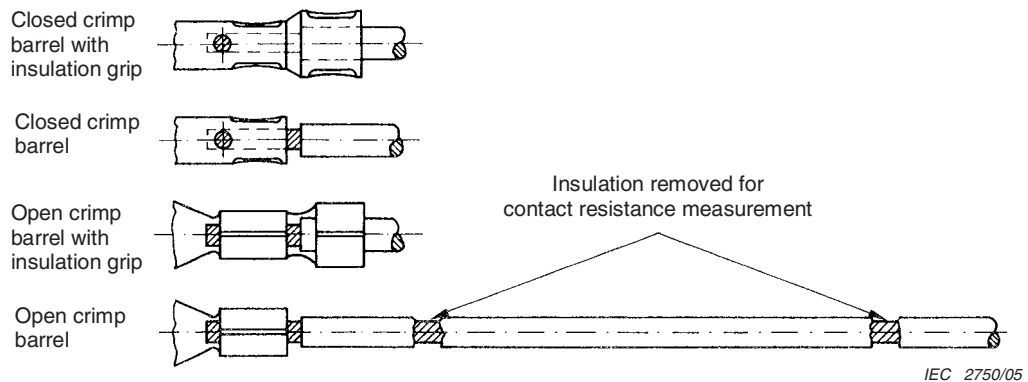

Figure 12 – Examples of type D specimens

5.3.1.6 Type E specimen (for testing of pre-insulated crimp barrels according to 5.3.3.5.4)

A type E specimen consists of a pre-insulated crimp barrel with or without insulation grip and a stripped wire, both necessary for a crimped connection to be made.

At the other end of the wire, the insulation shall be removed in such a manner that test 4c of IEC 60512, can be carried out.

At this stage, the two parts are separate and are required only for the low temperature test according to 5.2.4.6.

A typical example of a type E specimen is shown in Figure 13.

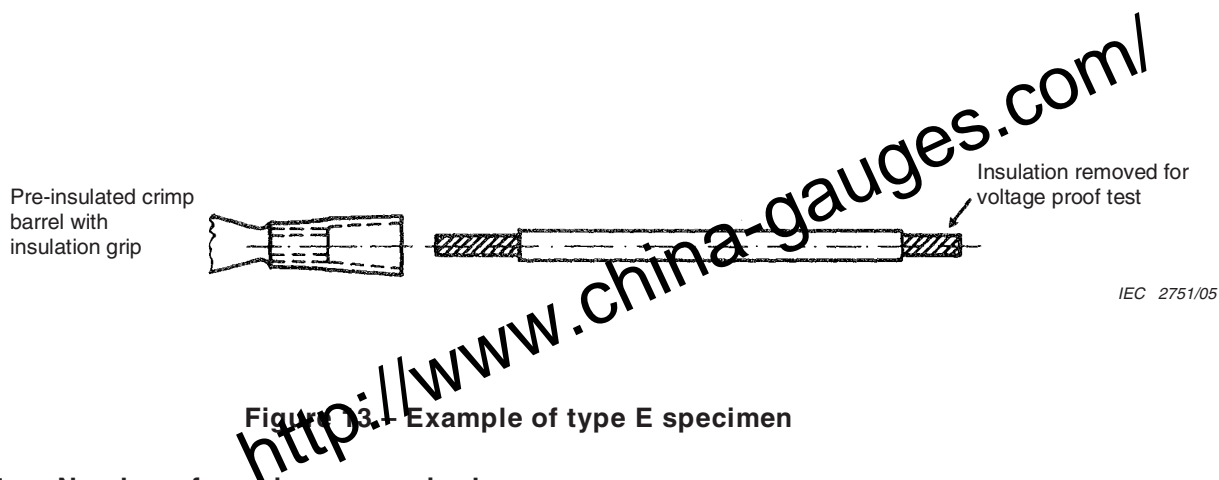

IEC 2751/05

Figure 13. Example of type E specimen

5.3.1.7 Number of specimens required

Table 3 – Number of specimens

| Test schedule | Type of specimen according to 5.3.1 | Required in all cases | Additionally required, when | | |
|------------------------------|-------------------------------------|-----------------------|--|---|--|
| | | | Unplated barrels and/or wires are to be tested | Insulation grip effectiveness is to be tested | Pre-insulated crimp barrels are to be tested |
| Basic test schedule of 5.3.2 | A | 20 | - | - | - |
| | B | - | - | 6 | - |
| | C | - | - | - | 6 |
| | D | - | 20 | - | - |
| Full test schedule of 5.3.3 | A | 16 | - | - | - |
| | B | - | - | 6 | - |
| | C | - | - | - | 6, if test group F is required |
| | D | 24 | - | - | - |
| | E | - | - | - | 6 |

NOTE For testing crimped connections with crimp barrels designed to accept a range of conductor cross-sections, see 5.3.1.

5.3.2 Basic test schedule

5.3.2.1 General

Where the basic test schedule is applicable (see 5.1.1), the number of type A specimens in Table 3 shall be prepared and subjected to the test according to 5.3.2.3.1.

When crimped connections made with unplated barrels and/or unplated conductors are to be tested, the additional number of type D specimens specified in Table 3 shall be prepared and subjected to the test according to 5.3.2.3.2.

When crimp barrels with insulation grip are to be tested, the additional number of type B specimens specified in Table 3 shall be prepared and subjected to the test according to 5.3.2.3.3.

When pre-insulated crimp barrels are to be tested, the number of additional type C specimens specified in Table 3 shall be prepared and subjected to the test according to 5.3.2.4.

5.3.2.2 Initial examination

All specimens shall be subjected to test 1a of IEC 60512. If specified by the detail specification for the component using the crimp contacts, test 16g of IEC 60512, shall be performed.

5.3.2.3 Testing of crimped connections

5.3.2.3.1 Testing of crimped connections made with crimp barrels according to 4.3 and wires according to 4.4

20 type A specimens.

After the initial examination, all specimens shall be subjected to the following test in Table 4.

Table 4 – Test group P1

| Test phase | Test | | Measurement to be performed | | Requirement |
|------------|--------------------------------------|-------------------------------|-----------------------------|--------------------|-------------|
| | Title | Severity or condition of test | Title | IEC 60512 Test No. | |
| P1 | Pull out force (crimped connections) | 5.2.2.1 | | 16d | 5.2.2.1 |

5.3.2.3.2 Additional testing of crimped connections made with unplated crimp barrels according to 4.3 and/or un-plated wires according to 4.4

20 type D specimens.

After the initial examination, all specimens shall be subjected to the following test in Table 5.

Table 5 – Test group P2

| Test phase | Test | | Measurement to be performed | | Requirement |
|------------|------------------------|-------------------------------|-----------------------------|--------------------|-------------|
| | Title | Severity or condition of test | Title | IEC 60512 Test No. | |
| P2.1 | | | Contact resistance | 2a or 2b | 5.2.3.1 |
| P2.2 | Current loading cyclic | 5.2.4.5 20 cycles | | 9e | 5.2.4.5 |
| P2.3 | | | Contact resistance | as P2.1 | 5.2.3.1 |

5.3.2.3.3 Additional testing of crimp barrels with insulation grip

6 type B specimens.

After the initial examination, all specimens shall be subjected to the following test in Table 6.

Table 6 – Test group P3

| Test phase | Test | | Measurement to be performed | | Requirement |
|------------|---|-------------------------------|-----------------------------|--------------------|-------------|
| | Title | Severity or condition of test | Title | IEC 60512 Test No. | |
| P3 | Insulation grip effectiveness (crimped connections) | 5.2.2.2 | | 16h | 5.2.2.2 |

5.3.2.3.4 Additional testing of crimped connections with pre-insulated crimp barrels

6 type C specimens.

After the initial examination, all specimens shall be subjected to the following test in Table 7.

Table 7 – Test group P4

| Test phase | Test | | Measurement to be performed | | Requirement |
|------------|--|-------------------------------|-----------------------------|--------------------|-------------|
| | Title | Severity or condition of test | Title | IEC 60512 Test No. | |
| P4 | Voltage proof of pre-insulated crimp barrels | 5.2.3.2 | | 4c | 5.2.3.2 |

5.3.3 Full test schedule

5.3.3.1 General

Where the full test schedule is applicable (see 5.1.1) the number of type A and type D specimens specified in Table 3 shall be prepared and subjected to the test according to 5.3.3.3.

When crimp barrels with insulation grip are to be tested, the additional number of type B specimens specified in Table 3 shall be prepared and subjected to the test according to 5.3.3.4.

When pre-insulated crimp barrels are to be tested, the number of additional type C and type E specimens specified in Table 3 shall be prepared and subjected to the test according to 5.3.3.5.

5.3.3.2 Initial examination

All specimens shall be subject to test 1a of IEC 60512.

If specified by the detail specification for the component using the crimp contacts, test 16g of IEC 60512 shall be performed.

5.3.3.3 Testing of crimped connections

5.3.3.3.1 General

After the initial examination per 5.3.3.2,

- 16 type A specimens shall be subject to the tests according to 5.3.3.3.2 (test group A);
- 8 type D specimens shall be subject to the tests according to 5.3.3.3.3 (test group B);
- 16 type D specimens shall be subject to the tests according to 5.3.3.3.4 (test group C).

5.3.3.3.2 Test group A

16 type A specimens. See Table 8.

Table 8 – Test group A

| Test phase | Test | | Measurement to be performed | | Requirement |
|------------|--------------------------------------|-------------------------------|-----------------------------|--------------------|-------------|
| | Title | Severity or condition of test | Title | IEC 60512 Test No. | |
| AP 1 | Pull out force (crimped connections) | 5.2.2.1 | | 16d | 5.2.2.1 |

5.3.3.3.3 Test group B

8 type D specimens. See Table 9.

Table 9 – Test group B

| Test phase | Test | | Measurement to be performed | | Requirement |
|------------|------------------------|-------------------------------|-----------------------------|--------------------|-------------|
| | Title | Severity or condition of test | Title | IEC 60512 Test No. | |
| BP 1 | | | Contact resistance | 2a or 2b | 5.2.3.1 |
| BP 2 | Current loading cyclic | 5.2.4.5 500 cycles | | 9e | 5.2.4.5 |
| BP 3 | | | Contact resistance | as BP 1 | 5.2.3.1 |

5.3.3.3.4 Test group C

16 type D specimens. See Table 10.

Table 10 – Test group C

| Test phase | Test | | Measurement to be performed | | Requirement |
|------------|-------------------------------------|-------------------------------|-----------------------------|--------------------|-------------|
| | Title | Severity or condition of test | Title | IEC 60512 Test No. | |
| CP 1 | | | Contact resistance | 2a or 2b 11d | 5.2.3.1 |
| CP 2 | Rapid change of temperature | 5.2.4.2 | | | |
| CP 3 | Climatic sequence | 5.2.4.4 | | 11a | |
| CP 3.1 | Dry heat | 5.2.4.4 | | 11i | |
| CP 3.2 | Damp heat, cyclic, | 5.2.4.4 | | 11m | |
| CP 3.3 | Cold | 5.2.4.4 | | 11j | |
| CP 3.4 | Damp heat, cyclic, remaining cycles | 5.2.4.4 5 cycles | | 11m | |
| CP 4 | | | Contact resistance | as CP 1 | 5.2.3.1 |

5.3.3.4 Testing of insulation grip effectiveness, test group D

6 type B specimens.

After the initial examination, all specimens shall be subject to the following test in Table 11.

Table 11 – Test group D

| Test phase | Test | | Measurement to be performed | | Requirement |
|------------|---|-------------------------------|-----------------------------|--------------------|-------------|
| | Title | Severity or condition of test | Title | IEC 60512 Test No. | |
| DP1 | Insulation grip effectiveness (crimped connections) | 5.2.2.2 | | 16h | 5.2.2.2 |

5.3.3.5 Testing of crimped connections with pre-insulated crimp barrels

5.3.3.5.1 General

After the initial examination per 5.3.3.2, 6 type C specimens shall be subject to the tests according to 5.3.3.5.2 (test group E).

Provided that the fluid resistance test 5.2.5.1 is required, additionally 6 type C specimens shall be initially examined and then be subject to the tests according to 5.3.3.5.3 (test group F).

After the general examination, the 6 type E specimens (6 sets of separate parts) shall be subject to the tests according to 5.3.3.5.4 (test group G).

5.3.3.5.2 Test group E

6 type C specimens. See Table 12.

Table 12 – Test group E

| Test phase | Test | | Measurement to be performed | | Requirement |
|------------|----------|-------------------------------|--|--------------------|-------------|
| | Title | Severity or condition of test | Title | IEC 60512 Test No. | |
| EP 1 | Dry heat | 5.2.4.3 | | | |
| EP 2 | | | Visual examination | 1a | |
| EP 3 | | | Voltage proof of pre-insulated crimp barrels | | 5.2.3.2 |

5.3.3.5.3 Test group F, if required

6 type C specimens. See Table 13.

Table 13 – Test group F

| Test phase | Test | | Measurement to be performed | | Requirement |
|------------|---|-------------------------------|-----------------------------|--------------------|-------------|
| | Title | Severity or condition of test | Title | IEC 60512 Test No. | |
| FP 1 | Fluid resistance of pre-insulated crimp barrels | 5.2.5.1 | | 19a | 5.2.5.1 |

5.3.3.5.4 Test group G

6 type E specimens. See Table 14.

Table 14 – Test group G

| Test phase | Test | | Measurement to be performed | | Requirement |
|------------|-----------------------------|-------------------------------|--|--------------------|-------------|
| | Title | Severity or condition of test | Title | IEC 60512 Test No. | |
| GP 1 | Crimping at low temperature | 5.2.4.6 u.c. | | | |
| GP 2 | | | Visual examination | 1a | |
| GP 3 | | | Voltage proof of pre-insulated crimp barrels | | 5.2.3.2 |

5.3.4 Flow charts

For quick orientation, the test schedule detailed in 5.3.2 and 5.3.3 are repeated as flow charts in a simplified manner in Figures 14 and 15 respectively.

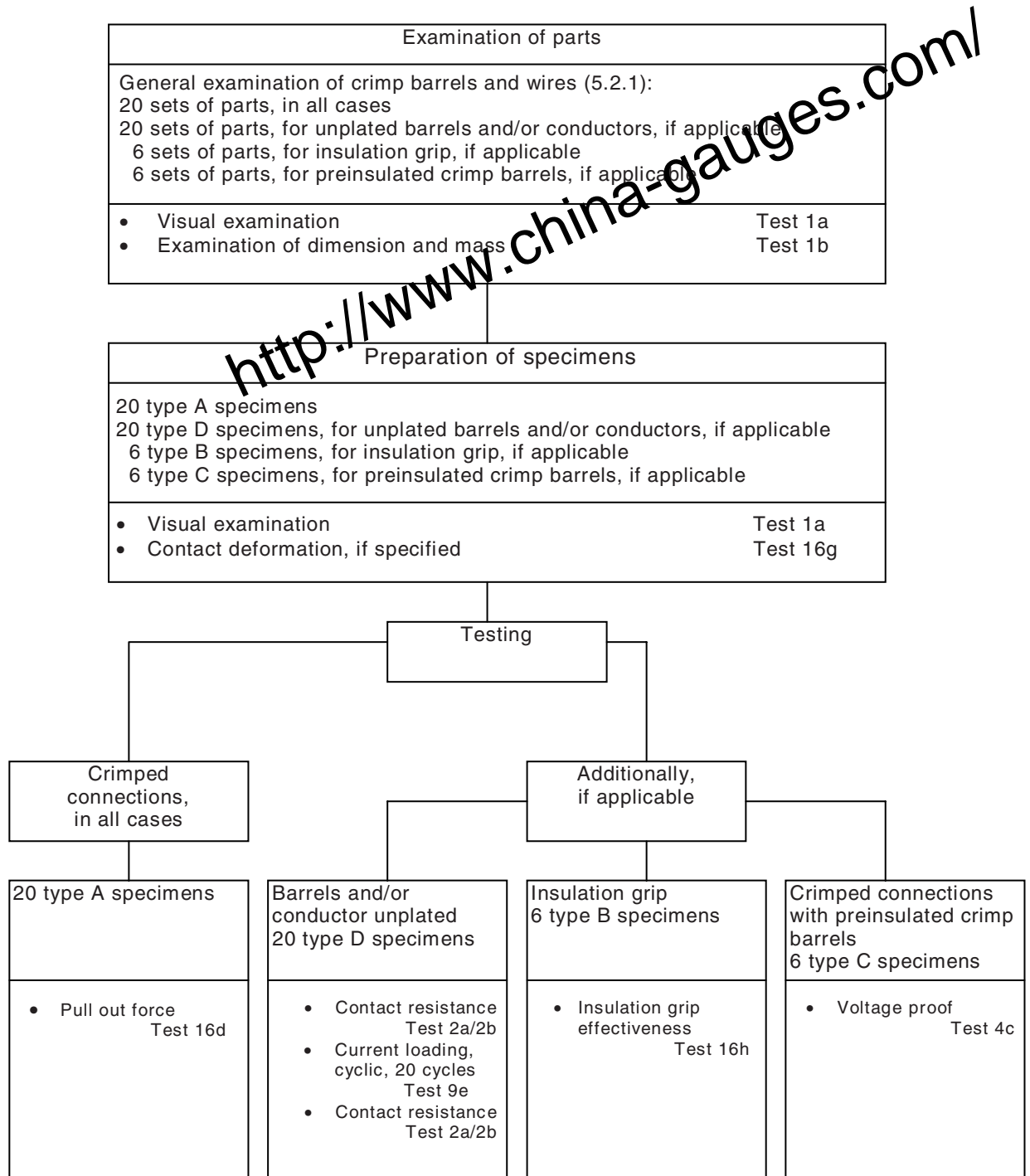

Figure 14 – Basic test schedule (see 5.3.2)

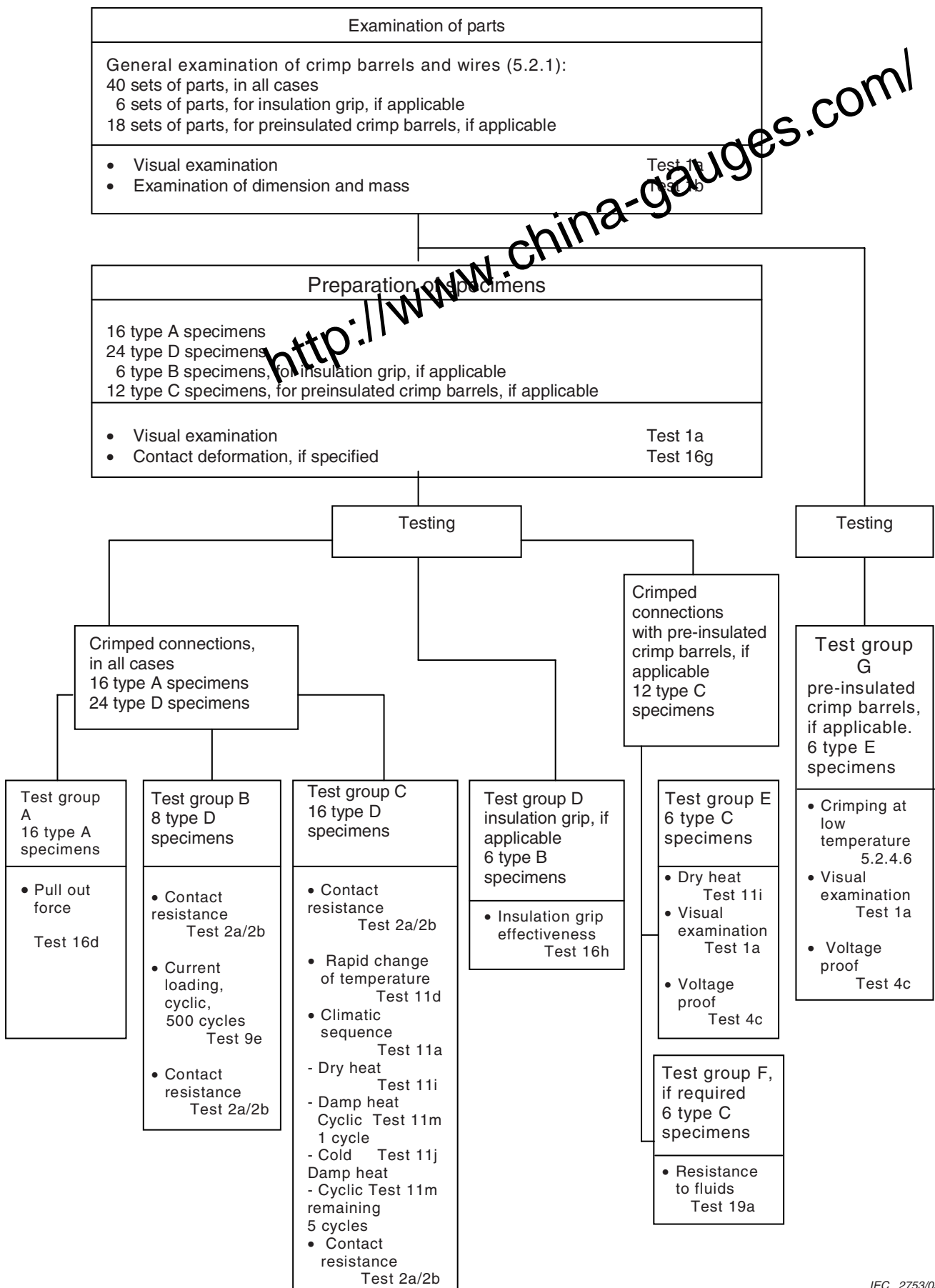

Figure 15 – Full test schedule (see 5.3.3)

6 General information on crimp connections

6.1 General

This practical guidance applies to crimped connections made with stranded copper conductors produced by crimping tools (fully-automatic, semi-automatic crimping machines or hand-operated crimping tools). Solid copper conductors or conductors made of other materials (aluminium, steel, etc.) often require special care regarding the contacts and the crimping tools, which should be agreed with the manufacturer.

6.2 Advantages of crimped connections

A connection made by crimp technique is a non-releasable electrical connection between one or more conductors with a crimp contact of any shape. Good electrical connection is achieved by exact matching of crimping dies, crimp barrels and the conductors' cross-section by pressure deformation and retaining of the barrel.

The advantages are as follows:

- efficient processing of connections at each production level;
- processing by fully-automatic or semi-automatic crimping machines, or with hand-operated tools;
- no cold-soldered joints;
- no degradation of the spring characteristic of female contacts by the soldering temperature;
- no health risk from heavy metal and flux steam;
- preservation of conductor flexibility behind the crimped connection;
- no burnt, discoloured and overheated wire insulation;
- good connections with reproducible electrical and mechanical performances;
- easy production control.

6.3 Current-carrying capacity considerations

In general, the total area of contact between the conductor and the crimp barrel of a crimped connection made to this standard should result in a larger cross-section than that of the wire used.

It should be taken into account that the current-carrying capacity can be influenced by:

- ambient temperature;
- contact material;
- surface finish of the contact;
- cross-section of the conductor;
- surface finish of the conductor;
- number of positions in a multipole connector;
- pitch (spacing) of a multipole connector.

7 Tool information

The following list includes requirements and recommendations about crimping tools.

- a) Crimping tools and contacts used should be delivered by the same manufacturer, otherwise the user is responsible for a good reliable crimped connection.
- b) Tools shall operate and correctly form the crimp without damaging the barrel or the component to be crimped.
- c) In order to achieve a good reliable crimped connection, usually a crimping tool having a full cycle crimping mechanism is necessary. On completion of the full crimping cycle, the handles and dies or indentors should automatically return to the fully open position. Fully-automatic and semi-automatic crimping machines complete the full crimping cycle automatically.
- d) In any case, the crimping operation should be made in one step. Rework in additional steps should be avoided.
- e) Removable parts of the tool, such as crimping dies and location devices, should be designed that they can only be fitted into the tool in the correct manner.
- f) Tools should be provided with means for the proper location of crimp barrels and wires during the crimping operation.
- g) Tools should be designed so that only the necessary adjustments can be made.
- h) The action of the tool should be such that both the crimp barrel and the insulation grip (if any) are crimped or compressed, respectively, in one operation.
- i) The tool design should ensure that the dies for a particular tool are interchangeable in other tools of that type. Where they are not interchangeable, they should be marked to identify the tool for which they are suitable.
- j) Tools may be designed to produce a die marking or coding upon the crimp barrel, so that the inspection after crimping is possible to verify correct application.
- k) The tool design should allow gauging of the dies to assess wear. The gauging method should be as specified by the tool manufacturer.

8 Crimp barrel information

8.1 General

8.1.1 Open crimp barrels, with or without insulation grip

These are crimp barrels of contacts which are U- or V-shaped before crimping. The contacts are usually delivered in strip form (length or side feed) on reels for fully- or semi-automatic crimping machines. During the crimping process, the crimped contact will be separated from the strip. For low production rates and repair, these contacts can also be delivered in loose piece form for hand crimping tools. The characteristic of contacts with open crimp barrel and insulation grip is a second barrel, which is also reshaped during the crimping process and which secures the end of the wire insulation.

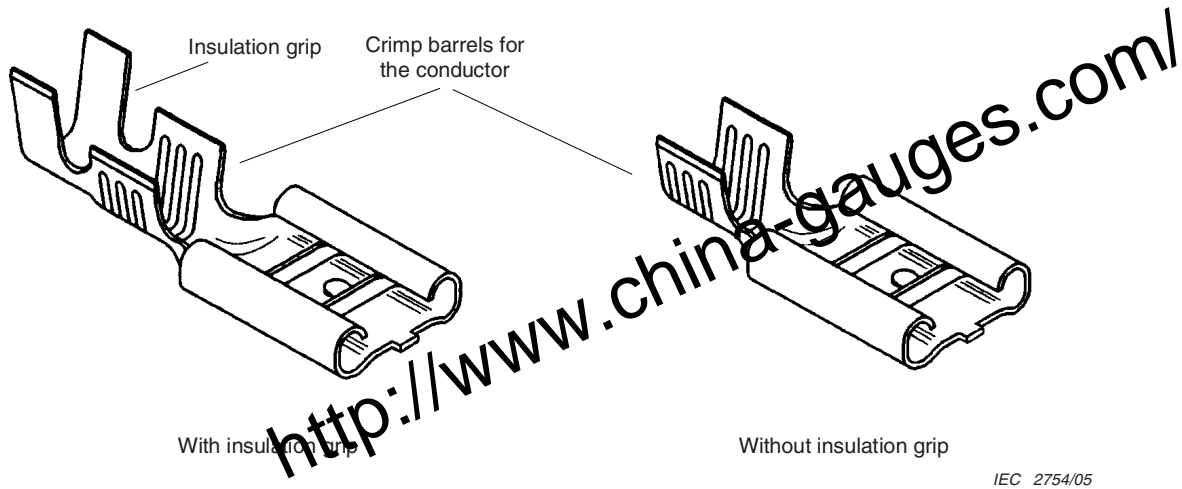

Figure 16 – Open crimp barrels

The basic function of the insulation grip is to absorb mechanical stress like vibration or bending from the crimped connection. Contacts with insulation grip are the most commonly used in practice. Figure 16 shows typical open crimp barrels with and without insulation grips.

8.1.2 Closed crimp barrels, either uninsulated, with or without insulation grip, or pre-insulated, with or without insulation grip

These are crimp barrels of terminals or contacts which are stamped and formed, deep-drawn, screw-machined or manufactured out of tubing. Pre-insulated barrels usually have an insulation sleeve made of polyvinyl chloride, polyamide, etc.

It is recommended that the barrel conductor entry be chamfered as to:

- avoid damage to the conductor;
- ease insertion of the conductor.

Terminals and contacts having closed crimp barrels usually are loose-piece products, but there are also products in strip form (tape-mounted, etc.) on the market.

Figure 17 shows typical closed crimp barrels with and without insulation sleeves.

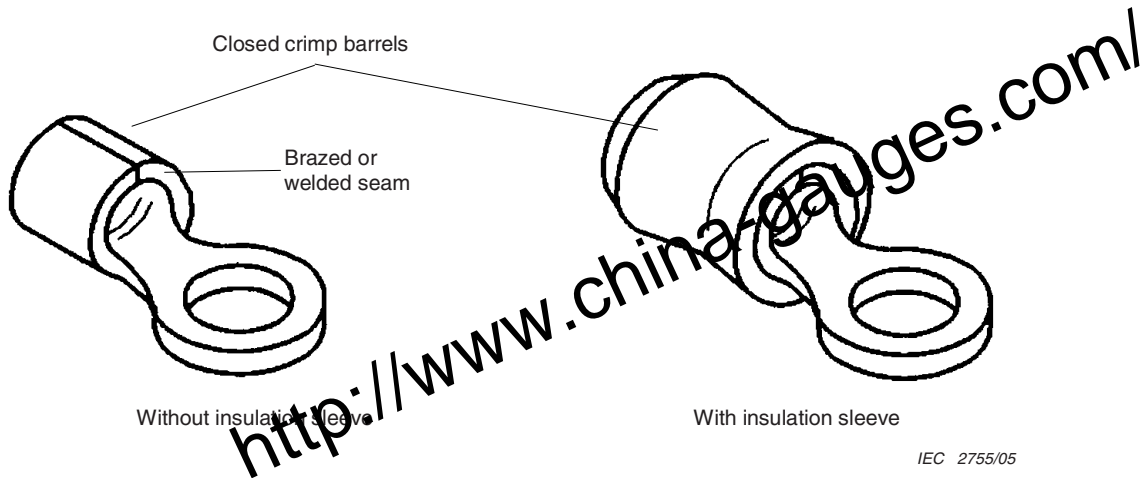

Figure 17 – Closed crimp barrels

8.2 Materials

In addition to the crimp barrel materials specified in 4.3.1, other materials of suitable characteristics may be used, for example nickel, steel, stainless steel.

Materials with a high resistivity coefficient (K values, see 5.2.3.1) may not be suitable for certain applications.

In these cases, the full test schedule of 5.3.3 shall be applied (see 5.1.1).

8.3 Surface finishes

Crimp barrels unplated or plated with materials specified in 4.3.3 are commonly used. Other plating materials, such as nickel, may be used provided their suitability has been proven.

In these cases, the full test schedule of 5.3.3 shall be applied (see 5.1.1).

8.4 Shapes of crimped connections

8.4.1 General

There are different crimping shapes in use, some of which are shown in the figures and cross-sections given in Figures 18 to 22. During the crimping operation, the crimp barrel is deformed from its original cross-section, and it may be additionally deformed along its longitudinal axis. The deformations may increase the relevant dimensions. It may be necessary to limit the increase in dimensions if the crimped connection has to be accommodated in a limited space, for example in a cavity of a component.

8.4.2 Shapes of crimped connections made with contacts having open crimp barrels

See Figures 18 and 19.

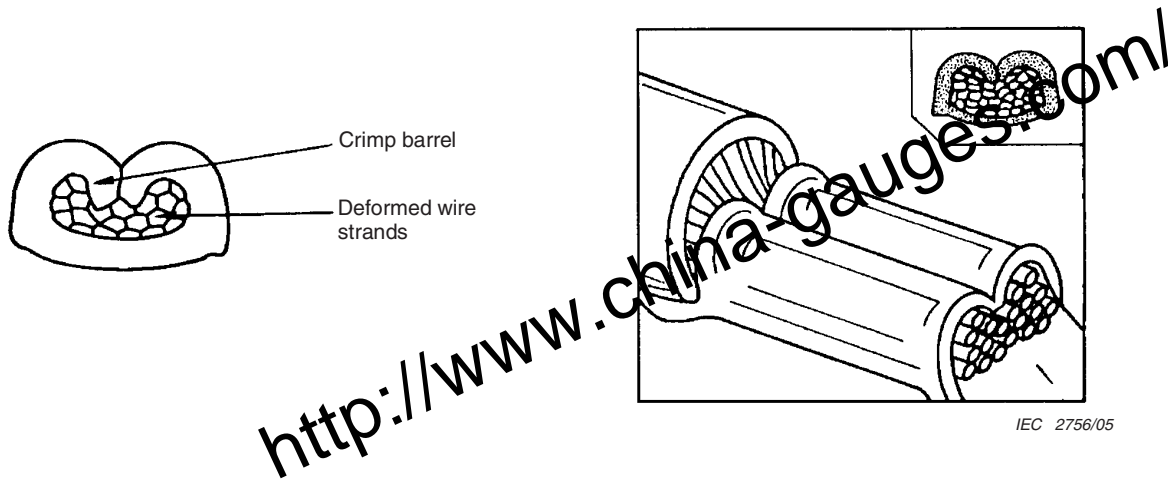

Crimping shape used preferably for crimped connections with the mating area in the wire axis.

Figure 18 – Crimping shape in the wire axis

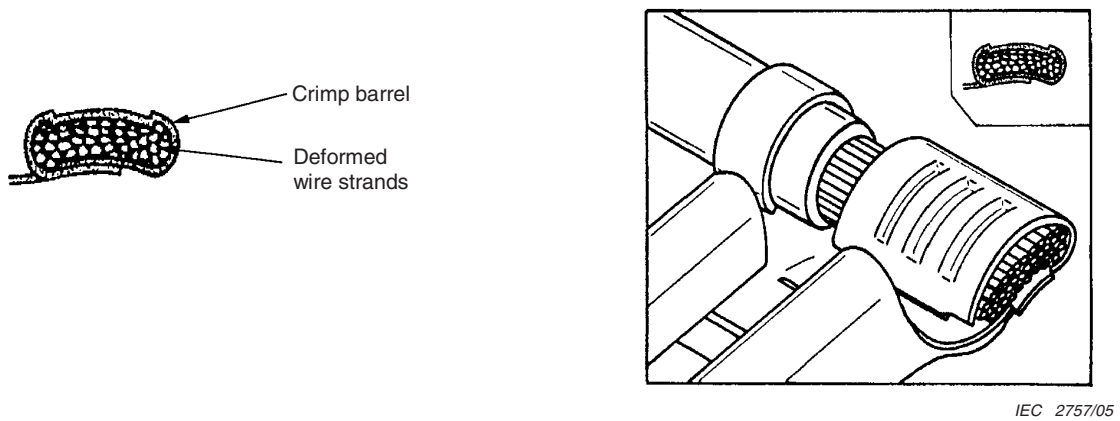

Crimping shape used preferably for crimp connections with the mating area angled 90° to the wire axis.

Figure 19 – Crimping shape 90° angled to the wire axis

8.4.3 Shapes of crimped connections made with terminal ends or contacts having closed crimp barrels

See Figures 20 and 21.

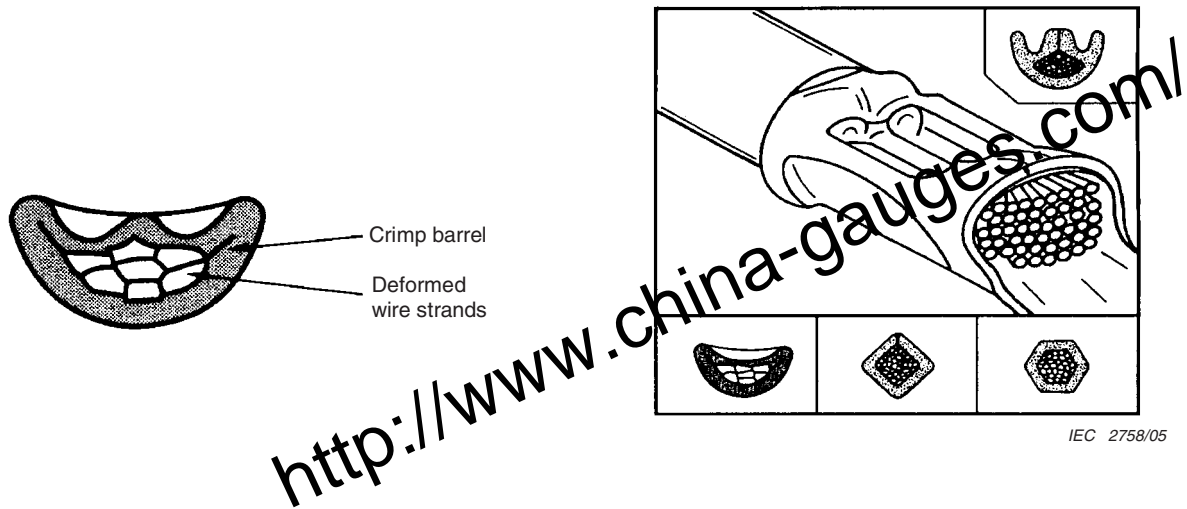

Crimping shape used preferably for crimped connections without insulation grip.

Figure 20 – Crimping shape without insulation grip

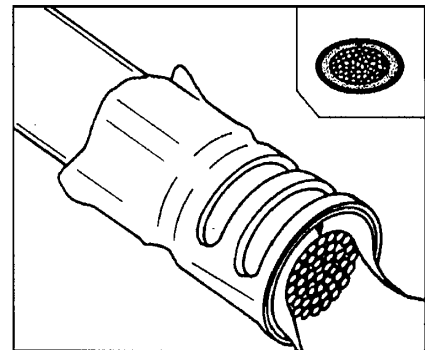
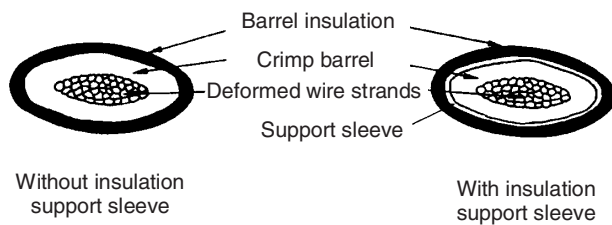

Crimping shape used preferably for crimped connections without pre-insulated crimp barrel.

Figure 21 – Crimping shape with pre-insulation crimp barrel

8.4.4 Shapes of crimped connections made with contacts having screw-machined, closed crimp barrels

See Figure 22.

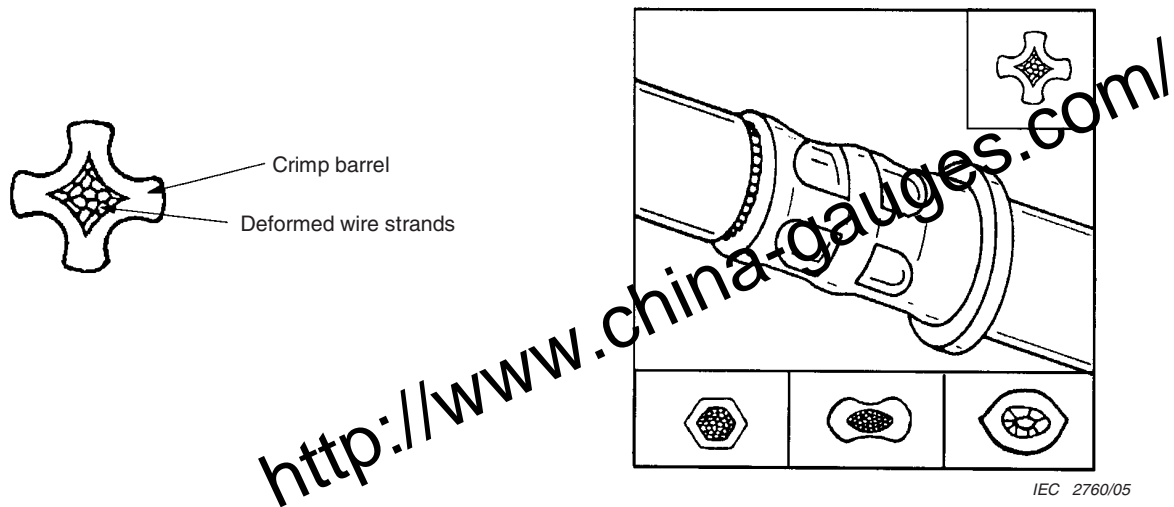

Crimping shape used preferably for crimped connections without pre-insulated crimp barrel.

NOTE Contacts are available having a second barrel, which grips the end of the wire insulation.

Figure 22 – Crimping shape without pre-insulation crimp barrel

9 Wire information

9.1 General

Stranded wires are normally used for crimped connections (see 4.4).

Solid round conductors of 0,25 mm to 3,6 mm diameter may be used provided their suitability has been proven.

Crimped connections using wires with solid round conductors shall be tested to, and meet the requirements of, the full test schedule of 5.3.3 (see also 5.1.1).

Stranded conductors shall not be soldered/tin dipped in that part which is intended to be crimped.

After crimping, no additional soldering should take place.

9.2 Materials

According to 4.4.2, conductors made of annealed copper are commonly used for crimped connections.

The following additional conductor materials may be used:

- copper alloys;
- nickel alloys.

In these cases, the full test schedule of 5.3.3 shall be applied (see also 5.1.1).

9.3 Surface finishes

Unplated conductors or conductors finished with tin, tin-alloy or silver are normally used (see 4.4.4).

Other plating materials, such as nickel, may be used. In this case, the full test schedule of 5.3.3 shall be applied (see also 5.1.1).

9.4 Stripping information

In order to obtain a good and stable crimped connection, it is necessary to provide for correct stripping of the wire, i.e. the required stripping length depends on the type and size of the crimp barrel used. See Figure 23.

After crimping:

- the conductor (strands) should be visible between the crimp barrel and the insulation grip;
- the end of the crimped conductor should protrude out of the front end of the crimp barrel. The mating or termination area shall not be hindered.

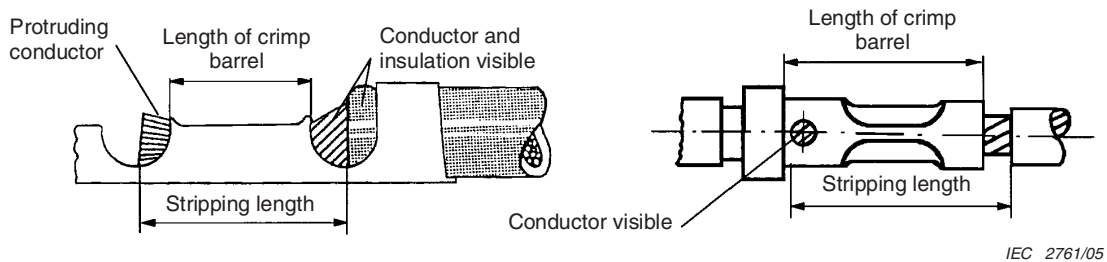

NOTE 1 The manufacturer's instructions regarding stripping length should be followed.

NOTE 2 As rule of thumb: stripping length = length of crimp barrel + 1 mm (up to 1 mm²);
length of crimp barrel + 2 mm (up to 10 mm²).

Figure 23 – Stripping length

If the lay of the strands is disturbed or splayed by stripping, it may be restored by a slight twist. For silver-plated conductors, gloves should be used. Care should be taken not to over-twist the strands (see Figure 25h).

A correctly stripped wire is shown in Figure 24, while Figure 25 shows some examples of stripping faults, which shall be avoided.

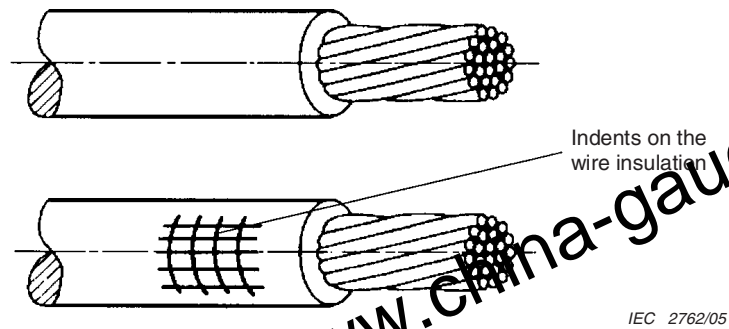

NOTE Indents on the wire insulation caused by the stripping tool which do not damage the insulation are permitted.

Figure 24 – Correctly stripped wire

To avoid damaging the conductor during stripping, the blades of the stripping tools should be adapted according to the conductor diameter and the thickness of insulation.

The following examples of stripping faults (see Figure 25) are often caused by:

- inappropriate handling;
- incorrect adjustment of the stripping tool;
- damaged stripping blades of the stripping tool.

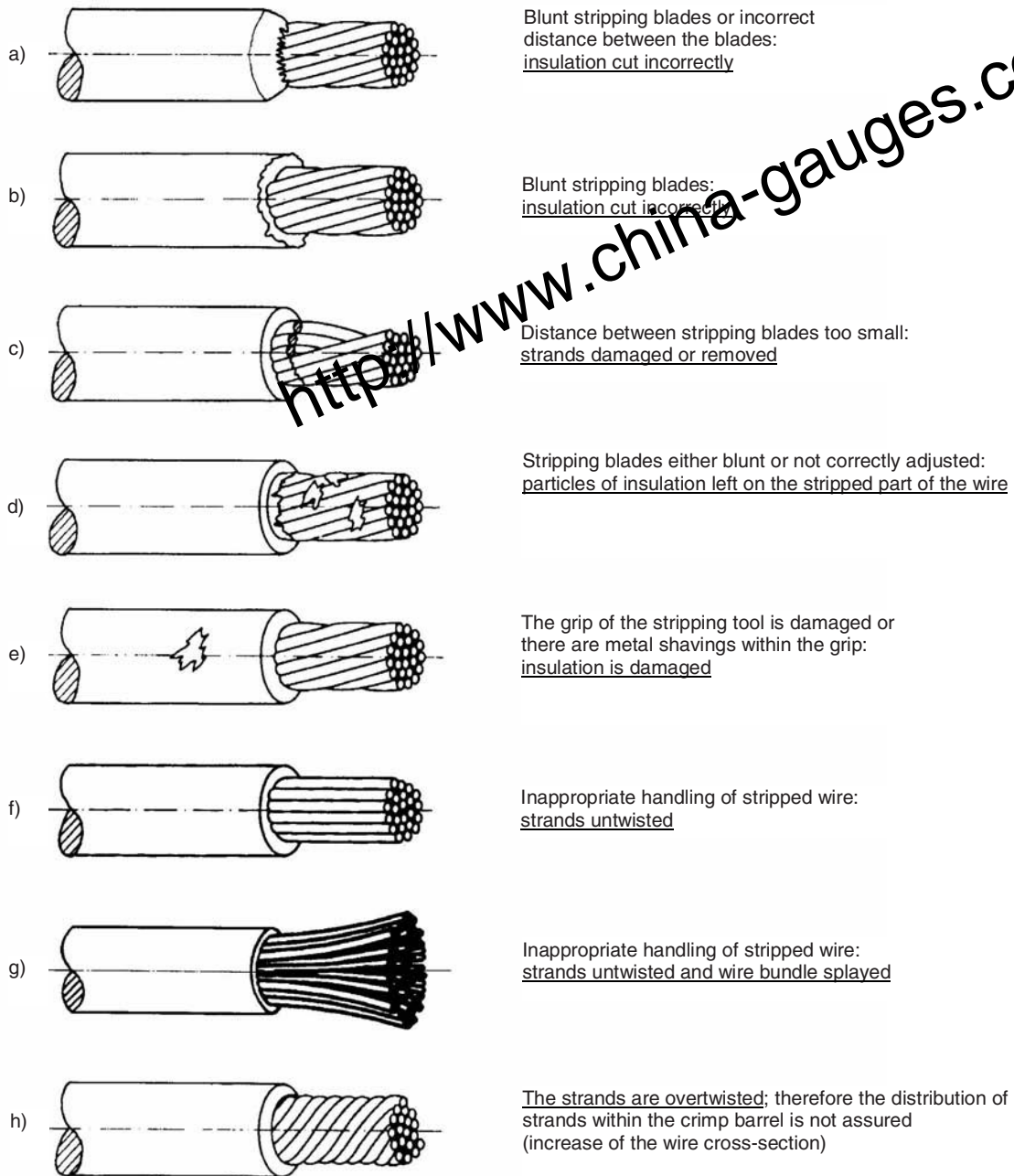

IEC 2763/05

Figure 25 – Examples of stripping faults

10 Connection information

10.1 General

In order to achieve a good, reliable crimped connection, and to meet all the electrical and mechanical requirements, the following details should be specified by the manufacturer:

- assignment of possible conductor cross-sections;
- shape of the crimp barrel (thickness, length, U-contour, etc.);
- crimping profile (crimping width);
- crimp height;
- shape of insulation grip.

Additional information:

- The wire shall be correctly located in the crimp barrel (see Figures 26 and 27).
- The crimp indents shall be correctly located on the crimp barrel (see Figure 27).
- There should be a sufficient, but not too great a distance between the end of the wire insulation and the crimp barrel (see "d" in Figures 26a and 26b).

The manufacturer's instructions regarding this distance should be followed.

- To permit inspection, the conductor (strands) should be visible at both ends of the crimped part of an open crimp barrel (see Figure 26).
- When open crimp barrels with insulation grip are used, the insulation of the wire should be visible in the gap between the insulation grip and the crimped part of the barrel (see Figure 26b).
- When closed crimp barrels having an inspection hole are used, the crimped conductor (strands) should be visible in the hole (see Figure 26b).
- When the crimping operation has to be carried out under field conditions, care should be taken that the surfaces of the crimp barrels and the conductors are clean.

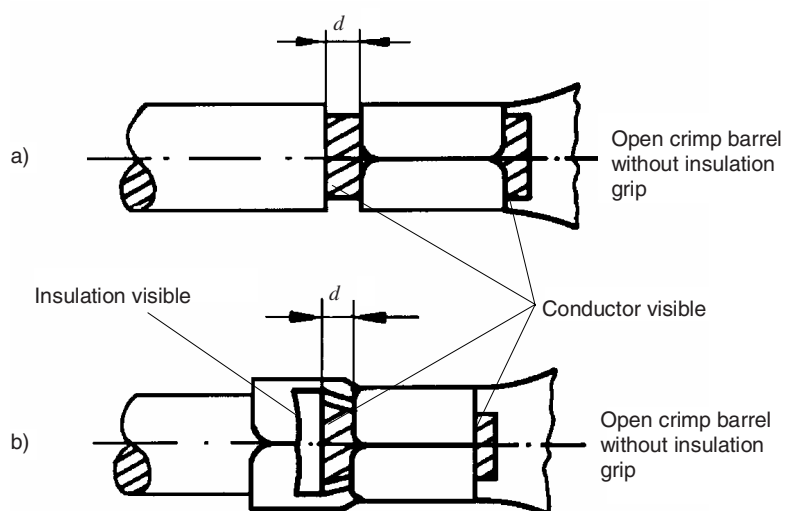

IEC 2764/05

Figure 26 – Examples of correctly crimped connections with open crimp barrels

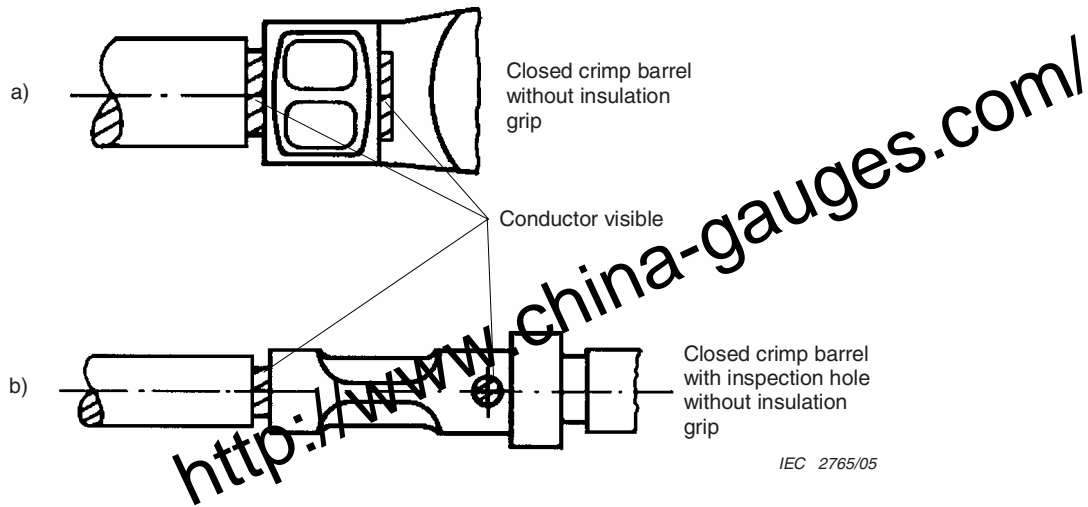
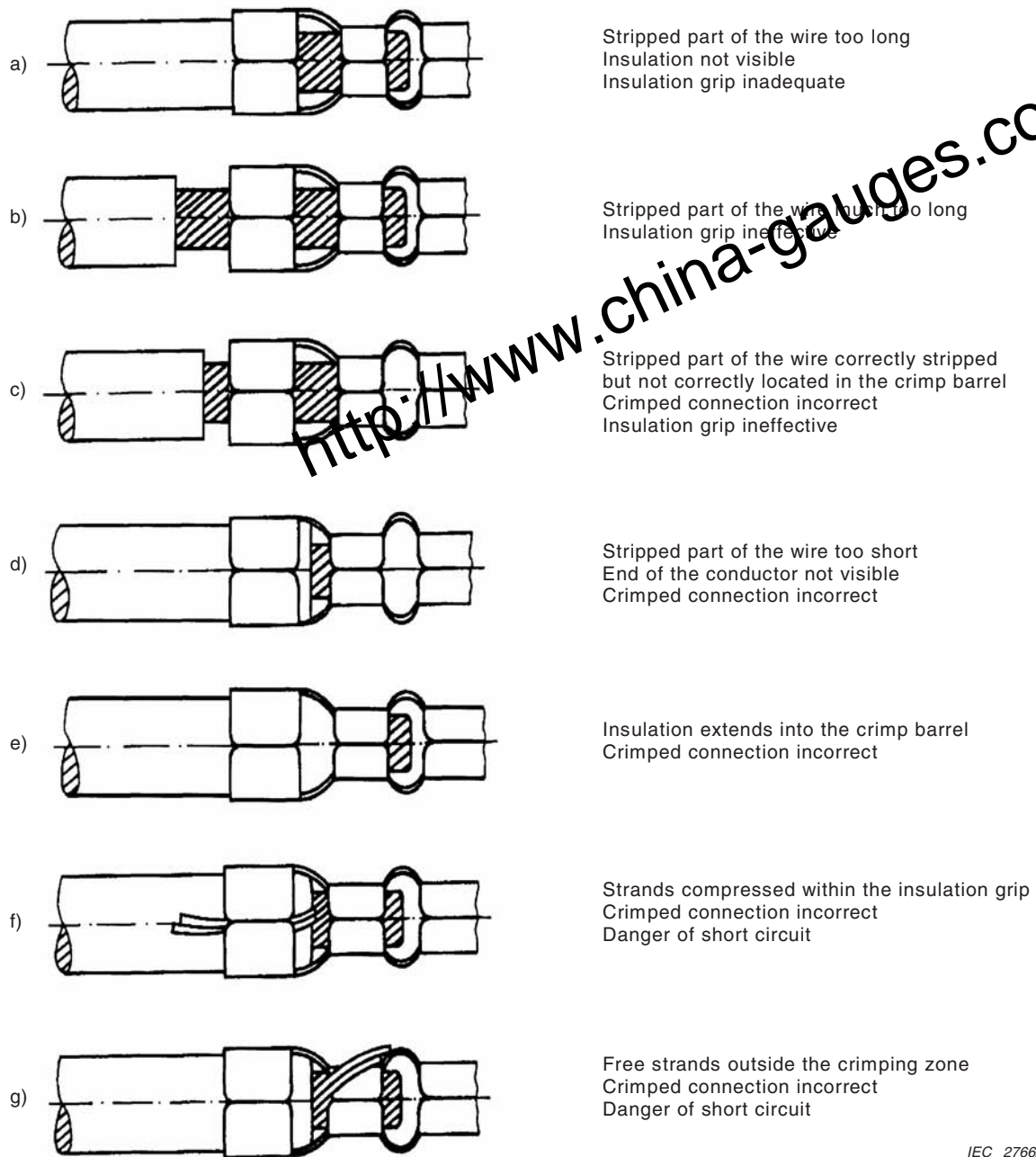

Figure 27 – Examples of correctly crimped connections with closed crimp barrels

The crimped connections made with open crimp barrels shown in Figure 28 should be avoided and they shall not be used.



IEC 2766/05

Figure 28 – Examples of crimping faults with open crimp barrels, with insulation grip

The crimp connections made with closed crimped barrels shown in Figure 29 should be avoided and they shall not be used.

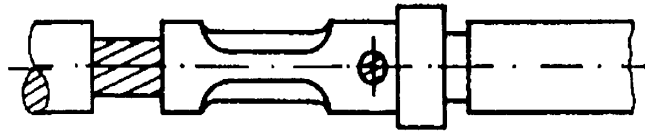

Stripped part of the wire too long, gap between end of insulation and crimp barrel too large
Danger of short circuit

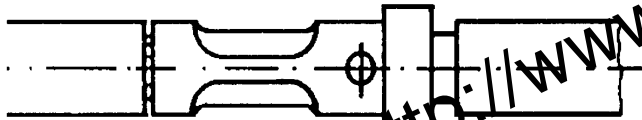

Stripped part of wire too short because the conductor is not visible through the inspection hole
Crimped connection incorrect

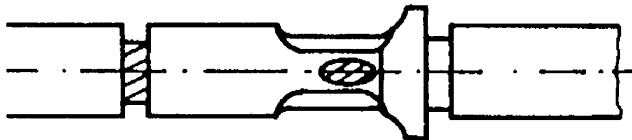

Incorrect location of the contact within the crimping tool
Crimped connection incorrect
Danger of failure

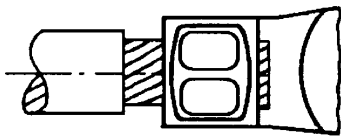

Stripped part of the wire too long, gap between end of insulation and crimp barrel too large
Danger of short circuit

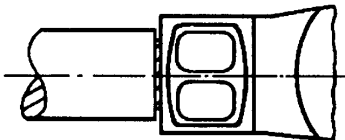

Stripped part of the wire too short because the conductor end is not visible
Crimped connection incorrect

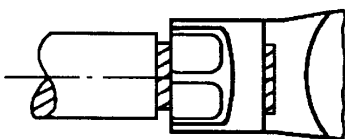

Incorrect location of the contact within the crimping tool
Crimped connection incorrect
Danger of fracture

Figure 29 – Examples of crimping faults with closed crimp barrels, without insulation grip

10.2 Crimped connections made with more than one wire in a crimp barrel

Normally, crimped connections are made with one wire in a crimp barrel; in some industries, the use of more than one wire is deprecated. Where crimped connections are made with more than one wire in a crimp barrel, attention should be paid to:

- the suitability of the wire combinations;
- the compatibility of the crimping part of the crimp barrel, the conductors to be crimped, and the crimping tool;
- the compatibility of the insulation grip, the wires to be secured, and that part of the crimping tool which forms the insulation grip, if applicable;
- the pull out force requirements of the crimped connection.

Where two or more wires are crimped, the mechanical and electrical tests should be performed on each wire in accordance with its requirements.

Crimped connections made with more than one wire in a crimp barrel shall be tested to, and meet the requirements of, the full test schedule of 5.3.3.

NOTE If sealed connectors (sealing at the wire entry side) are used, only one wire in the wire barrel is recommended.

10.3 Dimensions after crimping

The workmanship of the crimped connection should be good. The crimp barrel should not be bent, twisted or deformed by the crimping operation in a way likely to give rise to doubts about the quality of the connection.

10.4 Materials

Care should be taken when selecting the materials and finishes for conductors and crimp barrels to ensure that they are as close as practicable in the electrogalvanic series of metals.

The quality of a crimped connection depends to a high degree on the condition of the surface materials and the quality of both the barrel and the conductor.

In general practice, it is desirable to have comparable deformation in both the conductor and the crimp barrel. This may be facilitated by avoiding combinations of very hard and very soft base materials.

11 Crimping process

11.1 Crimping of contacts with open crimp barrel

Contacts in strip form (side or length feed products) are usually delivered on reels. These contacts should be processed by fully or semi-automatic crimping machines.

11.2 Crimping of contacts with open crimp barrel, loose piece contacts

For small production rates or repair, loose piece contacts can be ordered. These contacts are produced from strip form types and the cut-off tabs have the correct length. The open crimp barrel, as well as the barrel for the insulation grip, is often preformed for better crimping with hand-operated tools.

Attention – It is not recommended to make loose piece contacts by cutting with pliers from strip form products; usually contacts in strip form and loose piece types have different part numbers.

11.3 Processing instruction

For the processing of crimp contacts, attention should be paid to the manufacturer's instructions. These should include the following information:

- workmanship;
- allocation of contacts to the crimp profile of the hand-operated crimping tool (with more than one crimp profile);
- allocation of contacts in strip form to the tool of the crimping machine;
- wire range for which the contact can be used;
- range of wire insulation diameters appropriate for the contact;
- positioning of the contact into the crimping profile of the hand-operated tool;
- stripping length of the wire;
- positioning of the stripped wire into the crimp barrel;
- information about crimp height or depth for 4 or 8 indent crimps used for screw-machined contacts;
- inspection procedure for the crimping tool;
- maintenance of the crimping tool.

Figure 30 shows the crimping process of an open crimp barrel.

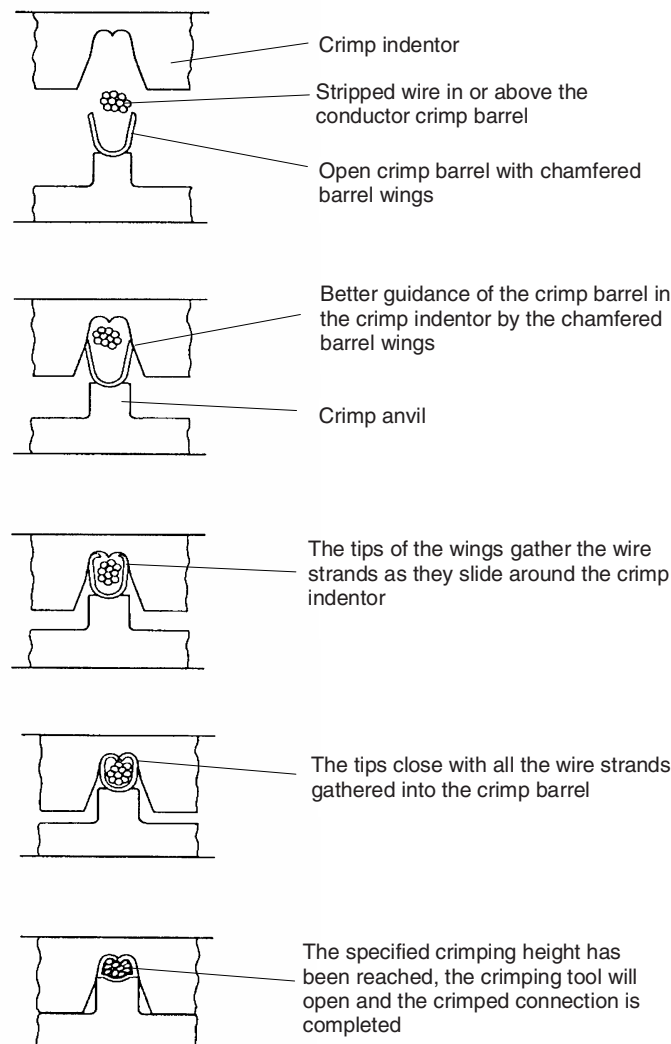

IEC 2768/05

Figure 30 – Crimping process of an open crimp barrel

12 Correct crimped connections (additional information)

12.1 Correct crimped connections of contacts with an open crimp barrel

Figure 31 shows the side view and cross-section of the crimp area of a correctly crimped connection.

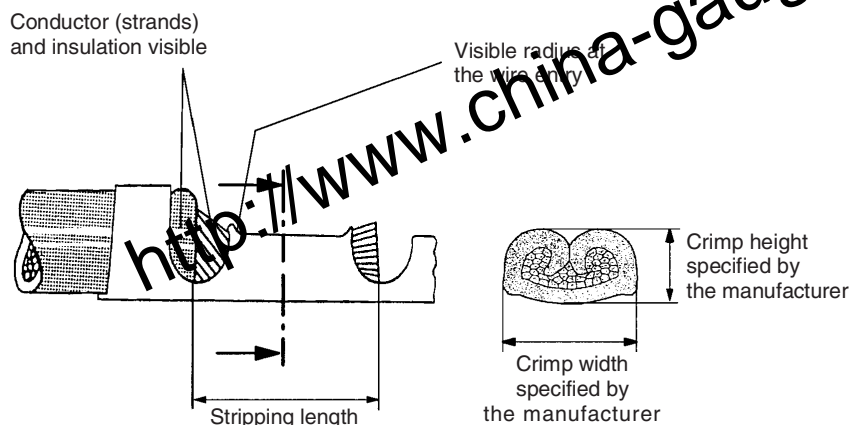

IEC 2769/05

NOTE As rule of thumb: stripping length = length of crimp barrel + 1 mm (up to 1 mm²);
length of crimp barrel + 2 mm (up to 10 mm²).

Figure 31 – Correct crimped connections of contacts with open crimp barrel

To achieve the result shown in Figure 31, attention should be paid to the following:

- the relation between the conductor cross-section and the wire range of the contact used is correct;
- the specified crimping height is respected;
- the conductor strands and wire insulation are visible between the crimped barrel and the insulation grip;
- there is a radius visible at the wire entry side of the crimped barrel (bell mouth), to prevent damaging of the conductor strands; a radius at the opposite side is possible;
- the end of the crimped conductor protrudes from the end of the crimp barrel. The mating or termination area shall not be hindered;
- the wire insulation grip is correct;
- crimped contacts without insulation grip have a sufficient, but not too large distance, between the end of the wire insulation and the crimp barrel.

12.2 Measuring of crimp height/depth

12.2.1 General

For a non-destructive test of crimped connections, the specified crimp height should be monitored by a micrometer during the course of production. The crimp height is directly associated with the quality and the long-term stability of a crimped connection; consequently, the electrical characteristics and the mechanical strength of the crimped connection are directly affected.

The replacement of worn parts within the crimping tool requires new adjustment of the crimp height.

The values for crimp heights or depths shall be provided by the manufacturer.

12.2.2 Measuring instructions

For examples of the measurement of crimp height/depth, see Figure 32.

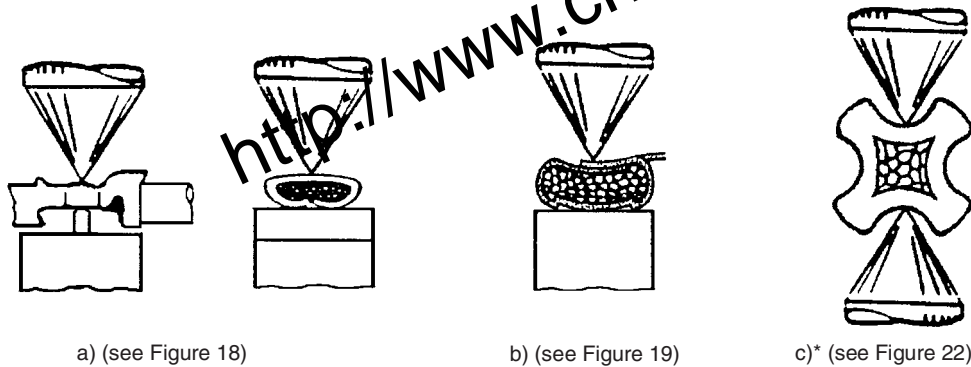

IEC 2770/05

* For the measurement of this crimped connection, a micrometer with two test tips should be used.

NOTE The crimp height/depth of hand-operated crimping tools may be monitored by gauges. The tool manufacturer's instructions should be followed.

Figure 32 – Measuring instructions

12.2.3 Measuring process

Figure 33 shows how to measure the crimp height of a type a) crimped connection shown in Figure 32.

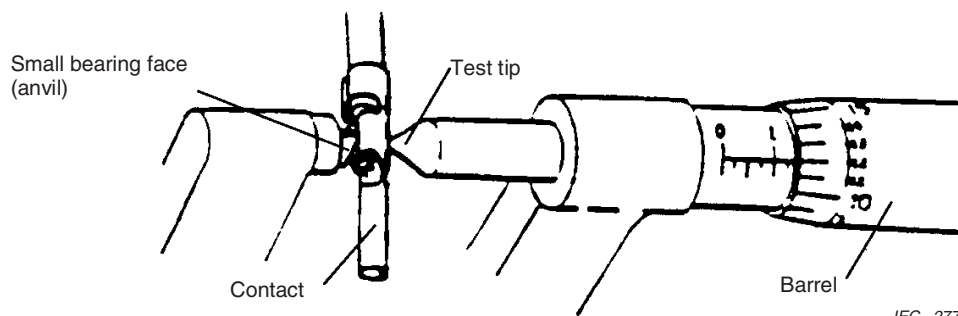

IEC 2771/05

Figure 33 – Measuring process

The formed area of the crimped connection should be placed on the anvil of the micrometer. After that, the scale barrel is turned until the test tip nearly touches the base of the crimped barrel. By turning the ratchet, the test tip will be put in contact with the base of the crimped barrel until the ratchet overwinds. This procedure guarantees that the crimping height is always measured with the same pressure. The value is then read from the scale.

12.3 Insulation grip

In addition to the conductor crimp barrel, most contacts have claws for the insulation grip. The object of these claws is to absorb mechanical stress effects which can come from the direction of the wire bundle/cable. This is particularly valid for vibration and bending stress.

The insulation grip never functions as a cable clamp. The insulation grip should tightly clamp but not pierce through the insulation (see Figure 34).

NOTE Stating a crimp height for the insulation grip is not usual. For requirements and tests, see 5.2.2.2 and test 16h of IEC 60512.

Contacts with open crimp barrels with insulation grip are usually designed for one wire; the crimping of more than one wire, insulation grip included, requires special care which should be agreed with the manufacturer (see 10.2).

Figure 34 shows examples of insulation grip shapes of contacts having open crimp barrels; furthermore, correct, too loose, and too tight insulation grips are shown.

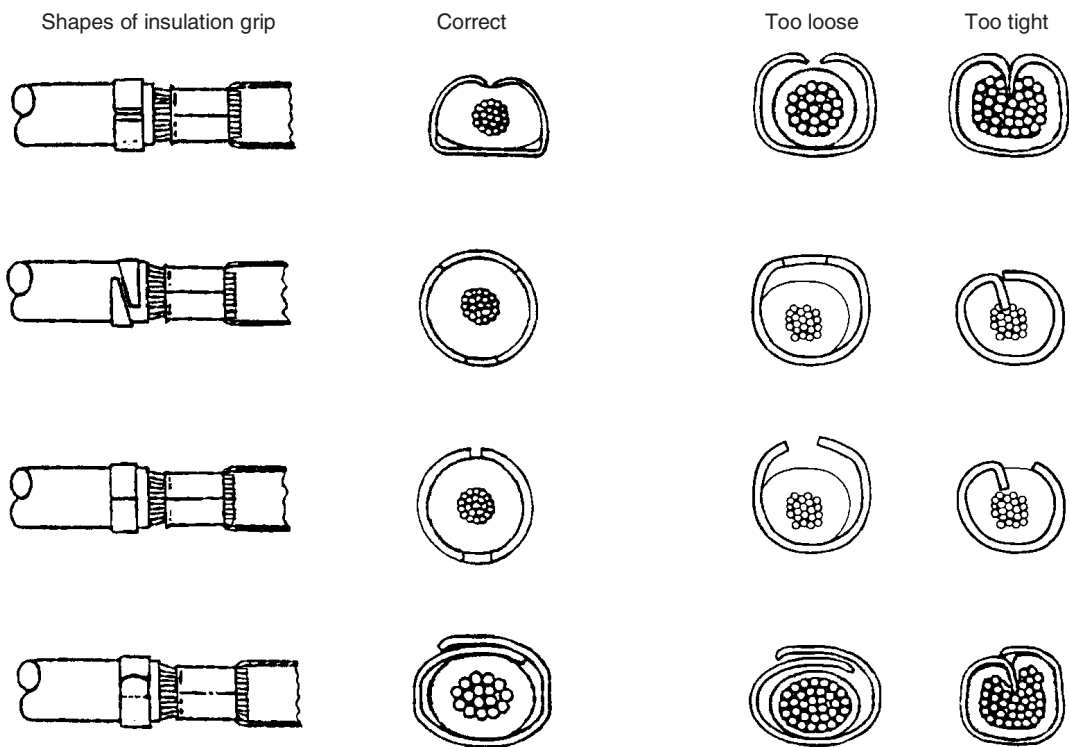

IEC 2772/05

Figure 34 – Examples of insulation grips

13 Faults with crimped contacts having open barrels

Faults with crimped contacts are shown in Figures 35a) and 35b); these faults are often caused by:

- inappropriate handling;
- incorrect adjustment of the crimping tool/machine;
- incorrect crimping tool/machine;
- incorrect storage before and after crimping, etc.

Crimped contacts having these faults should be rejected by the quality control.

<http://www.china-gauges.com/>

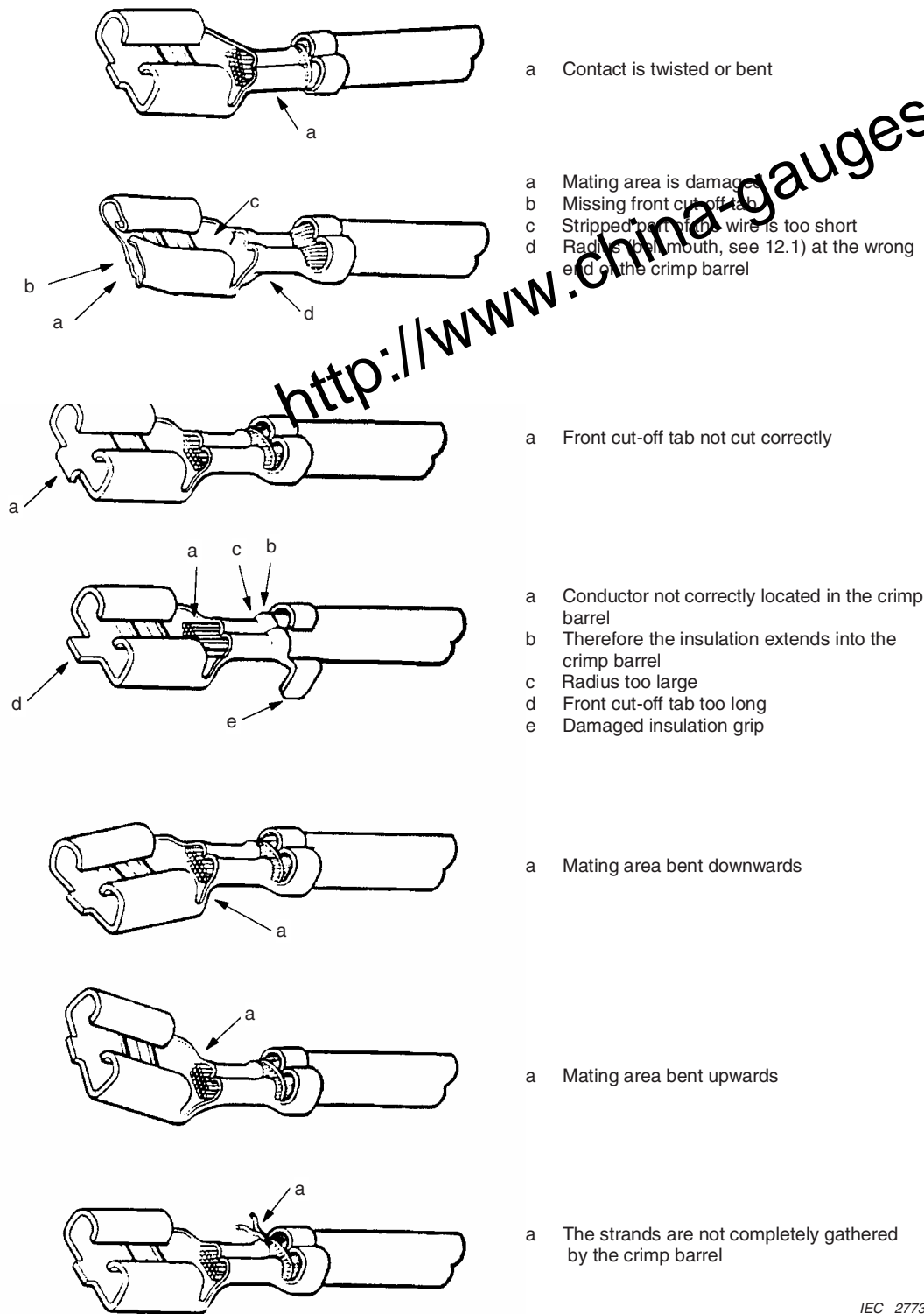

<http://www.china-gauges.com/>

IEC 2773/05

NOTE After crimping the contacts, the wire bundles/cables should be handled carefully.

**Figure 35a) – Examples of faults with crimped contacts –
 End feed contacts (length feed contacts)**

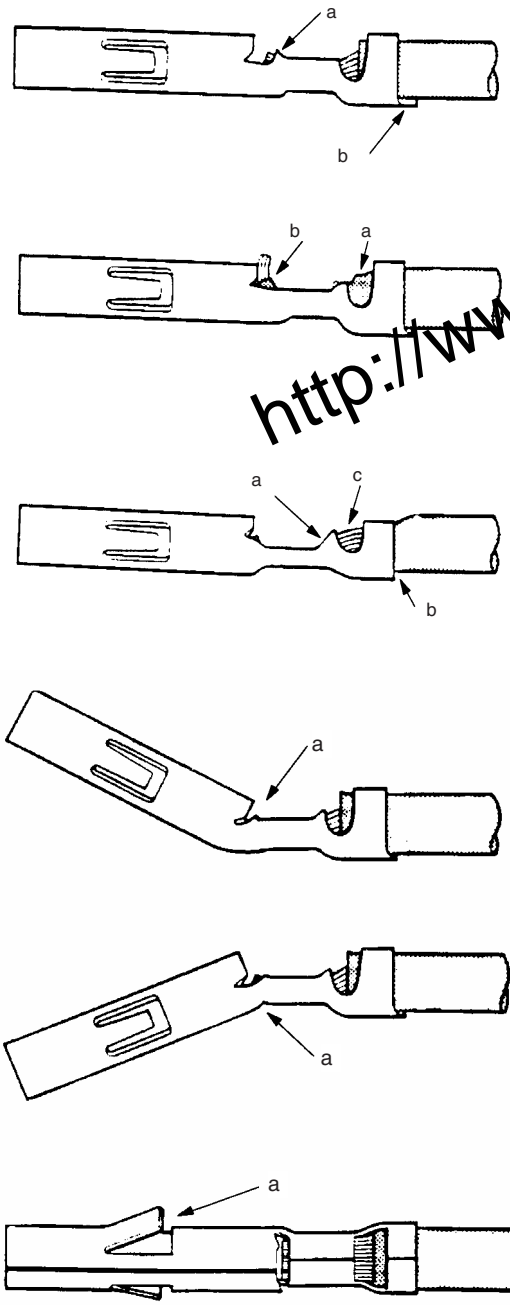

- a Radius on the wrong side of the crimp barrel because of incorrectly mounted crimp indenter
- b Cut-off tab too long due to wrong location of the strip guide plate in the tooling

- a The conductor is not correctly located in the crimp barrel
- b Therefore, the wire end is too long and the insulation extends into the crimp barrel
Cause: missing wire stop or stop in the wrong position

- a Radius too large
- b Missing cut-off tab
- c Conductor not deep enough within the crimp barrel
Cause: wrong location of the strip guide plate

- a Contact bent upwards
Cause: wrong adjustment of the hold-down of the tooling

- a Contact bent downwards
Cause: damaged or wrong tool

- a Contact twisted
Cause: strip feed at the tool is incorrect

IEC 2774/05

NOTE After crimping the contacts, the wire bundles/cables should be handled carefully. Damage to the contacts and in particular deformation of the retention springs during transport and storage should be avoided.

Figure 35b) – Examples of faults with crimped contacts – Side feed contacts

Figure 35 – Examples of faults with crimped contacts

14 General information about crimp type contacts as part of a multipole connector

14.1 Insertion of crimped contacts into the contact cavities of the connector housing

These crimped contacts should be absolutely straight and, without the use of extreme force, inserted in one operation into the contact cavities until a "click" is audible. The correct locking of the contact should be tested by a gentle pull on the wire. Misalignment of the crimped contacts should be avoided because of possible bending of the retention springs, and therefore impaired contact retention in the contact cavity.

Figure 36 shows the correct insertion of a crimped contact into the cavity of the connector housing.

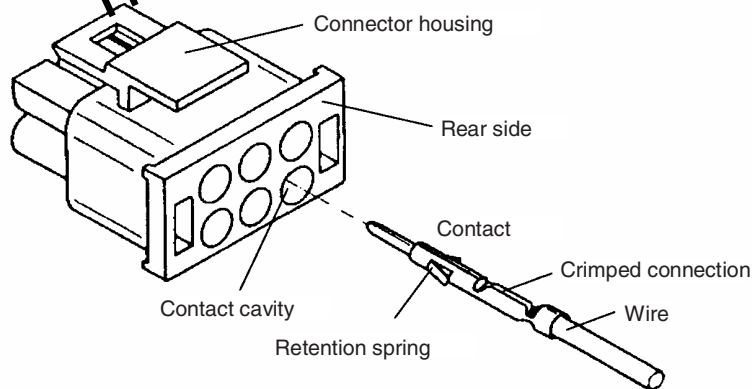

IEC 2775/05

NOTE For wires with small conductor cross-sections ($< 0,35 \text{ mm}^2$) or specific applications, the insertion tools specified by the manufacturer should be used for contact insertion.

Figure 36 – Insertion of crimped contacts into contact cavities

14.2 Removal of inserted contacts

In the case of wrong loading or change of the wiring, inserted contacts can only be removed from the cavity with the contact removal tools specified by the manufacturer.

14.3 Mounting and bending of wire bundles/cables with crimped contacts

Wire bundles/cables with crimped contacts for multipole connectors should not stress the inserted contacts by their own weight, because of the existing danger of inclination of the contacts in the mating area of the connectors. This can be the reason for contact damage during the mating of both connector halves.

Thus, the connectors should have a cable clamp, or the wire bundles/cables should be mounted as shown in Figure 37.

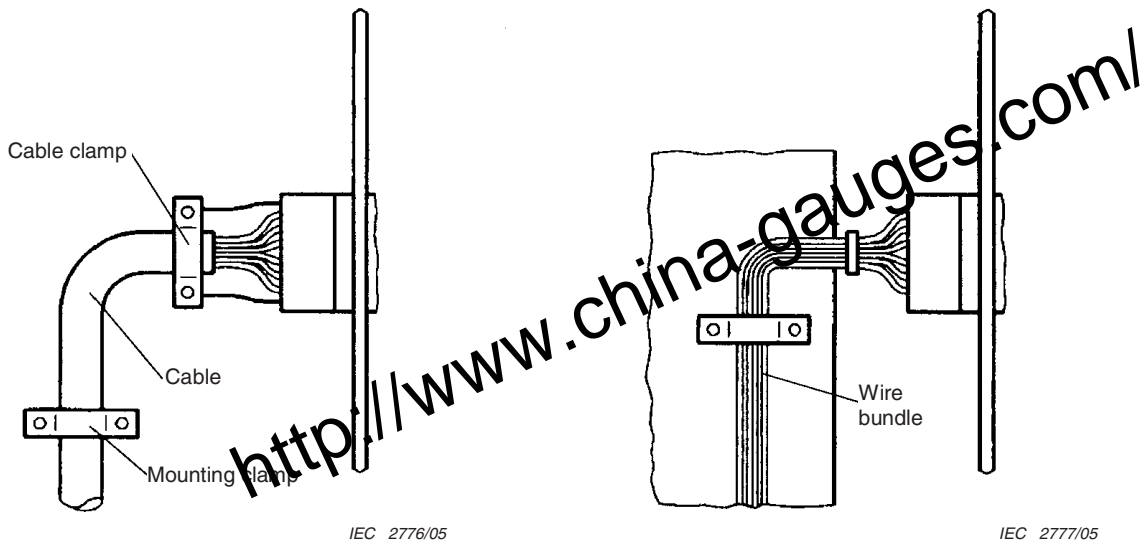

Figure 37 – Mounting of wire bundles/cables with crimped contacts

If wire bundles/cables with crimped contacts have to be bent directly at the termination side of the connectors, no mechanical stress effects should take place in a direction transverse to the engaged contacts.

Figure 38 shows a correct bending and fastening of wire bundles with crimp contacts.

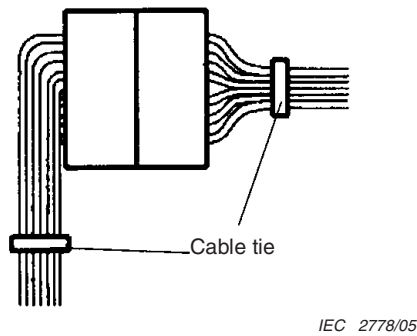

Figure 38 – Bending of wire bundles of connectors

NOTE To avoid unnecessary stress on contacts, wire/wire bundles should not be bent immediately after rear face of a connector housing.

14.4 Mating and unmating of multipole connectors with crimped contacts

To avoid stress on the inserted contacts, the connectors should be mated and unmated in an axial direction, without pushing or pulling the wire bundles/cables. See Figure 39.



Figure 39 Mating and unmating of multipole connectors

15 Final remarks

Attention should be paid to the manufacturer's documentation (detail, product, application specifications, instruction sheets, etc.), which should include information about the number of operations, contact retention, mating and unmating forces, current rating, maximum temperatures, instructions about the crimping tools, etc. Usually, this information is available on request from the contact/connector manufacturer.

Annex ZA
(normative)

**Normative references to international publications
with their corresponding European publications**

The following referenced documents are indispensable for the application of this document. For dated references, only the edition cited applies. For undated references, the latest edition of the referenced document (including any amendments) applies.

NOTE When an international publication has been modified by common modifications, indicated by (mod), the relevant EN/HD applies.

| <u>Publication</u> | <u>Year</u> | <u>Title</u> | <u>EN/HD</u> | <u>Year</u> |
|--|----------------------|--|------------------------------|-------------|
| IEC 60050-581 | 1978 | International Electrotechnical Vocabulary (IEV) Chapter 581: Electromechanical components for electronic equipment | - | - |
| IEC 60068-1 + corr. October + A1 | 1988 1988 1992 | Environmental testing Part 1: General and guidance | EN 60068-1 | 1994 |
| IEC 60189-3 | 1988 | Low-frequency cables and wires with PVC insulation and PVC sheath Part 3: Equipment wires with solid or stranded conductor, PVC insulated, in singles, pairs and triples | - | - |
| IEC 60512 | Series | Connectors for electronic equipment - Tests and measurements | EN 60512 | Series |
| IEC 60512-1-100 | 2001 | Connectors for electronic equipment - Tests and measurements Part 1-100: General - Applicable publications | EN 60512-1-100 ¹⁾ | 2001 |
| IEC 60670 A1 | 1989 1994 | Flat, quick-connect terminations | - | - |
| ISO 6892 | 1998 | Metallic materials - Tensile testing at ambient - temperature | - | - |

¹⁾ EN 60512-1-100 is superseded by EN 60512-1-100:2006, which is based on IEC 60512-1-100:2006.

<http://www.china-gauges.com/>

<http://www.china-gauges.com/>

BSI — British Standards Institution

BSI is the independent national body responsible for preparing British Standards. It presents the UK view on standards in Europe and at the international level. It is incorporated by Royal Charter.

Revisions

British Standards are updated by amendment or revision. Users of British Standards should make sure that they possess the latest amendments or editions.

It is the constant aim of BSI to improve the quality of our products and services. We would be grateful if anyone finding an inaccuracy or ambiguity while using this British Standard would inform the Secretary of the technical committee responsible, the identity of which can be found on the inside front cover. Tel: +44 (0)20 8996 9000. Fax: +44 (0)20 8996 7400.

BSI offers members an individual updating service called PLUS which ensures that subscribers automatically receive the latest editions of standards.

Buying standards

Orders for all BSI, international and foreign standards publications should be addressed to Customer Services. Tel: +44 (0)20 8996 9001. Fax: +44 (0)20 8996 7001. Email: orders@bsi-global.com. Standards are also available from the BSI website at <http://www.bsi-global.com>.

In response to orders for international standards, it is BSI policy to supply the BSI implementation of those that have been published as British Standards, unless otherwise requested.

Information on standards

BSI provides a wide range of information on national, European and international standards through its Library and its Technical Help to Exporters Service. Various BSI electronic information services are also available which give details on all its products and services. Contact the Information Centre. Tel: +44 (0)20 8996 7111. Fax: +44 (0)20 8996 7048. Email: info@bsi-global.com.

Subscribing members of BSI are kept up to date with standards developments and receive substantial discounts on the purchase price of standards. For details of these and other benefits contact Membership Administration. Tel: +44 (0)20 8996 7002. Fax: +44 (0)20 8996 7001. Email: membership@bsi-global.com.

Information regarding online access to British Standards via British Standards Online can be found at <http://www.bsi-global.com/bsonline>.

Further information about BSI is available on the BSI website at <http://www.bsi-global.com>.

Copyright

Copyright subsists in all BSI publications. BSI also holds the copyright, in the UK, of the publications of the international standardization bodies. Except as permitted under the Copyright, Designs and Patents Act 1988 no extract may be reproduced, stored in a retrieval system or transmitted in any form or by any means – electronic, photocopying, recording or otherwise – without prior written permission from BSI.

This does not preclude the free use, in the course of implementing the standard, of necessary details such as symbols, and size, type or grade designations. If these details are to be used for any other purpose than implementation then the prior written permission of BSI must be obtained.

Details and advice can be obtained from the Copyright & Licensing Manager. Tel: +44 (0)20 8996 7070. Fax: +44 (0)20 8996 7553. Email: copyright@bsi-global.com.