

BS EN 60974-6:2016



BSI Standards Publication

Arc welding equipment

Part 6: Limited duty equipment

bsi.

...making excellence a habit.™

National foreword

This British Standard is the UK implementation of EN 60974-6:2016. It is identical to IEC 60974-6:2015. It supersedes BS EN 60974-6:2011 which is withdrawn.

The UK participation in its preparation was entrusted to Technical Committee WEE/6, Electric arc welding equipment.

A list of organizations represented on this committee can be obtained on request to its secretary.

This publication does not purport to include all the necessary provisions of a contract. Users are responsible for its correct application.

© The British Standards Institution 2016.

Published by BSI Standards Limited 2016

ISBN 978 0 580 86281 6

ICS 25.160.30

Compliance with a British Standard cannot confer immunity from legal obligations.

This British Standard was published under the authority of the Standards Policy and Strategy Committee on 31 January 2016.

Amendments/corrigenda issued since publication

Date	Text affected
------	---------------

EUROPEAN STANDARD

EN 60974-6

NORME EUROPÉENNE

EUROPÄISCHE NORM

January 2016

ICS 25.160.30

Supersedes EN 60974-6:2011

English Version

Arc welding equipment - Part 6: Limited duty equipment
(IEC 60974-6:2015)Matériel de soudage à l'arc - Partie 6: Matériel à service
limité
(IEC 60974-6:2015)Lichtbogenschweißeinrichtungen - Teil 6:
Schweißstromquellen mit begrenzter Einschaltdauer
(IEC 60974-6:2015)

This European Standard was approved by CENELEC on 2015-10-27. CENELEC members are bound to comply with the CEN/CENELEC Internal Regulations which stipulate the conditions for giving this European Standard the status of a national standard without any alteration.

Up-to-date lists and bibliographical references concerning such national standards may be obtained on application to the CEN-CENELEC Management Centre or to any CENELEC member.

This European Standard exists in three official versions (English, French, German). A version in any other language made by translation under the responsibility of a CENELEC member into its own language and notified to the CEN-CENELEC Management Centre has the same status as the official versions.

CENELEC members are the national electrotechnical committees of Austria, Belgium, Bulgaria, Croatia, Cyprus, the Czech Republic, Denmark, Estonia, Finland, Former Yugoslav Republic of Macedonia, France, Germany, Greece, Hungary, Iceland, Ireland, Italy, Latvia, Lithuania, Luxembourg, Malta, the Netherlands, Norway, Poland, Portugal, Romania, Slovakia, Slovenia, Spain, Sweden, Switzerland, Turkey and the United Kingdom.



European Committee for Electrotechnical Standardization
Comité Européen de Normalisation Electrotechnique
Europäisches Komitee für Elektrotechnische Normung

CEN-CENELEC Management Centre: Avenue Marnix 17, B-1000 Brussels

European foreword

The text of document 26/572/FDIS, future edition 3 of IEC 60974-6, prepared by IEC/TC 26 "Electric welding" was submitted to the IEC-CENELEC parallel vote and approved by CENELEC as EN 60974-6:2016.

The following dates are fixed:

- latest date by which the document has to be implemented at national level by publication of an identical national standard or by endorsement (dop) 2016-07-27
- latest date by which the national standards conflicting with the document have to be withdrawn (dow) 2018-10-27

This document supersedes EN 60974-6:2011.

Attention is drawn to the possibility that some of the elements of this document may be the subject of patent rights. CENELEC [and/or CEN] shall not be held responsible for identifying any or all such patent rights.

This standard covers the Principle Elements of the Safety Objectives for Electrical Equipment Designed for Use within Certain Voltage Limits (LVD - 2006/95/EC).

This document has been prepared under a mandate given to CENELEC by the European Commission and the European Free Trade Association.

Endorsement notice

The text of the International Standard IEC 60974-6:2015 was approved by CENELEC as a European Standard without any modification.

In the official version, for Bibliography, the following notes have to be added for the standards indicated:

IEC 60085	NOTE	Harmonized as EN 60085.
IEC 60127-1	NOTE	Harmonized as EN 60127-1.
IEC 60269-1	NOTE	Harmonized as EN 60269-1.
IEC 60974	NOTE	Harmonized in EN 60974 series.
IEC 61558-1:2005	NOTE	Harmonized as EN 61558-1:2005 (not modified).

Annex ZA
(normative)

**Normative references to international publications
with their corresponding European publications**

The following documents, in whole or in part, are normatively referenced in this document and are indispensable for its application. For dated references, only the edition cited applies. For undated references, the latest edition of the referenced document (including any amendments) applies.

NOTE 1 When an International Publication has been modified by common modifications, indicated by (mod), the relevant EN/HD applies.

NOTE 2 Up-to-date information on the latest versions of the European Standards listed in this annex is available here: www.cenelec.eu

<u>Publication</u>	<u>Year</u>	<u>Title</u>	<u>EN/HD</u>	<u>Year</u>
IEC 60529	-	Degrees of protection provided by enclosures (IP Code)	EN 60529	-
IEC 60974-1	2012	Arc welding equipment - Part 1: Welding power sources	EN 60974-1	2012
IEC 60974-5	2013	Arc welding equipment - Part 5: Wire feeders	EN 60974-5	2013
IEC 60974-7	2013	Arc welding equipment - Part 7: Torches	EN 60974-7	2013
IEC 60974-10	-	Arc welding equipment - Part 10: Electromagnetic compatibility (EMC) requirements	EN 60974-10	-
IEC 60974-11	-	Arc welding equipment - Part 11: Electrode holders	EN 60974-11	-
IEC 61032	1997	Protection of persons and equipment by enclosures - Probes for verification	EN 61032	1998
ISO 2503	-	Gas welding equipment - Pressure regulators and pressure regulators with flow-metering devices for gas cylinders used in welding, cutting and allied processes up to 300 bar (30 MPa)	EN ISO 2503	-

CONTENTS

FOREWORD.....	
1 Scope.....	8
2 Normative references	8
3 Terms and definitions	9
4 Environmental conditions.....	10
5 Tests.....	10
5.1 Test conditions	10
5.2 Measuring instruments.....	10
5.3 Conformity of components.....	10
5.4 Type tests.....	10
5.5 Routine tests.....	11
6 Protection against electric shock	11
6.1 Insulation.....	11
6.1.1 General	11
6.1.2 Clearances	11
6.1.3 Creepage distances.....	11
6.1.4 Insulation resistance.....	12
6.1.5 Dielectric strength.....	12
6.2 Protection against electric shock in normal service (direct contact).....	12
6.2.1 Protection provided by the enclosure	12
6.2.2 Capacitors	12
6.2.3 Automatic discharge of supply circuit capacitors	13
6.3 Protection against electric shock in case of a fault condition (indirect contact)	13
6.3.1 Protective provisions	13
6.3.2 Isolation between windings of the supply circuit and the welding circuit.....	13
6.3.3 Internal conductors and connections.....	13
6.3.4 Additional requirements for plasma cutting systems.....	13
6.3.5 Movable coils and cores	13
6.3.6 Touch current in fault condition.....	13
7 Thermal requirements.....	15
7.1 Devices for thermal protection and thermal control.....	15
7.2 Heating test	15
7.2.1 Test conditions	15
7.2.2 Tolerances of the test parameters	15
7.2.3 Rated maximum welding current.....	15
7.2.4 Calculation	16
7.3 Temperature measurement	16
7.3.1 Measurement condition.....	16
7.3.2 Surface temperature sensor.....	16
7.3.3 Resistance	16
7.3.4 Embedded temperature sensor	16
7.3.5 Determination of the ambient air temperature	16
7.3.6 Recording of temperatures	17
7.4 Limits of temperature	17
7.4.1 Windings, commutators and slip-rings.....	17

7.4.2	External surfaces.....	17
7.4.3	Other components.....	17
7.5	Loading test.....	17
7.6	Commutators and slip-rings.....	18
8	Thermal control device.....	18
8.1	Construction.....	18
8.2	Location.....	18
8.3	Operation.....	18
8.4	Resetting.....	18
8.5	Operating capacity.....	19
8.6	Indication.....	19
9	Thermal protection.....	19
9.1	Construction.....	19
9.2	Location.....	19
9.3	Operation.....	19
10	Abnormal operation.....	20
10.1	General requirements.....	20
10.2	Stalled fan test.....	20
10.3	Short circuit test.....	20
11	Connection to the input supply network.....	21
11.1	Input supply.....	21
11.1.1	Supply voltage.....	21
11.1.2	Supply current.....	21
11.1.3	Engine driven welding power source.....	21
11.2	Multi supply voltage.....	21
11.3	Means of connection to the supply circuit.....	21
11.4	Supply circuit terminals.....	21
11.5	Cable anchorage.....	22
11.6	Inlet openings.....	22
11.7	Supply circuit on/off switching device.....	22
11.8	Supply cables.....	22
11.9	Supply coupling device (attachment plug).....	22
12	Output.....	22
12.1	Rated no-load voltage.....	22
12.1.1	Rated no-load voltage for arc welding power source.....	22
12.1.2	Rated no-load voltage for plasma cutting power source.....	23
12.1.3	Additional requirements.....	23
12.1.4	Measuring circuit.....	24
12.2	Type test values of the conventional load voltage.....	25
12.2.1	Manual metal arc welding with covered electrodes.....	25
12.2.2	Tungsten inert gas arc welding.....	25
12.2.3	Metal inert/active gas and flux cored arc welding.....	25
12.2.4	Plasma cutting.....	25
12.2.5	Additional requirements.....	25
12.3	Mechanical switching devices used to adjust output.....	26
12.4	Welding circuit connections.....	26
12.4.1	Protection against unintentional contact.....	26
12.4.2	Location of coupling devices.....	26

12.4.3	Outlet openings	26
12.4.4	Marking	26
12.4.5	Connections for plasma cutting torches	26
12.5	Power supply to external devices	26
12.6	Auxiliary power output.....	26
12.7	Welding cables	26
13	Control circuits	26
14	Hazard reducing device	26
15	Mechanical provisions	27
15.1	General requirements	27
15.2	Enclosure	27
15.2.1	Enclosure materials.....	27
15.2.2	Enclosure strength.....	27
15.3	Handling means.....	27
15.4	Drop withstand.....	27
15.5	Tilting stability.....	27
16	Auxiliaries.....	27
16.1	General.....	27
16.2	Wire feeder	27
16.2.1	General	27
16.2.2	Test conditions	27
16.2.3	Thermal requirements.....	28
16.2.4	Protection against unintentional contact.....	28
16.3	Torch	28
16.3.1	General	28
16.3.2	Test conditions	28
16.3.3	Thermal requirements.....	28
16.4	Electrode holder.....	28
16.5	Pressure regulator	28
17	Rating plate	28
17.1	General requirements	28
17.2	Description	28
17.3	Contents	29
17.4	Tolerances.....	31
18	Adjustment of the output.....	32
19	Instructions and markings.....	32
19.1	Instructions	32
19.1.1	General	32
19.1.2	Instruction manual	32
19.1.3	Safety instructions	32
19.2	Markings.....	33
Annex A (informative)	Test probes	35
Annex B (informative)	Examples of rating plates	36
Annex C (informative)	Symbols-only precautionary label.....	37
Bibliography.....		38
Figure 1 – Measurement of touch current in fault condition		14

Figure 2 – Measuring network for weighted touch current	14
Figure 3 – Measurement of r.m.s values	24
Figure 4 – Measurement of peak values.....	25
Figure 5 – Principle of the rating plate	29
Figure A.1 – Test probe 12 of IEC 61032	35
Figure A.2 – Test probe 13 of IEC 61032	35
Figure B.1 – Rating plate	36
Figure C.1 – Example of precautionary label for engine driven manual metal arc welding power source	37
Table 1 – Temperature limits according to the class of insulation.....	17
Table 2 – Maximum temperature limits.....	20
Table 3 – Summary of rated no-load voltages	24
Table 4 – Hazard reducing device requirements for plasma cutting power source	27

INTERNATIONAL ELECTROTECHNICAL COMMISSION

ARC WELDING EQUIPMENT –

Part 6: Limited duty equipment

FOREWORD

- 1) The International Electrotechnical Commission (IEC) is a worldwide organization for standardization comprising all national electrotechnical committees (IEC National Committees). The object of IEC is to promote international co-operation on all questions concerning standardization in the electrical and electronic fields. To this end and in addition to other activities, IEC publishes International Standards, Technical Specifications, Technical Reports, Publicly Available Specifications (PAS) and Guides (hereafter referred to as "IEC Publication(s)"). Their preparation is entrusted to technical committees; any IEC National Committee interested in the subject dealt with may participate in this preparatory work. International, governmental and non-governmental organizations liaising with the IEC also participate in this preparation. IEC collaborates closely with the International Organization for Standardization (ISO) in accordance with conditions determined by agreement between the two organizations.
- 2) The formal decisions or agreements of IEC on technical matters express, as nearly as possible, an international consensus of opinion on the relevant subjects since each technical committee has representation from all interested IEC National Committees.
- 3) IEC Publications have the form of recommendations for international use and are accepted by IEC National Committees in that sense. While all reasonable efforts are made to ensure that the technical content of IEC Publications is accurate, IEC cannot be held responsible for the way in which they are used or for any misinterpretation by any end user.
- 4) In order to promote international uniformity, IEC National Committees undertake to apply IEC Publications transparently to the maximum extent possible in their national and regional publications. Any divergence between any IEC Publication and the corresponding national or regional publication shall be clearly indicated in the latter.
- 5) IEC itself does not provide any attestation of conformity. Independent certification bodies provide conformity assessment services and, in some areas, access to IEC marks of conformity. IEC is not responsible for any services carried out by independent certification bodies.
- 6) All users should ensure that they have the latest edition of this publication.
- 7) No liability shall attach to IEC or its directors, employees, servants or agents including individual experts and members of its technical committees and IEC National Committees for any personal injury, property damage or other damage of any nature whatsoever, whether direct or indirect, or for costs (including legal fees) and expenses arising out of the publication, use of, or reliance upon, this IEC Publication or any other IEC Publications.
- 8) Attention is drawn to the Normative references cited in this publication. Use of the referenced publications is indispensable for the correct application of this publication.
- 9) Attention is drawn to the possibility that some of the elements of this IEC Publication may be the subject of patent rights. IEC shall not be held responsible for identifying any or all such patent rights.

International Standard IEC 60974-6 has been prepared by IEC technical committee 26: Electric welding.

This third edition cancels and replaces the second edition published in 2010. It constitutes a technical revision.

The main significant technical changes with respect to the previous edition are the following:

- modified measurement conditions (see 7.3.1);
- improved values for temperature limits according to the class of insulation (see Table 1);
- improved maximum temperature limits (see Table 2);
- deleted overload test.

The text of this standard is based on the following documents:

FDIS	Report on voting
26/572/FDIS	26/581/RVD

Full information on the voting for the approval of this standard can be found in the report on voting indicated in the above table.

This publication has been drafted in accordance with the ISO/IEC Directives, Part 2.

This standard is to be used in conjunction with IEC 60974-1:2012.

In this standard, the following print types are used:

- *conformity statements*, in *italic type*.

A list of all the parts in the IEC 60974 series, published under the general title *Arc welding equipment*, can be found on the IEC website.

The committee has decided that the contents of this publication will remain unchanged until the stability date indicated on the IEC web site under "<http://webstore.iec.ch>" in the data related to the specific publication. At this date, the publication will be

- reconfirmed,
- withdrawn,
- replaced by a revised edition, or
- amended.

IMPORTANT – The “colour inside” logo on the cover page of this publication indicates that it contains colours which are considered to be useful for the correct understanding of its contents. Users should therefore print this publication using a colour printer.

ARC WELDING EQUIPMENT –

Part 6: Limited duty equipment

1 Scope

This part of IEC 60974 specifies safety and performance requirements applicable to limited duty arc welding and cutting power sources and auxiliaries designed for use by laymen. Electrically powered equipment is intended to be connected to the single phase public low-voltage supply system. Engine driven power sources cannot exceed output power of 7,5 kVA.

NOTE 1 This equipment is typically used by non-professionals in residential areas.

This part of IEC 60974 is not applicable to arc welding and cutting power sources that require for operation:

- arc striking and stabilizing devices;
- liquid cooling systems;
- gas consoles;
- three-phase input supply;

and which are intended for industrial and professional use only.

This part of IEC 60974 is not applicable to arc welding and cutting power sources and ancillary equipment used in:

- mechanically guided applications;
- submerged arc welding process;
- plasma gouging process;
- plasma welding process;

that are covered by other parts of IEC 60974.

NOTE 2 Power sources, wire feeders, torches and electrode holders designed for industrial and professional use are respectively covered by IEC 60974-1, IEC 60974-5, IEC 60974-7 and IEC 60974-11.

NOTE 3 This part of IEC 60974 does not specify electromagnetic compatibility (EMC) requirements that are given in IEC 60974-10.

2 Normative references

The following documents, in whole or in part, are normatively referenced in this document and are indispensable for its application. For dated references, only the edition cited applies. For undated references, the latest edition of the referenced document (including any amendments) applies.

IEC 60529, *Degrees of protection provided by enclosures (IP Code)*

IEC 60974-1:2012, *Arc welding equipment – Part 1: Welding power sources*

IEC 60974-5:2013, *Arc welding equipment – Part 5: Wire feeders*

IEC 60974-7:2013, *Arc welding equipment – Part 7: Torches*

IEC 60974-10, *Arc welding equipment – Part 10: Electromagnetic compatibility (EMC) requirements*

IEC 60974-11, *Arc welding equipment – Part 11: Electrode holders*

IEC 61032:1997, *Protection of persons and equipment by enclosure – Probes for verification*

ISO 2503, *Gas welding equipment – Pressure regulators and pressure regulators with flow-metering devices for gas cylinders used in welding, cutting and allied processes up to 300 bar (30 MPa)*

3 Terms and definitions

For the purposes of this document, the terms and definitions given in IEC 60974-1, as well as the following apply:

3.1

touch current

electric current passing through a human body or through an animal body when it touches one or more accessible parts of an installation or equipment

[SOURCE: IEC 60050-195:1990/AMD 1:1999, 195-05-21]

3.2

limited duty welding power source

power source intended for use by a layman

3.3

layman

operator who does not weld in the performance of his profession and has little or no formal instruction in arc welding

3.4

effective supply current

$I_{1\text{eff}}$

value of the effective input current, calculated from the rated maximum supply current ($I_{1\text{max}}$ in A), the supply current at no-load (I_0 in A) and the rated maximum welding time in intermittent mode ($\sum t_{\text{ON}}$ in s) at the rated maximum welding current during an uninterrupted time of one hour by the formula:

$$I_{1\text{eff}} = \sqrt{I_{1\text{max}}^2 \times \frac{\sum t_{\text{ON}}}{3\,600} + I_0^2 \times \left(1 - \frac{\sum t_{\text{ON}}}{3\,600}\right)}$$

3.5

ON time

t_{ON}

period of welding operation as allowed by the thermal control device of the welding power source

3.6

OFF time

t_{OFF}

period of non-welding operation as imposed by the thermal control device of the welding power source

3.7**rated welding time in 1 h**

$$\sum t_{\text{ON}}$$

summation of the ON times (t_{ON}) at the rated maximum welding current in a 60 min period following the first OFF time (t_{OFF})

3.8**rated continuous welding time**

$$t_{\text{ON(max)}}$$

ON time (t_{ON}) at the rated maximum welding current before the first OFF time (t_{OFF})

4 Environmental conditions

Welding power sources and auxiliaries shall be capable of operating when the following environmental conditions prevail:

- a) range of ambient air temperature:
 - during operation: -10 °C to $+40\text{ °C}$;
- b) relative humidity of the air:
 - up to 50 % at 40 °C ;
 - up to 90 % at 20 °C ;
- c) ambient air, free from abnormal amounts of dust, acids, corrosive gases or substances etc. other than those generated by the welding process;
- d) altitude above sea level up to 1 000 m;
- e) base of the welding power source inclined up to 10° .

Welding power sources and auxiliaries shall withstand storage and transport at an ambient air temperature of -20 °C to $+55\text{ °C}$ without any damage to function and performance.

Welding power source and auxiliaries shall be capable of delivering the rated continuous welding time and the rated welding time in 1 h at an ambient temperature of 20 °C .

5 Tests**5.1 Test conditions**

The thermal tests shall be carried out at an ambient temperature of 20 °C , see tolerances in 7.2.2 e).

Other tests shall be carried out at an ambient air temperature between 10 °C and 40 °C .

5.2 Measuring instruments

See 5.2 of IEC 60974-1:2012.

5.3 Conformity of components

See 5.3 of IEC 60974-1:2012.

5.4 Type tests

Unless otherwise specified, the tests in this standard are type tests.

The welding power source shall be tested with any ancillary equipment fitted that could affect the test results.

All type tests shall be carried out on the same welding power source except where it is specified that a test may be carried out on another welding power source.

As a condition of conformity the type tests given below shall be carried out in the following sequence with no drying time between f), g) and h):

- a) general visual inspection, see 3.7 of IEC 60974-1:2012;
- b) insulation resistance, see 6.1.4 (preliminary check);
- c) enclosure, see 15.2;
- d) handling means, see 15.3;
- e) drop withstand, see 15.4;
- f) protection provided by the enclosure, see 6.2.1;
- g) insulation resistance, see 6.1.4;
- h) dielectric strength, see 6.1.5;
- i) visual inspection, see 3.7 of IEC 60974-1:2012.

The other tests included in this standard and not listed in 5.4 shall be carried out in any convenient sequence.

5.5 Routine tests

All routine tests shall be carried out on each welding power source. The following sequence is recommended:

- a) visual inspection, see 3.7 of IEC 60974-1:2012;
- b) continuity of the protective circuit, see 10.5.1 of IEC 60974-1:2012;
- c) dielectric strength, see 6.1.5;
- d) no-load voltage
 - 1) rated no-load voltage, see 12.1; or
 - 2) for plasma cutting power source, rated reduced no-load voltage, see 13.2.1 of IEC 60974-1:2012;
- e) test to ensure rated minimum and maximum output values in accordance with 15.4 b) and 15.4 c) of IEC 60974-1:2012. The manufacturer may select conventional load, short circuit load or other test conditions.

NOTE In short circuit and other test condition, the output values can differ from conventional load values.

6 Protection against electric shock

6.1 Insulation

6.1.1 General

See 6.1.1 of IEC 60974-1:2012.

6.1.2 Clearances

See 6.1.2 of IEC 60974-1:2012.

6.1.3 Creepage distances

See 6.1.3 of IEC 60974-1:2012.

6.1.4 Insulation resistance

See 6.1.4 of IEC 60974-1:2012.

6.1.5 Dielectric strength

See 6.1.5 of IEC 60974-1:2012.

6.2 Protection against electric shock in normal service (direct contact)

6.2.1 Protection provided by the enclosure

6.2.1.1 General

Welding power sources shall have a minimum degree of protection of IP21S using IEC 60529 test procedures and conditions.

Remote controls for welding power sources shall have a minimum degree of protection of IP2X using IEC 60529 test procedures and conditions.

6.2.1.2 Protection against ingress of water

Adequate drainage shall be provided by the enclosure. Retained water shall not interfere with the correct operation of the equipment or impair safety.

Conformity shall be checked as follows:

A welding power source shall be subjected to the appropriate water test without being energized. Immediately after the test, the welding power source shall be moved to a safe environment and subjected to the insulation resistance and dielectric strength tests.

Adequate drainage of the enclosure shall be checked by visual inspection.

6.2.1.3 Side and top enclosure openings

The enclosure shall be such that a 50 mm long test pin cannot be inserted from all sides except the underside to touch:

- a) live parts of the input circuit or
- b) in the case of Class II welding power sources, any metal part which is separated from live parts of the input circuit by basic insulation.

Conformity shall be checked with test probe 12 of IEC 61032:1997 (see Figure A.1).

6.2.1.4 Bottom enclosure openings

The enclosure shall be such that a 15 mm long test pin cannot be inserted from the underside to touch:

- a) live parts of the input circuit and
- b) in the case of Class II welding power sources, any metal part which is separated from live parts of the input circuit by basic insulation.

Conformity shall be checked with test probe 13 of IEC 61032:1997 (see Figure A.2).

6.2.2 Capacitors

See 6.2.2 of IEC 60974-1:2012.

6.2.3 Automatic discharge of supply circuit capacitors

See 6.2.3 of IEC 60974-1:2012.

6.3 Protection against electric shock in case of a fault condition (indirect contact)

6.3.1 Protective provisions

See 6.3.1 of IEC 60974-1:2012.

6.3.2 Isolation between windings of the supply circuit and the welding circuit

See 6.3.2 of IEC 60974-1:2012.

6.3.3 Internal conductors and connections

See 6.3.3 of IEC 60974-1:2012.

6.3.4 Additional requirements for plasma cutting systems

See 6.3.4 of IEC 60974-1:2012.

6.3.5 Movable coils and cores

See 6.3.5 of IEC 60974-1:2012.

6.3.6 Touch current in fault condition

The weighted touch current shall not exceed 7 mA peak in the case of external protective conductor failure or disconnection.

Conformity shall be checked using the measuring circuit as shown in Figure 1 and Figure 2 under the following conditions:

- a) *the welding power source is:*
 - *isolated from the ground plane;*
 - *supplied by the highest rated supply voltage;*
 - *not connected to the protective earth except through measurement components;*
- b) *the output circuit is in the no-load condition;*
- c) *interference suppression capacitors shall not be disconnected.*

NOTE Caution! A qualified person performs this test. The protective conductor is disabled for this test.

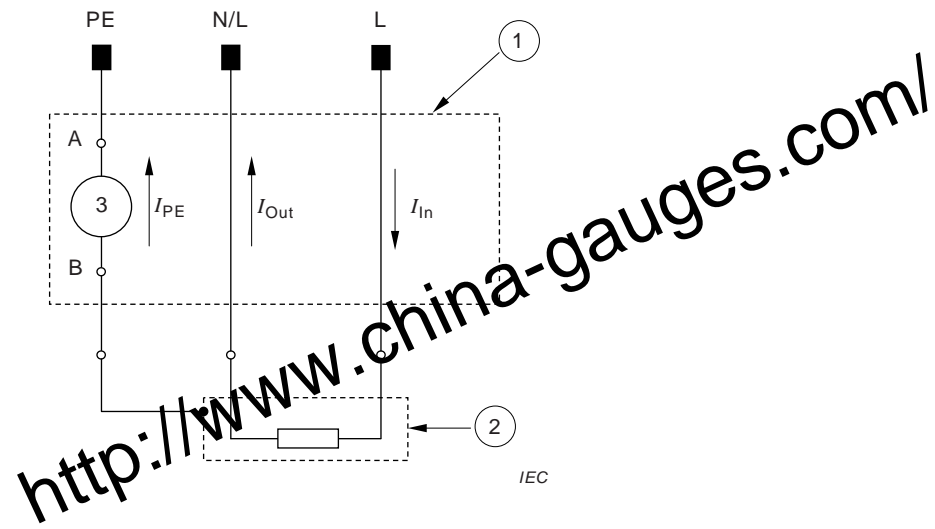

Key

- 1 measuring network
- 2 power source
- 3 circuit diagram of Figure 2
- A, B connection terminals of measuring network
- L line
- N neutral
- PE protective earth

Figure 1 – Measurement of touch current in fault condition

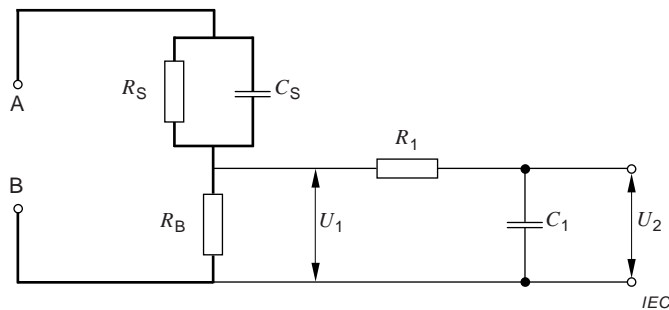

Key

- | | | | |
|-------|----------------|-------|-----------------|
| A, B | test terminals | C_S | 0,22 μ F |
| R_S | 1 500 Ω | R_1 | 10 000 Ω |
| R_B | 500 Ω | C_1 | 0,022 μ F |
| U_1 | r.m.s. voltage | | |

$$\text{weighted touch current (perception/reaction)} = \frac{U_2}{500} \text{ (peak value)}$$

Figure 2 – Measuring network for weighted touch current

7 Thermal requirements

7.1 Devices for thermal protection and thermal control

A welding power source with limited duty shall be fitted with two independent devices, one for thermal protection and one for thermal control.

The thermal control device limits the temperature of its components by reducing or disconnecting the welding current, and is reset automatically and is designed in accordance with Clause 8.

The thermal protection defined in Clause 9 shall be designed to operate if the thermal control device fails.

7.2 Heating test

7.2.1 Test conditions

The welding power source shall be operated at the rated maximum welding current $I_{2\max}$ and conventional load voltage given in 12.2, starting from the cold state.

If it is known that $I_{2\max}$ does not give the maximum heating, then a worst case test shall additionally be made at the setting within the rated range which gives the maximum heating.

When placing the measuring devices, the only access permitted shall be through openings with cover plates, inspection doors or easily removable panels provided by the manufacturer. The ventilation in the test area and the measuring devices used shall not interfere with the normal ventilation of the welding power source or cause abnormal transfer of heat to or from it.

NOTE 1 The maximum temperature of components can be reached at the no-load condition.

NOTE 2 The rated maximum welding current test and the relevant worst case test can follow each other without waiting for the welding power source to return to the ambient air temperature.

7.2.2 Tolerances of the test parameters

During the heating test in accordance with 7.2.3 the following tolerances shall be met:

- a) load voltage: $\begin{matrix} +10 \\ -5 \end{matrix}$ % of the appropriate conventional load voltage;
- b) welding current: $\begin{matrix} +10 \\ -5 \end{matrix}$ % of the appropriate conventional welding current;
- c) supply voltage: ± 5 % of the appropriate rated supply voltage;
- d) engine speed: $\begin{matrix} +10 \\ -5 \end{matrix}$ % of the appropriate rated speed;
- e) temperature: $\begin{matrix} +10 \\ -0 \end{matrix}$ K of the ambient temperature.

7.2.3 Rated maximum welding current

The test sequence for the rated maximum welding current $I_{2\max}$ shall be as follows:

- a) ensure that the welding power source is at thermal equilibrium with the ambient temperature of 20 °C, (see tolerances in 7.2.2 e);
- b) operate the power source at the rated maximum welding current;

- c) record ON time until first operation of the thermal control device: rated continuous welding time t_{ON} (max);
- d) continue the test immediately after the thermal control device resets, for a duration of 60 min;
- e) record ON time for each cycle t_{ON} .

The test has failed if t_{ON} is less than 30 s or t_{ON} (max) is less than 60 s.

7.2.4 Calculation

The following rated value shall be calculated:

- rated welding time in 1 h $\sum t_{ON}$ at the rated maximum welding current see 7.2.3 e);

where t_{ON} is the ON time for each cycle.

The minimum value of $\sum t_{ON}$ shall be 60 s.

7.3 Temperature measurement

7.3.1 Measurement condition

The temperature rise (K) shall be an average of the maximum and the minimum temperature that occurs during t_{ON} of the last cycle for embedded and surface method or at the end of last t_{ON} for resistance method.

The temperature shall be determined as follows:

- a) for windings, by measurement of the resistance, or by surface or embedded temperature sensors;
- b) for other parts, by surface temperature sensors.

Conformity shall be checked by measuring the temperature during the heating test. All temperatures shall not exceed the maximum temperature given in Table 6 of IEC 60974-1:2012.

NOTE 1 The design of limited duty power sources is based on a thermal control device that operates at the maximum allowed temperature as defined by the insulation class.

NOTE 2 The surface temperature sensor method is not preferred.

NOTE 3 In the case of windings of low resistance having switch contacts in series with them, the resistance measurement can give misleading results.

7.3.2 Surface temperature sensor

See 7.2.2 of IEC 60974-1:2012.

7.3.3 Resistance

See 7.2.3 of IEC 60974-1:2012.

7.3.4 Embedded temperature sensor

See 7.2.4 of IEC 60974-1:2012.

7.3.5 Determination of the ambient air temperature

See 7.2.5 of IEC 60974-1:2012.

7.3.6 Recording of temperatures

See 7.2.6 of IEC 60974-1:2012.

7.4 Limits of temperature

7.4.1 Windings, commutators and slip-rings

The temperature for windings, commutators and slip-rings shall not exceed the operating temperatures given in Table 1 for the class of insulation.

No part shall be allowed to reach any temperature that will damage another part even though that part might conform to the requirements in Table 1.

Table 1 – Temperature limits according to the class of insulation

Class of insulation °C	Maximum temperature °C	Maximum temperature rise			
		K			
		Windings			Commutators and slip-rings
Surface temperature sensor	Resistance	Embedded temperature sensor			
105 (A)	150	55	60	65	60
120 (E)	165	70	75	80	70
130 (B)	175	75	80	90	80
155 (F)	190	95	105	115	90
180 (H)	210	115	125	140	100
200 (N)	230	130	145	160	Not determined
220 (R)	250	150	160	180	

NOTE 1 Surface temperature sensor means that the temperature is measured with non-embedded sensors at the hottest accessible spot of the outer surface of the windings.

NOTE 2 Normally, the temperature at the surface is the lowest. The temperature determined by resistance measurement gives the average between all temperatures occurring in a winding. The highest temperature occurring in the windings (hot spot) can be measured by embedded temperature sensors.

NOTE 3 Other classes of insulation having higher values than those given in Table 1 are available (see IEC 60085).

Conformity shall be checked by measurement in accordance with 7.3.

7.4.2 External surfaces

See 7.3.2 of IEC 60974-1:2012.

7.4.3 Other components

The maximum temperature of other components shall not exceed their rated maximum temperature, in accordance with the relevant standard.

7.5 Loading test

Welding power sources shall withstand repeated load cycles without damage or functional failure.

Conformity shall be checked by the following tests and by establishing that no damage or functional failure to the welding power source occur during the tests.

Starting from the cold state, the welding power source is loaded at the rated maximum welding current until the thermal control device is actuated.

Immediately after reset of the thermal control device, one of the following tests is carried out:

- a) In the case of a drooping characteristic welding power source, the controls are set to provide rated maximum welding current. It is then loaded 60 times with a short circuit having an external resistance between 8 m Ω and 10 m Ω for 2 s, followed by a pause of 3 s.
- b) In the case of a flat characteristic welding power source, it is loaded once with 1,5 times the rated maximum welding current at maximum available load voltage for 15 s.

7.6 Commutators and slip-rings

Commutators, slip-rings and their brushes shall show no evidence of injurious sparking or damage throughout the range of the engine driven power source.

Conformity shall be checked by visual inspection during

- a) *the heating test in accordance with 7.2;*
and
- b) *the loading test in accordance with 7.5.*

8 Thermal control device

8.1 Construction

The thermal control device shall be so constructed that it is not possible:

- a) to change its temperature setting, or
- b) to alter its operation without inflicting obvious physical damage.

Conformity shall be checked by visual inspection.

8.2 Location

The thermal control device shall be permanently located within the welding power source in such a way that the heat transfer is reliable.

Conformity shall be checked by visual inspection.

8.3 Operation

The thermal control device shall prevent the welding power source windings from exceeding the operating temperature limits as specified in Table 1 and without causing any component to exceed its rated temperature within the ambient air temperature range as given in Clause 4 a).

Conformity shall be checked during operation with the power source operated at the output condition of 7.2.1.

8.4 Resetting

The thermal control device shall not reset before the temperature has dropped sufficiently to operate the next cycle with a minimum t_{ON} of 30 s.

Conformity shall be checked by measurement of each t_{ON} during the heating test.

8.5 Operating capacity

The thermal control device shall be capable of breaking either the input current or the welding current 200 times consecutively without failure whilst the welding power source delivers the rated maximum welding current.

Conformity shall be checked by producing the required number of consecutive interruptions of a circuit having the same electrical characteristics, especially current and reactance, as the circuit in which the thermal control device is used.

After this test, the requirements of 8.3 and 8.4 shall be met.

8.6 Indication

Welding power sources shall indicate that the thermal control device has reduced or disconnected the welding power source output. The indicator shall be either a yellow light (or yellow flag within an aperture), or an alphanumeric display showing symbols or words whose meanings are given in the instruction manual.

Conformity shall be checked by visual inspection.

9 Thermal protection

9.1 Construction

The thermal protection shall be so constructed that it is not possible:

- a) to change its temperature setting, or
- b) to alter its operation without inflicting obvious physical damage, or
- c) to reset automatically or manually.

Conformity shall be checked by visual inspection.

9.2 Location

The thermal protection shall be permanently located within the welding power source in such a way that the heat transfer is reliable.

Conformity shall be checked by visual inspection.

9.3 Operation

The thermal protection shall not operate during the heating test.

The thermal protection shall prevent the welding power source from exceeding the maximum temperature limits as specified in Table 2

Table 2 – Maximum temperature limits

	Temperature °C						
	Class 105 (A)	Class 120 (E)	Class 130 (B)	Class 155 (F)	Class 180 (H)	Class 200 (N)	Class 220 (R)
Maximum value during the first hour	200	215	225	240	260	280	300
Maximum value after the first hour	175	190	200	215	235	255	275
Arithmetic mean value after the first hour	150	165	175	190	210	230	250

Conformity shall be checked during the heating test and by the following test.

A welding power source is operated at rated supply voltage or rated load speed of rotation while the thermal control device is disabled and the power source operated at the output condition of 7.2.1. During the test, the thermal protection shall operate before the maximum temperature limits are exceeded.

10 Abnormal operation

10.1 General requirements

A welding power source shall not suffer hazardous electrical breakdown or cause a risk of fire under the abnormal conditions of operation of 10.2 and 10.3. These tests are conducted without regard to temperature attained on any part, or the continued proper functioning of the welding power source. The only criterion is that the welding power source does not become unsafe. These tests may be conducted on other welding power sources.

Welding power sources, protected internally by, for example, a fuse, circuit-breaker or thermal protection, meet this requirement if the internal protection device operates before an unsafe condition occurs.

Conformity shall be checked by the following tests.

- A layer of dry absorbent surgical type cotton is placed under the welding power source, extending beyond each side for a distance of 150 mm.
- Starting from the cold state, the welding power source is operated in accordance with 10.2 and 10.3
- During the test, the welding power source shall not emit flames, molten metal or other materials that ignite the cotton indicator.
- Following the test and within 5 min, the welding power source shall be capable of withstanding a dielectric test in accordance with 6.1.5 b) of IEC 60974-1:2012.

10.2 Stalled fan test

A welding power source, which relies on motor-driven fan(s) for conformity with the tests of Clause 7, is operated at rated supply voltage or rated load speed of rotation for a period of 2 h while the fan motor(s) is(are) mechanically stalled and the power source operated at the output condition of 7.2.1.

NOTE The intention of this test is to run the power source with the fan stationary to check the safety of both fan and power source.

10.3 Short circuit test

See 9.3 of IEC 60974-1:2012.

11 Connection to the input supply network

11.1 Input supply

11.1.1 Supply voltage

Welding power sources shall be capable of operating at the rated supply voltage $\pm 10\%$. This may give deviations from the rated values.

Conformity shall be checked by operation.

11.1.2 Supply current

Supply current shall be measured by an r.m.s. meter with a minimum crest factor of 3 and calculation.

Conformity shall be checked by operation.

NOTE The measurement can be affected by the impedance of the supply circuit (see Annex G of IEC 60974-1:2012).

11.1.3 Engine driven welding power source

In the case of engine powered rotating welding power source, the engine shall be capable of tolerating load variations between maximum load and no-load without adversely affecting the welding performance of the generator.

Conformity shall be checked by operation.

11.2 Multi supply voltage

Welding power sources which are designed to operate from different supply voltages shall be fitted with:

- a) two supply cables, each fitted with a different plug, and a selector switch which ensures that the pins of the plug not in use cannot become live;
- b) a system to automatically configure the welding power source in accordance with the supply voltage.

Conformity shall be checked by operation.

In the case a), a selector switch is additionally tested in accordance with 11.7.

11.3 Means of connection to the supply circuit

Acceptable means of connection to the supply circuit are one of the following:

- a) a flexible input supply cable attached to the welding power source;
- b) appliance inlets fitted to the welding power source and a flexible input supply cable.

The flexible input supply cable shall be in accordance with 11.8 and fitted with a plug in accordance with 11.9.

Conformity shall be checked by visual inspection.

11.4 Supply circuit terminals

See 10.4 and 10.5 of IEC 60974-1:2012.

11.5 Cable anchorage

See 10.6 of IEC 60974-1:2012.

11.6 Inlet openings

See 10.7 of IEC 60974-1:2012.

11.7 Supply circuit on/off switching device

Welding power sources shall be fitted with a supply circuit on/off switching device. The supply circuit on/off switching device shall be in accordance with 10.8 of IEC 60974-1:2012.

11.8 Supply cables

Supply cables shall:

- a) be suitable for the application and meet national and local regulations;
- b) be dimensioned in accordance with the maximum effective supply current $I_{1\text{eff}}$; and
- c) have a length of at least 2 m as measured from the exit point of the enclosure.

Conformity shall be checked by visual inspection and measurement.

NOTE Example or local regulations are given in Bibliography, e.g. HD 22.1 S4, Electrical code NFPA 70 (SO, ST, STO, SJ, SJO, SJT, SJTO or other extra hard usage cable) or CSA C22.1. PVC insulation has been proved not suitable for the application.

11.9 Supply coupling device (attachment plug)

The current rating of a supply coupling device shall be not less than:

- a) the current rating of the fuse required to comply with the short circuit test specified in 10.3;
- b) the maximum effective supply current $I_{1\text{eff}}$.

For 125 V input supply networks, the current rating shall, additionally, not be less than 70 % of the rated maximum supply current for equipment.

Conformity shall be checked by visual inspection, measurement and calculation.

12 Output

12.1 Rated no-load voltage

12.1.1 Rated no-load voltage for arc welding power source

The rated no-load voltage shall not exceed:

- a) d.c. 113 V peak;
- b) a.c. 68 V peak and 48 V r.m.s.

A welding power source that complies with the reduced no-load voltage limits within 200 ms:

- a) d.c. 60 V peak;
- b) a.c. 50 V peak and 35 V r.m.s;

may be marked with symbol 84 of Annex L of IEC 60974-1:2012.

A welding power source that does not comply with the reduced no-load voltage limits within 200 ms, shall not be marked with symbol 84 of Annex L of IEC 60974-1:2012. This welding power source shall be clearly and indelibly marked on or near the front panel or near the ON/OFF switching device with the symbol IEC 60417-6042 that signifies “Caution!: Risk of electric shock”:



NOTE If the arc welding power source is fitted with a voltage reducing device, manufacturer takes into consideration lower additional no-load limit value as far as applicable for the welding process.

Conformity shall be checked by measurement in accordance with 12.1.3.

12.1.2 Rated no-load voltage for plasma cutting power source

The rated no-load voltage shall not exceed 350 V peak d.c.

Conformity shall be checked by measurement in accordance with 12.1.3, by operation and by visual inspection, except that the series combination of the 200 Ω fixed and 5 k Ω variable resistors may be replaced by a fixed resistance of 5 k Ω .

A rated no-load voltage exceeding 113 V peak d.c. may only be used if the following requirements are fulfilled.

- a) The arc striking sequence shall only start when the plasma tip of the torch is in contact with the workpiece, trigger is pulled and cutting circuit impedance is lower than 200 Ω .
- b) These power sources with their corresponding torches shall prevent the output of no-load voltage if the torch is disassembled or disconnected from the power source.
- c) The voltage between the electrode of the torch and the workpiece shall be less than 68 V peak not later than 2 s after the control circuit is opened (e.g. trigger) or cutting circuit impedance exceeds 200 Ω .
- d) The voltage between the plasma tip of the torch and the workpiece shall not exceed 68 V peak not later than 0,3 s after cutting circuit impedance exceeds 200 Ω .

Conformity shall be checked by measurement by meter or oscilloscope in parallel with 5 k Ω minimum resistance.

12.1.3 Additional requirements

The rated no-load voltage at all possible settings shall not exceed the values given in 12.1.1 to 12.1.2, summarized in Table 3.

Table 3 – Summary of rated no-load voltages

Subclause	Power source	Rated no-load voltage
12.1.1	Arc welding	With risk of electric shock symbol: d.c. 113 V peak a.c. 68 V peak and 48 V r.m.s. Without risk of electric shock symbol: Reduced within 200 ms to d.c. 60 V peak a.c. 50 V peak and a.c. 35 V r.m.s
12.1.2	Plasma cutting	With risk of electric shock symbol: d.c. 50 V peak

Welding power sources, which are electronically controlled, shall be

- a) designed to ensure that the output voltages given in Table 3 cannot be exceeded should any fault occur in an electronic circuit
or
- b) fitted with a protection system, which switches off the voltage at the output terminals within 0,3 s and shall not be reset automatically.

If the no-load voltage is higher than the values given in 12.1.1, the plasma cutting power source shall be fitted with a hazard reducing device in accordance with Clause 14.

A rectifier type d.c. welding power source shall be so constructed that in case of a rectifier failure (e.g. open circuit, short circuit or a phase failure), the allowable values cannot be exceeded.

Conformity shall be checked by measurement and by analysis of the circuit and/or by failure simulation.

12.1.4 Measuring circuit

For measuring r.m.s values, a true r.m.s. meter with a resistance of the external welding circuit of 5 k Ω with a maximum tolerance of $\pm 5\%$ as shown in Figure 3 shall be used.

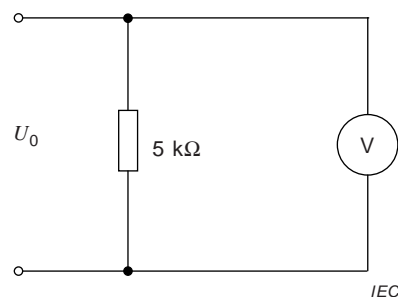

Key

- U_0 no-load voltage
V r.m.s. voltmeter

Figure 3 – Measurement of r.m.s values

To obtain reproducible measurements of peak values, omitting impulses which are not dangerous, a circuit as shown in Figure 4 shall be used.

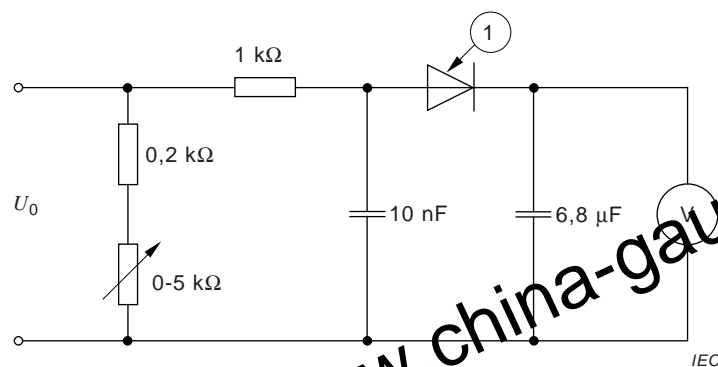
**Key**

1 Diode 1N4007 or similar

Figure 4 – Measurement of peak values

The voltmeter shall indicate mean values. The measurement range chosen shall be as near as possible to the actual value of the no-load voltage. The voltmeter shall have an internal resistance of at least 1 MΩ.

The tolerance of the component values in the measurement circuit shall not exceed $\pm 5\%$.

For the type test, the rheostat is varied from 0 Ω to 5 kΩ in order to obtain the highest peak value of the voltage measured with these loads of 200 Ω to 5,2 kΩ. This measurement is repeated with the two connections to the measuring apparatus reversed.

The rheostat resistance and connection that produces the highest value of the voltage may be determined during the type test. This resistance and lead polarity may be used for the routine test.

12.2 Type test values of the conventional load voltage**12.2.1 Manual metal arc welding with covered electrodes**

$$U_2 = (18 + 0,04 I_2) \text{ V}$$

12.2.2 Tungsten inert gas arc welding

$$U_2 = (10 + 0,04 I_2) \text{ V}$$

12.2.3 Metal inert/active gas and flux cored arc welding

$$U_2 = (14 + 0,05 I_2) \text{ V}$$

12.2.4 Plasma cutting

$$U_2 = (80 + 0,4 I_2) \text{ V}$$

For plasma cutting using air, the manufacturer may specify the load voltage as determined under typical cutting conditions.

12.2.5 Additional requirements

Throughout its range of adjustment, the welding power sources shall be capable of supplying conventional welding currents (I_2) at conventional load voltages (U_2) in accordance with 12.2.1 to 12.2.4.

Conformity shall be checked by sufficient measurements (see Annex H of IEC 60974-1:2012).

12.3 Mechanical switching devices used to adjust output

See 11.3 of IEC 60974-1:2012, but limiting the test to 3 000 cycles.

12.4 Welding circuit connections

12.4.1 Protection against unintentional contact

See 11.4.1 of IEC 60974-1:2012.

12.4.2 Location of coupling devices

See 11.4.2 of IEC 60974-1:2012.

12.4.3 Outlet openings

See 11.4.3 of IEC 60974-1:2012.

12.4.4 Marking

See 11.4.5 of IEC 60974-1:2012.

12.4.5 Connections for plasma cutting torches

See 11.4.6 of IEC 60974-1:2012.

12.5 Power supply to external devices

See 11.5 of IEC 60974-1:2012.

12.6 Auxiliary power output

Only, engine driven power sources may be fitted with auxiliary power output.

See 11.6 of IEC 60974-1:2012.

12.7 Welding cables

See 11.7 of IEC 60974-1:2012.

13 Control circuits

See Clause 12 of IEC 60974-1:2012.

14 Hazard reducing device

Hazard reducing devices are only applicable to plasma cutting power source with a rated no-load voltage exceeding 113 V. A hazard reducing device shall reduce the electric shock hazard that can originate from no-load voltages exceeding the allowable rated no-load voltage for a given environment.

Requirements for maximum limits are given in Table 4.

**Table 4 – Hazard reducing device requirements
for plasma cutting power source**

Unreduced no load voltage	Reduced no load voltage	Operating time s
Between 350 V and 113 V	113 V	0,3

Conformity of hazard reducing device shall be checked in accordance with Clause 13 of IEC 60974-1:2012, if applicable.

15 Mechanical provisions

15.1 General requirements

See 14.1 of IEC 60974-1:2012.

15.2 Enclosure

15.2.1 Enclosure materials

See 14.2.1 of IEC 60974-1:2012.

15.2.2 Enclosure strength

See 14.2.2 of IEC 60974-1:2012.

15.3 Handling means

See 14.3 of IEC 60974-1:2012.

15.4 Drop withstand

See 14.4 of IEC 60974-1:2012.

15.5 Tilting stability

See 14.5 of IEC 60974-1:2012.

16 Auxiliaries

16.1 General

Auxiliaries used with power sources designed for use by layman shall fulfill the requirement of this standard.

16.2 Wire feeder

16.2.1 General

A wire feeder, either a stand-alone unit or built into the power source, shall comply with the requirements of IEC 60974-5:2013 with the following exceptions:

- 16.2.2 replaces 5.1 of IEC 60974-5:2013;
- 16.2.3 replaces Clause 9 of IEC 60974-5:2013.

16.2.2 Test conditions

Test conditions shall be in accordance with 5.1.

16.2.3 Thermal requirements

Thermal requirements shall be in accordance with Clause 7.

16.2.4 Protection against unintentional contact

A wire feeder shall provide protection against unintentional contact with parts at the welding voltage. Such protection can be achieved by a hinged cover or a protective guard.

Conformity shall be checked by visual inspection.

16.3 Torch

16.3.1 General

A torch shall comply with the requirements in IEC 60974-7:2013 with the following exceptions:

- 16.3.2 replaces Clause 6 of IEC 60974-7:2013;
- 16.3.3 replaces Clause 8 of IEC 60974-7:2013.

16.3.2 Test conditions

Test conditions shall be in accordance with 5.1.

16.3.3 Thermal requirements

Thermal requirements shall be in accordance with 8.3.1, 8.3.2, 8.3.3, 8.3.4 of IEC 60974-7:2013.

16.4 Electrode holder

Only a type A electrode holder in accordance with IEC 60974-11 shall be delivered with the welding power source.

16.5 Pressure regulator

Pressure regulator delivered with the welding power source shall be designed in accordance with ISO 2503.

17 Rating plate

17.1 General requirements

See 15.1 of IEC 60974-1:2012.

17.2 Description

The rating plate shall be divided into sections containing information and data for the

- a) identification;
- b) welding output;
- c) energy input.

The arrangement and sequence of the data shall comply with the principle shown in Figure 5 (for examples, see Annex B).

The dimensions of the rating plate are not specified and may be chosen freely.

It is permissible to separate the above sections from each other and affix them at locations more accessible or convenient for the user.

NOTE Additional information can be given. Further useful information, for example class of insulation, pollution degree or power factor, can be given in technical literature supplied by the manufacturer (see Clause 19).



Key

See 17.3

Figure 5 – Principle of the rating plate

17.3 Contents

The following explanations refer to the numbered boxes shown in Figure 5.

a) Identification



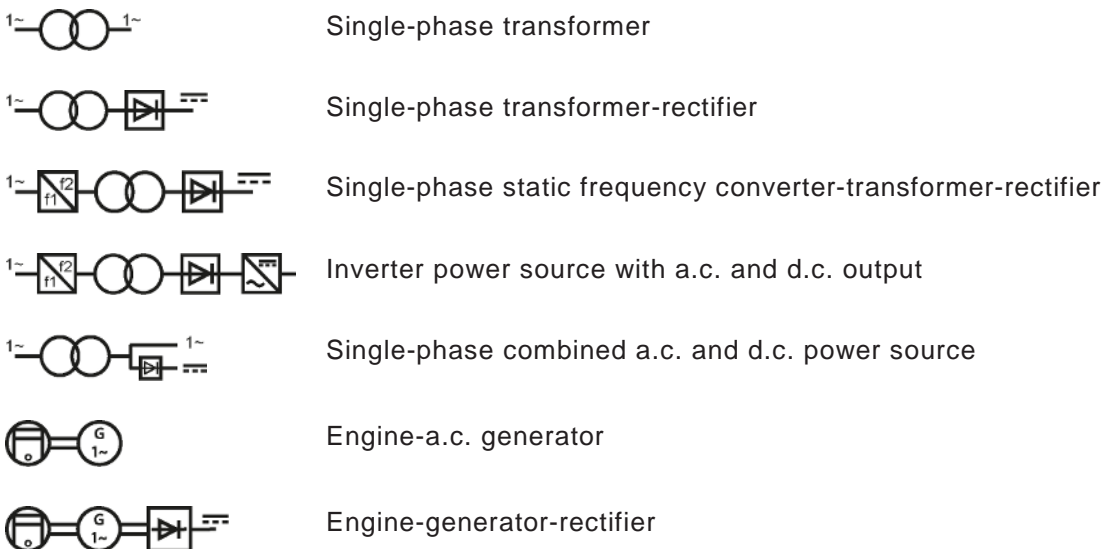





- Box 1 Name and address of the manufacturer or distributor or importer and, optionally, a trade mark and the country of origin, if required
- Box 2 Type (identification) as given by the manufacturer
- Box 3 Traceability of design and manufacturing data, for example serial number
- Box 4 Welding power source symbol (optional) for example



- Box 5 Reference to the standards confirming that the welding power source complies with their requirements

b) Welding output

- Box 6 Welding process symbol e.g.:

	Manual metal arc welding with covered electrodes	(IEC 60974-1:2012, Annex L, symbol 58)
	Tungsten inert-gas welding	(IEC 60974-1:2012, Annex L, symbol 59)
	Metal inert and active gas welding including the use of flux cored wire	(IEC 60974-1:2012, Annex L, symbol 60)
	Selfshielded flux cored arc welding	(IEC 60974-1:2012, Annex L, symbol 61)
	Plasma cutting	(ISO 7000-0479 (2004:01))
Box 7	Welding current symbol e.g.:	
	Direct current	(IEC 60417-5031 (2002:10))
	Alternating current, and additionally the rated frequency in Hertz e.g.: ~50 Hz	(IEC 60417-5032 (2002:10))
	Direct or alternating current at the same output, and additionally the rated frequency in Hertz	(IEC 60417-5033 (2002:10))
Box 8	$U_0..V$	Rated no-load voltage <ul style="list-style-type: none"> a) peak value in case of direct current b) r.m.s. value in case of alternating current
Box 9	$..A/...V$ to... $A/... V$	Range of output, minimum welding current and its corresponding conventional load voltage or less, maximum welding current and its corresponding conventional load voltage or greater.
Box 10	$I_{2max}..A$	Rated maximum welding current at 20 °C ambient temperature
Box 11	$U_2..V$	Values of the conventional load voltage
Box 12		Rated maximum welding time in continuous mode $t_{ON(max)}$ at the rated maximum welding current at an ambient temperature of 20 °C, see 7.2.3 c), expressed in minutes and seconds

Box 13  Rated maximum welding time in intermittent mode $\sum t_{ON}$ at the rated maximum welding current at an ambient temperature of 20 °C during an uninterrupted time of 60 min see 7.2.3 e), expressed in minutes and seconds

c) Energy input

Box 14 Energy input symbol e.g.:

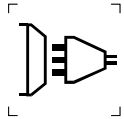

Supply circuit, number of phase (1) symbol for alternating current and the rated frequency (e.g. 50 Hz or 60 Hz) (IEC 60417-5939 (2002:10))



Engine (ISO 7000-0796 (2004:01))

Box 15 $U_1.. V$ Rated supply voltage

Box 16 $I_{1max}.. A$ Rated maximum supply current

Box 17 $I_{1eff}.. A$ Maximum effective supply current

Box 18 a)  "keep away from rain" (ISO 7000-0626 (2004:01))

Box 18 b) IP.. Degree of protection, for example IP21S or IP23S

Box 19  Symbol for class II equipment, if applicable (IEC 60417-5172 (2003:02))

17.4 Tolerances

Manufacturers shall meet rating plate values within the following tolerances by controlling component and manufacturing tolerances:

- a) U_0 rated no-load voltage in V $\pm 5\%$ measured in accordance with 12.1, but in no case shall the values summarized in Table 3 be exceeded;
- b) I_{2min} rated minimum welding current in A;
 U_{2min} minimum conventional load voltage in V;
 The values of b) shall not be greater than those stated on the rating plate.
- c) I_{2max} rated maximum welding current in A;
 U_{2max} maximum conventional load voltage in V;
 The values of c) shall not be less than those stated on the rating plate.
- d) n_0 rated no-load speed of rotation in min^{-1} $\pm 5\%$;
- e) P_{1max} maximum power consumption in kW $\begin{matrix} +10 \\ 0 \end{matrix} \%$;
- f) I_{1max} rated maximum supply current in A $\pm 10\%$.
- g) $t_{ON(max)}$ rated maximum welding time in continuous mode $\pm 10\%$;
 $\sum t_{ON(i)}$ rated maximum welding time in intermittent mode $\pm 10\%$.

Conformity shall be checked by measuring under conventional welding conditions (see 3.17 of IEC 60974-1:2012).

18 Adjustment of the output

See Clause 16 of IEC 60974-1:2012.

19 Instructions and markings

19.1 Instructions

19.1.1 General

Each welding power source shall be delivered with an instruction manual and safety instructions.

19.1.2 Instruction manual

The instruction manual shall include the following (as applicable):

- a) general description;
- b) precautions to be taken with wire feeders, gas cylinders and pressure regulator;
- c) the meaning of indications, markings and graphical symbols;
- d) information on connection to the supply network, fuse and/or circuit-breaker rating;
- e) correct operational use relating to the welding power sources (for example cooling requirements, location, control device, indicators, fuel type);
- f) welding capability, limitations and explanation of thermal control device;
- g) limitations of use: welding power sources are not suitable for use in rain or snow;
- h) how to maintain the welding power source (for example cleaning);
- i) a list of recommended spare parts and consumables;
- j) precautions against toppling over, if the welding power source shall be placed on tilted plane;
- k) type (identification) of auxiliaries that are specified for use with the power source;
- l) warning against the use of a welding power source for pipe thawing;
- m) pressure, flow rate and type of shielding gas;
- n) steps or range of the output current and the corresponding gas as a set of values;
- o) EMC classification in accordance with IEC 60974-10;
- p) the output is rated at an ambient temperature of 20 °C and the welding time may be reduced at higher temperatures.

19.1.3 Safety instructions

The safety instructions shall include the following basic guidelines or equivalent regarding protection against personal hazards for persons in the area.

- a) Risk of electric shock: Electric shock from welding electrode can kill. Do not weld in the rain or snow. Wear dry insulating gloves. Do not touch electrode with bare hands. Do not wear wet or damaged gloves. Protect yourself from electric shock by insulating yourself from workpiece. Do not open the equipment enclosure.
- b) Risk induced by welding fumes: Breathing welding fumes can be hazardous to your health. Keep your head out of the fumes. Use equipment in an open area. Use ventilating fan to remove fumes.

- c) Risk induced by welding sparks: Welding sparks can cause explosion or fire. Keep flammables away from welding. Do not weld near flammables. Welding sparks can cause fires. Have a fire extinguisher nearby and have a watchperson ready to use it. Do not weld on drums or any closed containers.
- d) Risk induced by the arc: Arc rays can burn eyes and injure skin. Wear hat and safety glasses. Use ear protection and button shirt collar. Use welding helmet with correct shade of filter. Wear complete body protection.
- e) Risk induced by electromagnetic fields: Welding current produces electromagnetic field. Do not use with medical implants. Never coil welding cables around your body. Route the welding cables together.

The safety instructions for engine driven power sources shall also include:

- f) Risk induced by exhaust fumes: Engine exhaust gases can kill. Never use inside home, garage or other enclosed spaces, even if doors and windows are open. Only use outside far away from windows, doors and vents.

19.2 Markings

Each welding power source shall be clearly, visibly and indelibly marked with the following combination of symbols or equivalent:



Caution! Read instruction manual



Electric shock from welding electrode can kill



Breathing welding fumes can be hazardous to your health



Welding sparks can cause explosion or fire



Arc rays can burn eyes and injure skin



Electromagnetic field can cause pacemaker malfunction

Each engine driven welding power source shall also be clearly, visibly and indelibly marked with the following combination of symbols or equivalent:



Engine exhaust gases can kill

Each welding power source shall be clearly, visibly and indelibly marked with precautionary labels that contain the safety instructions. Precautionary labels may consist of text only, text and symbols, or symbols only. Where symbols-only precautionary labels are used, it is recommended that these labels follow ISO 17846. An example of symbols-only precautionary label is given in Annex C.

Conformity shall be checked by visual inspection and by testing in accordance with the durability test in 17.1.

<http://www.china-gauges.com/>

Annex A
(informative)

Test probes

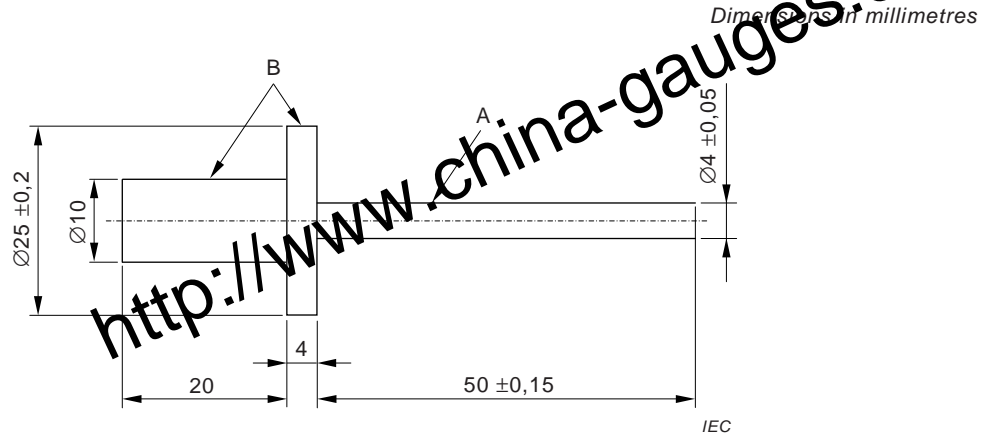

Key

A metal

B insulating material

Figure A.1 – Test probe 12 of IEC 61032

Dimensions in millimetres

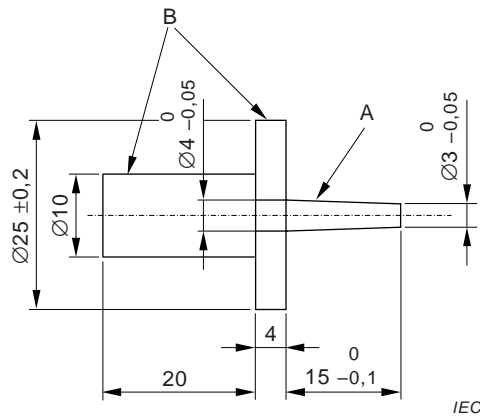

Key

A metal







B insulating material

Figure A.2 – Test probe 13 of IEC 61032

Annex B
(informative)

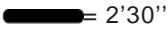
Examples of rating plates

A clearly and indelibly marked rating plate shall be fixed securely and to be printed on each welding power source. See Figure B.1.

1) Manufacturer Address		2) Remark			
2) Type		3) Serial number			
4)		5) IEC 60974-6			
6) 	9) 15 A / 18,6 V at 140 A / 23,6 V				
7) 	8) $U_0 = 48 V$	10) $I_{2max} = 140 A$	11) $U_2 = 23,6 V$	12)  = 2'30"	13)  = 7'36'
14) 	1 ~ 50 Hz	15) $U_1 = 230 V$	16) $I_{1max} = 27 A$	17) $I_{1eff} = 8 A$	
18a) 	18b) IP23S	19) 			

IEC

Figure B.1 – Rating plate

Annex C
(informative)

Symbols-only precautionary label

Precautionary labels shall inform the user on possible hazards, see Figure C.1



IEC

Figure C.1 – Example of precautionary label for engine driven manual metal arc welding power source

Bibliography

- IEC 60050 (all parts), *International Electrotechnical Vocabulary (IEC)* (available at www.electropedia.org)
- IEC 60085, *Electrical insulation – Thermal evaluation and designation*
- IEC 60127-1, *Miniature fuses – Part 1: Definitions for miniature fuses and general requirements for miniature fuse-links*
- IEC 60269-1, *Low-voltage fuses – Part 1: General requirements*
- IEC 60417, *Graphical symbols for use on equipment* (available from: <http://www.graphical-symbols.info/equipment>)
- IEC 60974 (all parts), *Arc welding equipment*
- IEC 61558-1:2005, *Safety of power transformers, power supplies, reactors and similar products – Part 1: General requirements and tests*
- ISO 7000, *Graphical symbols for use on equipment – Index and synopsis*
- ISO 17846, *Welding and allied processes – Health and safety – Wordless precautionary labels for equipment and consumables used in arc welding and cutting*
- CSA C22.1, *Canadian electrical code*
- HD 22.1 S4:2002, *Cables of rated voltages up to and including 450/750 V and having crosslinked insulation – Part 1: General requirements*
- NFPA 70, *National Electrical code*
-

<http://www.china-gauges.com/>

British Standards Institution (BSI)

BSI is the national body responsible for preparing British Standards and other standards-related publications, information and services.

BSI is incorporated by Royal Charter. British Standards and other standardization products are published by BSI Standards Limited.

About us

We bring together business, industry, government, consumers, innovators and others to shape their combined experience and expertise into standards-based solutions.

The knowledge embodied in our standards has been carefully assembled in a dependable format and refined through our open consultation process. Organizations of all sizes and across all sectors choose standards to help them achieve their goals.

Information on standards

We can provide you with the knowledge that your organization needs to succeed. Find out more about British Standards by visiting our website at bsigroup.com/standards or contacting our Customer Services team or Knowledge Centre.

Buying standards

You can buy and download PDF versions of BSI publications, including British and adopted European and international standards, through our website at bsigroup.com/shop, where hard copies can also be purchased.

If you need international and foreign standards from other Standards Development Organizations, hard copies can be ordered from our Customer Services team.

Subscriptions

Our range of subscription services are designed to make using standards easier for you. For further information on our subscription products go to bsigroup.com/subscriptions.

With **British Standards Online (BSOL)** you'll have instant access to over 55,000 British and adopted European and international standards from your desktop. It's available 24/7 and is refreshed daily so you'll always be up to date.

You can keep in touch with standards developments and receive substantial discounts on the purchase price of standards, both in single copy and subscription format, by becoming a **BSI Subscribing Member**.

PLUS is an updating service exclusive to BSI Subscribing Members. You will automatically receive the latest hard copy of your standards when they're revised or replaced.

To find out more about becoming a BSI Subscribing Member and the benefits of membership, please visit bsigroup.com/shop.

With a **Multi-User Network Licence (MUNL)** you are able to host standards publications on your intranet. Licences can cover as few or as many users as you wish. With updates supplied as soon as they're available, you can be sure your documentation is current. For further information, email bsmusales@bsigroup.com.

BSI Group Headquarters

389 Chiswick High Road London W4 4AL UK

Revisions

Our British Standards and other publications are updated by amendment or revision.

We continually improve the quality of our products and services to benefit your business. If you find an inaccuracy or ambiguity within a British Standard or other BSI publication please inform the Knowledge Centre.

Copyright

All the data, software and documentation set out in all British Standards and other BSI publications are the property of and copyrighted by BSI, or some person or entity that owns copyright in the information used (such as the international standardization bodies) and has formally licensed such information to BSI for commercial publication and use. Except as permitted under the Copyright, Designs and Patents Act 1988 no extract may be reproduced, stored in a retrieval system or transmitted in any form or by any means – electronic, photocopying, recording or otherwise – without prior written permission from BSI. Details and advice can be obtained from the Copyright & Licensing Department.

Useful Contacts:

Customer Services

Tel: +44 845 086 9001

Email (orders): orders@bsigroup.com

Email (enquiries): cservices@bsigroup.com

Subscriptions

Tel: +44 845 086 9001

Email: subscriptions@bsigroup.com

Knowledge Centre

Tel: +44 20 8996 7004

Email: knowledgecentre@bsigroup.com

Copyright & Licensing

Tel: +44 20 8996 7070

Email: copyright@bsigroup.com