

BS EN 60974-1:2012



BSI Standards Publication

Arc welding equipment

Part 1: Welding power sources

NO COPYING WITHOUT BSI PERMISSION EXCEPT AS PERMITTED BY COPYRIGHT LAW

raising standards worldwide™



National foreword

This British Standard is the UK implementation of EN 60974-1:2012. It is identical to IEC 60974-1:2012. It supersedes BS EN 60974-1:2005 which is withdrawn.

The UK participation in its preparation was entrusted to Technical Committee WEE/6, Electric arc welding equipment.

A list of organizations represented on this committee can be obtained on request to its secretary.

This publication does not purport to include all the necessary provisions of a contract. Users are responsible for its correct application.

© The British Standards Institution 2012

Published by BSI Standards Limited 2012

ISBN 978 0 580 65872 3

ICS 25.160.30

Compliance with a British Standard cannot confer immunity from legal obligations.

This British Standard was published under the authority of the Standards Policy and Strategy Committee on 31 August 2012.

Amendments issued since publication

Date	Text affected
------	---------------

EUROPEAN STANDARD
NORME EUROPÉENNE
EUROPÄISCHE NORM

EN 60974-1

August 2012

ICS 25.160

Supersedes EN 60974-1:2005

English version

Arc welding equipment
Part 1: Welding power sources
(IEC 60974-1:2012)

Matériel de soudage à l'arc
Partie 1: Sources de courant de soudage
(CEI 60974-1:2012)

Lichtbogenschweißeinrichtungen -
Teil 1: Schweißstromquellen
(IEC 60974-1:2012)

This European Standard was approved by CENELEC on 2012-07-17. CENELEC members are bound to comply with the CEN/CENELEC Internal Regulations which stipulate the conditions for giving this European Standard the status of a national standard without any alteration.

Up-to-date lists and bibliographical references concerning such national standards may be obtained on application to the CEN-CENELEC Management Centre or to any CENELEC member.

This European Standard exists in three official versions (English, French, German). A version in any other language made by translation under the responsibility of a CENELEC member into its own language and notified to the CEN-CENELEC Management Centre has the same status as the official versions.

CENELEC members are the national electrotechnical committees of Austria, Belgium, Bulgaria, Croatia, Cyprus, the Czech Republic, Denmark, Estonia, Finland, Former Yugoslav Republic of Macedonia, France, Germany, Greece, Hungary, Iceland, Ireland, Italy, Latvia, Lithuania, Luxembourg, Malta, the Netherlands, Norway, Poland, Portugal, Romania, Slovakia, Slovenia, Spain, Sweden, Switzerland, Turkey and the United Kingdom.

CENELEC

European Committee for Electrotechnical Standardization
Comité Européen de Normalisation Electrotechnique
Europäisches Komitee für Elektrotechnische Normung

Management Centre: Avenue Marnix 17, B - 1000 Brussels

Foreword

The text of document 26/472/FDIS, future edition 4 of IEC 60974-1, prepared by IEC/TC 26, "Electric welding" was submitted to the IEC-CENELEC parallel vote and approved by CENELEC as EN 60974-1:2012.

The following dates are fixed:

- latest date by which the document has to be implemented at national level by publication of an identical national standard or by endorsement (dop) 2013-04-17
- latest date by which the national standards conflicting with the document have to be withdrawn (dvw) 2015-07-17

This document supersedes EN 60974-1:2005.

EN 60974-1:2012 includes the following significant technical changes with respect to EN 60974-1:2005:

- the heating test shall be carried out at ambient temperature of 40 °C (see 5.1);
- new Figure 1 summarizes example of insulation requirements;
- creepage distances for pollution degree 4 are no longer valid (see Table 2);
- insulation requirements for Class II equipment are defined (see Table 3);
- dielectric test voltage interpolation restriction lower limit is changed to 220 V and interpolation for control and welding circuit is clarified (see Table 4);
- water test is clarified by suppression of visual inspection (see 6.2.1);
- isolation requirements of the supply circuit and the welding circuit are moved in protection against electric shock in normal service (see 6.2.4);
- touch current in normal service and in single fault condition requirements are changed (see 6.2.5, 6.2.6 and 6.3.6);
- maximum temperature for insulation systems are reviewed in accordance with current edition of EN 60085 (see Table 6);
- limits of temperature rise for external surfaces are updated depending of unintentional contact period as defined in EN ISO 13732-1 (see Table 7);
- loading test is completed by a dielectric test (see 7.4);
- conformity test for tolerance to supply voltage fluctuation is clarified (see 10.1);
- marking of terminals is limited to external protective conductor and three-phase equipment terminals (see 10.4);
- usage of hazard reducing device is clarified (see 11.1);
- requirements for control circuits are changed (see Clause 12);
- impact test is clarified (see 14.2.2);
- environmental parameters are completed (see Annex M).

In this standard, the following print types are used:

– *conformity statements: in italic type.*

Attention is drawn to the possibility that some of the elements of this document may be the subject of patent rights. CENELEC [and/or CEN] shall not be held responsible for identifying any or all such patent rights.

This standard covers the Principle Elements of the Safety Objectives for Electrical Equipment Designed for Use within Certain Voltage Limits (LVD - 2006/95/EC)

Endorsement notice

The text of the International Standard IEC 60974-1:2012 was approved by CENELEC as a European Standard without any modification.

In the official version, for Bibliography, the following notes have to be added for the standards indicated:

IEC 60038:2009	NOTE Harmonized as EN 60038:2011 (modified).
IEC 60085	NOTE Harmonized as EN 60085.
IEC 60204-1	NOTE Harmonized as EN 60204-1.
IEC 60309-1	NOTE Harmonized as EN 60309-1.
IEC 60950-1	NOTE Harmonized as EN 60950-1.
IEC 60974-6	NOTE Harmonized as EN 60974-6.
IEC 60974-10	NOTE Harmonized as EN 60974-10.
IEC 60974-12	NOTE Harmonized as EN 60974-12.
IEC 61558-1	NOTE Harmonized as EN 61558-1.
IEC 62079	NOTE Harmonized as EN 62079.
ISO 13732-1	NOTE Harmonized as EN ISO 13732-1

Annex ZA
(normative)

**Normative references to international publications
with their corresponding European publications**

The following documents, in whole or in part, are normatively referenced in this document and are indispensable for its application. For dated references, only the edition cited applies. For undated references, the latest edition of the referenced document (including any amendments) applies.

NOTE When an international publication has been modified by common modifications, indicated by (mod), the relevant EN/HD applies.

<u>Publication</u>	<u>Year</u>	<u>Title</u>	<u>EN/HD</u>	<u>Year</u>
IEC 60050-151	2001	International Electrotechnical Vocabulary (IEV) - Part 151: Electrical and magnetic devices	-	-
IEC 60050-851	2008	International Electrotechnical Vocabulary - Part 851: Electric welding	-	-
IEC 60245-6	-	Rubber insulated cables - Rated voltages up to and including 450/750 V - Part 6: Arc welding electrode cables	-	-
IEC 60417	Data-base	Graphical symbols for use on equipment	-	-
IEC 60445	-	Basic and safety principles for man-machine interface, marking and identification - Identification of equipment terminals, conductor terminations and conductors	EN 60445	-
IEC 60529	-	Degrees of protection provided by enclosures - (IP Code)	-	-
IEC 60664-1	2007	Insulation coordination for equipment within low-voltage systems - Part 1: Principles, requirements and tests	EN 60664-1	2007
IEC 60664-3	-	Insulation coordination for equipment within low-voltage systems - Part 3: Use of coating, potting or moulding for protection against pollution	EN 60664-3	-
IEC 60695-11-10	-	Fire hazard testing - Part 11-10: Test flames - 50 W horizontal and vertical flame test methods	EN 60695-11-10	-
IEC 60974-7	-	Arc welding equipment - Part 7: Torches	EN 60974-7	-
IEC 61140	-	Protection against electric shock - Common aspects for installation and equipment	EN 61140	-
IEC 61558-2-4	-	Safety of transformers, reactors, power supply units and similar products for supply voltages up to 1 100 V - Part 2-4: Particular requirements and tests for isolating transformers and power supply units incorporating isolating transformers	EN 61558-2-4	-

<u>Publication</u>	<u>Year</u>	<u>Title</u>	<u>EN/HD</u>	<u>Year</u>
IEC 61558-2-6	-	Safety of transformers, reactors, power supply units and similar products for supply voltages up to 1 100 V - Part 2-6: Particular requirements and tests for safety isolating transformers and power supply units incorporating safety isolating transformers	EN 61558-2-6	-

<http://www.china-gauges.com/>

CONTENTS

1	Scope.....	9
2	Normative references.....	9
3	Terms and definitions	10
4	Environmental conditions	18
5	Tests	19
5.1	Test conditions	19
5.2	Measuring instruments.....	19
5.3	Conformity of components	19
5.4	Type tests	20
5.5	Routine tests	20
6	Protection against electric shock.....	21
6.1	Insulation.....	21
6.1.1	General	21
6.1.2	Clearances	22
6.1.3	Creepage distances	23
6.1.4	Insulation resistance	25
6.1.5	Dielectric strength.....	25
6.2	Protection against electric shock in normal service (direct contact).....	26
6.2.1	Protection provided by the enclosure.....	26
6.2.2	Capacitors	27
6.2.3	Automatic discharge of supply circuit capacitors.....	27
6.2.4	Isolation of the welding circuit	28
6.2.5	Welding circuit touch current.....	28
6.2.6	Touch current in normal condition	29
6.3	Protection against electric shock in case of a fault condition (indirect contact)	29
6.3.1	Protective provisions.....	29
6.3.2	Isolation between windings of the supply circuit and the welding circuit.....	29
6.3.3	Internal conductors and connections	29
6.3.4	Additional requirements for plasma cutting systems	30
6.3.5	Movable coils and cores.....	30
6.3.6	Touch current in fault condition	31
7	Thermal requirements.....	31
7.1	Heating test	31
7.1.1	Test conditions	31
7.1.2	Tolerances of the test parameters	32
7.1.3	Duration of test	32
7.2	Temperature measurement.....	32
7.2.1	Measurement conditions	32
7.2.2	Surface temperature sensor.....	32
7.2.3	Resistance.....	33
7.2.4	Embedded temperature sensor	33
7.2.5	Determination of the ambient air temperature	33
7.2.6	Recording of temperatures.....	33
7.3	Limits of temperature rise	34

7.3.1	Windings, commutators and slip-rings	34
7.3.2	External surfaces	34
7.3.3	Other components	35
7.4	Loading test	36
7.5	Commutators and slip-rings	36
8	Thermal protection	36
8.1	General requirements	36
8.2	Construction	36
8.3	Location	36
8.4	Operating capacity	36
8.5	Operation	37
8.6	Resetting	37
8.7	Indication	37
9	Abnormal operation	37
9.1	General requirements	37
9.2	Stalled fan test	38
9.3	Short circuit test	38
9.4	Overload test	38
10	Connection to the supply network	39
10.1	Supply voltage	39
10.2	Multi-supply voltage	39
10.3	Means of connection to the supply circuit	39
10.4	Marking of terminals	40
10.5	Protective circuit	40
10.5.1	Continuity requirement	40
10.5.2	Type test	41
10.5.3	Routine test	41
10.6	Cable anchorage	42
10.7	Inlet openings	43
10.8	Supply circuit on/off switching device	43
10.9	Supply cables	44
10.10	Supply coupling device (attachment plug)	44
11	Output	45
11.1	Rated no-load voltage	45
11.1.1	Rated no-load voltage for use in environments with increased risk of electric shock	45
11.1.2	Rated no-load voltage for use in environments without increased risk of electric shock	45
11.1.3	Rated no-load voltage for the use with mechanically held torches with increased protection for the operator	45
11.1.4	Rated no-load voltage for special processes for example plasma cutting	45
11.1.5	Additional requirements	46
11.1.6	Measuring circuits	47
11.2	Type test values of the conventional load voltage	48
11.2.1	Manual metal arc welding with covered electrodes	48
11.2.2	Tungsten inert gas	48
11.2.3	Metal inert/active gas and flux cored arc welding	48
11.2.4	Submerged arc welding	48

<http://www.china-gauges.com/>

11.2.5	Plasma cutting	48
11.2.6	Plasma welding	48
11.2.7	Plasma gouging	48
11.2.8	Additional requirements	48
11.3	Mechanical switching devices used to adjust output	48
11.4	Welding circuit connections	49
11.4.1	Protection against unintentional contact	49
11.4.2	Location of coupling devices	49
11.4.3	Outlet openings	49
11.4.4	Three-phase multi-operator welding transformer	49
11.4.5	Marking	49
11.4.6	Connections for plasma cutting torches	50
11.5	Power supply to external devices connected to the welding circuit	50
11.6	Auxiliary power supply	50
11.7	Welding cables	51
12	Control circuits	51
12.1	General requirement	51
12.2	Isolation of control circuits	51
12.3	Working voltages of remote control circuits	51
13	Hazard reducing device	51
13.1	General requirements	51
13.2	Types of hazard reducing devices	52
13.2.1	Voltage reducing device	52
13.2.2	Switching device for a.c. to d.c.	52
13.3	Requirements for hazard reducing devices	52
13.3.1	Disabling the hazard reducing device	52
13.3.2	Interference with operation of a hazard reducing device	52
13.3.3	Indication of satisfactory operation	53
13.3.4	Fail to a safe condition	53
14	Mechanical provisions	53
14.1	General requirements	53
14.2	Enclosure	53
14.2.1	Enclosure materials	53
14.2.2	Enclosure strength	53
14.3	Handling means	54
14.3.1	Mechanised handling	54
14.3.2	Manual handling	54
14.4	Drop withstand	55
14.5	Tilting stability	55
15	Rating plate	55
15.1	General requirements	55
15.2	Description	55
15.3	Contents	56
15.4	Tolerances	59
15.5	Direction of rotation	60
16	Adjustment of the output	60
16.1	Type of adjustment	60
16.2	Marking of the adjusting device	60

16.3	Indication of current or voltage control	60
17	Instructions and markings	61
17.1	Instructions	61
17.2	Markings	62
Annex A (informative)	Nominal voltages of supply networks	63
Annex B (informative)	Example of a combined dielectric test	64
Annex C (normative)	Unbalanced load in case of a.c. tungsten inert-gas welding power sources	65
Annex D (informative)	Extrapolation of temperature to time of shutdown	67
Annex E (normative)	Construction of supply circuit terminals	68
Annex F (informative)	Cross-reference to non-SI units	70
Annex G (informative)	Suitability of supply network for the measurement of the true r.m.s. value of the supply current	71
Annex H (informative)	Plotting of static characteristics	72
Annex I (normative)	Test methods for a 10 Nm impact	73
Annex J (normative)	Thickness of sheet metal for enclosures	74
Annex K (informative)	Examples of rating plates	76
Annex L (informative)	Graphical symbols for arc welding equipment	81
Annex M (informative)	Efficiency	104
Annex N (normative)	Touch current measurement in fault condition	105
Bibliography	109
Figure 1	– Example of insulation configuration for Class I equipment	21
Figure 2	– Measurement of welding circuit touch current	28
Figure 3	– Measurement of r.m.s. values	47
Figure 4	– Measurement of peak values	47
Figure 5	– Principle of the rating plate	56
Figure B.1	– Combined high-voltage transformers	64
Figure C.1	– Voltage and current during a.c. tungsten inert-gas welding	65
Figure C.2	– Unbalanced voltage during a.c. tungsten inert-gas welding	66
Figure C.3	– AC welding power source with unbalanced load	66
Figure I.1	– Test set-up	73
Figure K.1	– Single-phase transformer	76
Figure K.2	– Three-phase rotating frequency converter	77
Figure K.3	– Subdivided rating plate: single-/three-phase transformer rectifier	78
Figure K.4	– Engine-generator-rectifier	79
Figure K.5	– Single-/three-phase inverter type	80
Figure L.1	– Input voltage power switch	101
Figure L.2	– Arc force control potentiometer	101
Figure L.3	– Remote receptacle and selector switches	102
Figure L.4	– Terminals with inductance selector for MIG/MAG welding	102
Figure L.5	– Process switch (MMA, TIG, MIG)	102
Figure L.6	– Selector switch on AC/DC equipment	102
Figure L.7	– Panel indicator lights (overheat, fault, arc striking, output voltage)	103

Figure L.8 – Setting pulsing parameters using digital display.....	103
Figure N.1 – Measuring network for weighted touch current	105
Figure N.2 – Diagram for touch current measurement on fault condition at operating temperature for single-phase connection of appliances other than those of class II	107
Figure N.3 – Diagram for touch current measurement on fault condition for three-phase four-wire system connection of appliances other than those of class II	108
Table 1 – Minimum clearances for overvoltage category III	22
Table 2 – Minimum creepage distances	24
Table 3 – Insulation resistance	25
Table 4 – Dielectric test voltages	25
Table 5 – Minimum distance through insulation.....	29
Table 6 – Temperature limits for windings, commutators and slip-rings	34
Table 7 – Temperature limits for external surfaces	35
Table 8 – Cross-section of the output short-circuit conductor	38
Table 9 – Current and time requirements for protective circuits	41
Table 10 – Minimum cross-sectional area of the external protective copper conductor	41
Table 11 – Verification of continuity of the protective circuit	42
Table 12 – Pull.....	43
Table 13 – Summary of allowable rated no-load voltages	46
Table 14 – Hazard reducing device requirements.....	52
Table E.1 – Range of conductor dimensions to be accepted by the supply circuit terminals.....	68
Table F.1 – Cross-reference for mm ² to American wire gauge (AWG)	70
Table I.1 – Angle of rotation θ to obtain 10 Nm impact	73
Table I.2 – Mass of the free fall weight and height of the free fall	73
Table J.1 – Minimum thickness of sheet metal for steel enclosures.....	74
Table J.2 – Minimum thickness of sheet metal for enclosures of aluminium, brass or copper	75
Table L.1 – Letters used as symbols	82

ARC WELDING EQUIPMENT –

Part 1: Welding power sources

1 Scope

This part of IEC 60974 is applicable to power sources for arc welding and allied processes designed for industrial and professional use, and supplied by a voltage not exceeding 1 000 V, or driven by mechanical means.

This part of IEC 60974 specifies safety and performance requirements of welding power sources and plasma cutting systems.

This part of IEC 60974 is not applicable to welding power sources for manual metal arc welding with limited duty operation which are designed mainly for use by laymen and designed in accordance with IEC 60974-6.

This part of IEC 60974 is not applicable to testing of power sources during periodic maintenance or after repair.

NOTE 1 Typical allied processes are electric arc cutting and arc spraying.

NOTE 2 AC systems having a nominal voltage between 100 V and 1 000 V are given in Table 1 of IEC 60038:2009.

NOTE 3 This part of IEC 60974 does not include electromagnetic compatibility (EMC) requirements.

2 Normative references

The following documents, in whole or in part, are normatively referenced in this document and are indispensable for its application. For dated references, only the edition cited applies. For undated references, the latest edition of the referenced document (including any amendments) applies.

IEC 60050-151:2001, *International Electrotechnical Vocabulary (IEV) – Part 151: Electrical and magnetic devices*

IEC 60050-851:2008, *International Electrotechnical Vocabulary (IEV) – Part 851: Electric welding*

IEC 60245-6, *Rubber insulated cables – Rated voltages up to and including 450/750 V – Part 6: Arc welding electrode cables*

IEC 60417-DB:20111, *Graphical symbols for use on equipment*

IEC 60445, *Basic and safety principles for man-machine interface, marking and identification – Identification of equipment terminals, conductor terminations and conductors*

IEC 60529, *Degrees of protection provided by enclosures (IP Code)*

¹ “DB” refers to the IEC on-line database.

IEC 60664-1:2007, *Insulation coordination for equipment within low-voltage systems – Part 1: Principles, requirements and tests*

IEC 60664-3, *Insulation coordination for equipment within low-voltage systems – Part 3: Use of coating, potting or moulding for protection against pollution*

IEC 60695-11-10, *Fire hazard testing – Part 11-10: Test flames – 50 W horizontal and vertical flame test methods*

IEC 60974-7, *Arc welding equipment – Part 7: Torches*

IEC 61140, *Protection against electric shock – Common aspects for installation and equipment*

IEC 61558-2-4, *Safety of transformers, reactors, power supply units and similar products for supply voltages up to 1 100 V – Part 2-4: Particular requirements and tests for isolating transformers and power supply units incorporating isolating transformers*

IEC 61558-2-6, *Safety of transformers, reactors, power supply units and similar products for supply voltages up to 1 100 V – Part 2-6: Particular requirements and tests for safety isolating transformers and power supply units incorporating safety isolating transformers*

3 Terms and definitions

For the purposes of this document, the terms and definitions given in IEC 60050-151, IEC 60050-851 and IEC 60664-1, as well as the following, apply.

3.1

arc welding power source

equipment for supplying current and voltage and having the required characteristics suitable for arc welding and allied processes

Note 1 to entry An arc welding power source can also supply services to other equipment and auxiliaries for example auxiliary power, cooling liquid, consumable arc welding electrode and gas to shield the arc and the welding area.

Note 2 to entry In the following text, the term "welding power source" is used.

3.2

industrial and professional use

use intended only for experts or instructed persons

3.3

expert

competent person

skilled person

a person who can judge the work assigned and recognize possible hazards on the basis of professional training, knowledge, experience and knowledge of the relevant equipment

Note 1 to entry Several years of practice in the relevant technical field can be taken into consideration in assessment of professional training.

3.4

instructed person

person informed about the tasks assigned and about the possible hazards involved in neglectful behaviour

Note 1 to entry If necessary, the person has undergone some training.

3.5

type test

test of one or more devices made to a given design to check if these devices comply with the requirements of the standard concerned

3.6

routine test

test made on each individual device during or after manufacture to check if it complies with the requirements of the standard concerned or the criteria specified

3.7

visual inspection

inspection by eye to verify that there are no apparent discrepancies with respect to provisions of the standard concerned

3.8

drooping characteristic

external static characteristic of a welding power source which, in its normal welding range, is such that the negative slope is greater than or equal to 7 V/100 A

3.9

flat characteristic

external static characteristic of a welding power source which, in its normal welding range, is such that, as the current increases, the voltage either decreases by less than 7 V/100 A or increases by less than 10 V/100 A

3.10

static characteristic

relationship between the voltage and the current at the output terminals of a welding power source when connected to a conventional load

3.11

welding circuit

conductive material through which the welding current is intended to flow

Note 1 to entry In arc welding, the arc is a part of the welding circuit.

Note 1 to entry In certain arc welding processes, the welding arc can be established between two electrodes. In such a case, the workpiece is not necessarily a part of the welding circuit.

3.12

control circuit

internal or external circuit for the operational control of the equipment or for protection of the power circuits, or both

EXAMPLE 1 Control circuits intended for interface between the welding power source and external equipment designed by the manufacturer.

EXAMPLE 2 Control circuits intended for interface between the welding power source and other types of ancillary equipment.

3.13

welding current

current delivered by a welding power source during welding

3.14

load voltage

voltage between the output terminals when the welding power source is delivering welding current

3.15

no-load voltage

voltage, exclusive of any arc striking or arc stabilizing voltage, between the accessible output terminals of a welding power source when the welding circuit is open but energized

3.16

conventional value

standardized value that is used as a measure of a parameter for the purposes of comparison, calibration, testing etc.

NOTE Conventional values do not necessarily apply during the actual welding process.

3.17

conventional welding condition

condition of the welding power source in the energized and thermally stabilized state defined by a conventional welding current, given by the corresponding conventional load voltage through a conventional load at rated supply voltage and frequency or speed of rotation

3.18

conventional load

practically non-inductive constant resistive load having a power factor not less than 0,99

3.19

conventional welding current

I_2

current delivered by a welding power source to a conventional load at the corresponding conventional load voltage

Note 1 to entry The values of I_2 are given as r.m.s. values for a.c. and arithmetic mean values for d.c.

3.20

conventional load voltage

U_2

load voltage of a welding power source having a specified linear relationship to the conventional welding current

Note 1 to entry The values for U_2 are given as r.m.s. values for a.c. and arithmetic mean values for d.c.

Note 1 to entry The specified linear relationship varies in accordance with the process (see 11.2).

3.21

rated value

assigned value, generally by the manufacturer, for a specified operating condition of a component, device or equipment

3.22

rating plate

name plate

plate, permanently affixed on an electric device, which indelibly states the rating and other information as required by the relevant standard

[SOURCE: IEC 60050-151:2001, 151-16-12]

3.23

rated output

rated values of the output of the equipment

3.24
rated maximum welding current

I_{2max}

maximum value of the conventional welding current that can be obtained at the conventional welding condition from a welding power source at its maximum setting

3.25
rated minimum welding current

I_{2min}

minimum value of the conventional welding current that can be obtained at the conventional welding condition from a welding power source at its minimum setting

3.26
rated no-load voltage

U_0

no-load voltage at rated supply voltage and frequency or rated no-load speed of rotation

Note 1 to entry If a welding power source is fitted with a hazard reducing device, this is the voltage measured before the hazard reducing device has performed its function.

3.27
rated reduced no-load voltage

U_r

no-load voltage of a welding power source, fitted with a voltage reducing device immediately after the device acts to effect a reduction in the voltage

3.28
rated switched no-load voltage

U_s

d.c. no-load voltage of a welding power source, fitted with an a.c. to d.c. switching device

3.29
rated supply voltage

U_1

r.m.s. value of supply voltage for which the equipment is designed

3.30
rated supply current

I_1

r.m.s. value of supply current to the welding power source at a rated conventional welding condition

3.31
rated no-load supply current

I_0

r.m.s. value of supply current to the welding power source at rated no-load voltage

3.32
rated maximum supply current

I_{1max}

maximum value of the rated supply current

<http://www.china-gauges.com/>

3.33
maximum effective supply current

$I_{1\text{eff}}$

maximum value of the effective supply current, calculated from the rated supply current (I_1), the corresponding duty cycle (X) and the supply current at no-load (I_0) by the formula:

$$I_{1\text{eff}} = \sqrt{I_1^2 \times X + I_0^2 \times (1-X)}$$

3.34
rated load speed

n

speed of rotation of an engine-driven welding power source when operating at rated maximum welding current

3.35
rated no-load speed

n_0

speed of rotation of an engine-driven welding power source when the external welding circuit is open

Note 1 to entry If an engine is fitted with a device to reduce the speed when not welding, n_0 will be measured before the speed reduction device has operated.

3.36
rated idle speed

n_i

reduced no-load speed of an engine-driven welding power source

3.37
duty cycle

X

SUPERSEDED: duty factor

ratio, for a given time interval, of the uninterrupted on-load duration to the total time

Note 1 to entry This ratio, lying between 0 and 1, is expressed as a percentage.

Note 2 to entry For the purposes of this document, the time period of one complete cycle is 10 min. For example, in the case of a 60 % duty cycle, a continuous 6 min load period is followed by a no-load period of 4 min.

3.38
clearance

shortest distance in air between two conductive parts

[SOURCE: IEC 60664-1:2007, 3.2]

3.39
creepage distance

shortest distance along the surface of a solid insulating material between two conductive parts

[SOURCE: IEC 60664-1:2007, 3.3]

3.40
pollution degree

numeral characterizing the expected pollution of the micro-environment

[SOURCE: IEC 60664-1:2007, 3.13]

Note 1 to entry For the purpose of evaluating creepage distances and clearances, the following four pollution degrees in the micro-environment are established in 4.6.2 of IEC 60664-1:2007.

- a) **Pollution degree 1:** No pollution or only dry, non-conductive pollution occurs. The pollution has no influence.
- b) **Pollution degree 2:** Only non-conductive pollution occurs except that occasionally a temporary conductivity caused by condensation is to be expected.
- c) **Pollution degree 3:** Conductive pollution occurs, or dry, non-conductive pollution occurs which becomes conductive due to condensation which is to be expected.
- d) **Pollution degree 4:** The pollution generates persistent conductivity caused by conductive dust or by rain or snow.

3.41 micro-environment

immediate environment of the insulation which particularly influences the dimensioning of the creepage distances

[SOURCE: IEC 60664-1:2007, 3.12.2]

3.42 material group

materials separated into four groups by their comparative tracking index (CTI) values in accordance with IEC 60664-1

Note 1 to entry The following four groups are defined in IEC 60664-1:

Material group I $600 \leq \text{CTI}$

Material group II $400 \leq \text{CTI} < 600$

Material group IIIa $175 \leq \text{CTI} < 400$

Material group IIIb $100 \leq \text{CTI} < 175$

3.43 temperature rise

difference between the temperature of a part of the equipment and that of the ambient air

3.44 thermal equilibrium

state reached when the observed temperature rise of any part of the equipment does not exceed 2 K/h

3.45 thermal protection

system intended to ensure the protection of a part, and hence the whole, of the equipment against excessive temperatures resulting from certain conditions of thermal overload

Note 1 to entry It is capable of being reset (either manually or automatically) when the temperature falls to the reset value.

3.46 environment with increased risk of electric shock

environment where the probability of electric shock by arc welding is increased in relation to normal arc welding conditions

Note 1 to entry Such environments are found, for example:

- a) in locations in which freedom of movement is restricted, so that the operator is forced to perform the welding in a cramped (for example kneeling, sitting, lying) position with physical contact with conductive parts;
- b) in locations which are fully or partially limited by conductive elements, and in which there is a high probability of unavoidable or accidental contact by the operator;

c) in wet or damp or hot locations where humidity or perspiration considerably reduces the skin resistance of the human body and the insulating properties of accessories.

3.47

hazard reducing device

device designed to reduce the hazard of electric shock that may originate from the no-load voltage

3.48

class I equipment

equipment with basic insulation as provision for basic protection and protective bonding as provision for fault protection

3.49

class II equipment

equipment with basic insulation as provision for basic protection, and supplementary insulation as provision for fault protection, or in which basic and fault protection are provided by reinforced insulation

3.50

basic insulation

insulation of hazardous-live-parts which provides basic protection

[SOURCE: IEC 60050-826 :2004, 826-12-14]

3.51

supplementary insulation

independent insulation applied in addition to basic insulation for fault protection

[SOURCE: IEC 60050-826:2004, 826-12-15]

3.52

double insulation

insulation comprising both basic insulation and supplementary insulation

[SOURCE: IEC 60050-826:2004, 826-12-16]

3.53

reinforced insulation

insulation of hazardous-live-parts which provides a degree of protection against electric shock equivalent to double insulation

Note 1 to entry Reinforced insulation may comprise several layers which cannot be tested singly as basic insulation or supplementary insulation.

[SOURCE: IEC 60050-826:2004, 826-12-17]

3.54

plasma cutting system

combination of power source, torch, and associated safety devices for plasma cutting/gouging

3.55

plasma cutting power source

equipment for supplying current and voltage and having the required characteristics suitable for plasma cutting/gouging and which may supply gas and cooling liquid

Note 1 to entry A plasma cutting power source can also supply services to other equipment and auxiliaries, for example auxiliary power, cooling liquid and gas.

3.56 **safety extra low voltage** **SELV**

voltage which does not exceed 50 V a.c. or 120 V ripple free d.c. between conductors, or between any conductor and earth, in a circuit which is isolated from the supply mains by such means as a safety isolating transformer

Note 1 to entry Maximum voltage lower than 50 V a.c. or 120 V ripple free d.c. is specified in particular requirements, especially when direct contact with live parts is allowed.

Note 2 to entry The voltage limit is not exceeded at any load between full load and no-load when the source is a safety isolating transformer.

Note 3 to entry "Ripple-free" is conventionally an r.m.s. ripple voltage not more than 10 % of the d.c. component; the maximum peak value does not exceed 140 V for a nominal 120 V ripple-free d.c. system and 70 V for a nominal 60 V ripple-free d.c. system.

[SOURCE: IEC 60050-851:2008, 851-15-08, modified]

3.57 **supply circuit** **input circuit**

conductive material in the equipment through which the supply current is intended to flow

3.58 **working voltage**

highest r.m.s. value of the a.c. or d.c. voltage across any particular insulation which can occur when the equipment is supplied at rated voltage

Note 1 to entry Transients are disregarded.

Note 2 to entry Both open circuit conditions and normal operating conditions are taken into account.

3.59 **touch current**

electric current passing through a human body or through an animal body when it touches one or more accessible parts of an installation or of equipment

[SOURCE: IEC 60050-195:1998, 195-05-21]

Note 1 to entry Touch current is measured by using a measuring network that simulates the impedance of the human body.

3.60 **remote control**

device or circuit external to the equipment used for monitoring or operational control

3.61 **single-fault condition**

condition in which one means for protection against hazard is defective

Note 1 to entry If a single-fault condition results unavoidably in another single-fault condition, the two failures are considered as one single-fault condition.

[SOURCE: IEC 60050-851:2008, 851-11-20]

3.62 **fixed installation**

particular combination of several types of apparatus and, where applicable, other devices, which are assembled, installed and intended to be used permanently at a predefined location

3.63

protective circuit

circuit intended to be bonded to protective earth to protect against electric shock

3.64

class of insulation

a standard classification applied to an insulating material for use in electrical apparatus and machines and specifying the nature of the material and a recommended limiting temperature

[SOURCE: IEC 60050-811:1991, 811-13-33]

3.65

functional insulation

insulation between conductive parts, necessary for the proper functioning of the equipment

[SOURCE: IEC 60050-195:1998, 195-02-41]

3.66

idle state

operating state in which the power is switched on and the welding circuit is not energized

Note 1 to entry For some types of equipment there is no idle state, but a welding state preceding arc striking.

Note 2 to entry For a power source in a mechanised system, the configuration to achieve idle state is defined by the manufacturer.

3.67

standby mode

non operating state in which the supply circuit on/off switching device is off

Note 1 to entry By design, most power sources for manual welding do not have any energy consumption in standby mode.

Note 2 to entry For a power source in a mechanised system, the configuration to achieve standby mode is defined by the manufacturer.

4 Environmental conditions

Welding power sources shall be capable of delivering rated outputs at rated duty cycles when the following environmental conditions prevail:

- a) range of ambient air temperature:
during operation: -10 °C to $+40\text{ °C}$;
- b) relative humidity of the air:
up to 50 % at 40 °C ;
up to 90 % at 20 °C ;
- c) ambient air, free from abnormal amounts of dust, acids, corrosive gases or substances, etc. other than those generated by the welding process;
- d) altitude above sea level up to 1 000 m;
- e) base of the welding power source inclined up to 10° .

Welding power sources shall withstand storage and transport at an ambient air temperature of -20 °C to $+55\text{ °C}$ without any damage to function and performance.

NOTE Different environmental conditions can be agreed upon between the manufacturer and the purchaser and the resulting welding power source is marked accordingly (see 15.1). Examples of these conditions are: high humidity, unusually corrosive fumes, steam, excessive oil vapour, abnormal vibration or shock, excessive dust, severe weather conditions, unusual coastal or shipboard conditions, vermin infestation and atmospheres conducive to the growth of mould.

5 Tests

5.1 Test conditions

Tests shall be carried out on new, dry and completely assembled welding power sources.

The heating test defined in 7.1 and the thermal protection test defined in 7.2 shall be carried out at ambient temperature of 40 °C, see tolerances in 7.1.2 e), with the exception of engine-driven power sources and fixed installation equipment, which shall be tested in accordance with the manufacturer's specification.

Other tests shall be carried out at any ambient air temperature given in 4 a).

Liquid-cooled welding power sources shall be tested with liquid conditions as specified by the manufacturer.

Unless otherwise specified, the equipment shall be supplied by a rated supply voltage with a tolerance of ± 5 %.

5.2 Measuring instruments

The accuracy of measuring instruments shall be:

- a) electrical measuring instruments: class 1 (± 1 % of full-scale reading), except for the measurement of insulation resistance and dielectric strength where the accuracy of the instruments is not specified, but shall be taken into account for the measurement;
- b) thermometer: ± 2 K;
- c) tachometer: ± 1 % of full-scale reading.

5.3 Conformity of components

Components which due to failure can create a hazard, shall comply with the requirements of this document or with the requirements of the relevant IEC standards.

NOTE 1 An IEC component standard is considered relevant only if the component in question falls within its scope.

Evaluation and testing of components for correct application in the equipment shall be carried out in one of the following ways:

- a) Where a component has been certified by a recognized testing authority for compliance with a relevant IEC component standard, that component shall be checked for correct application and use in accordance with its rating. The component shall be tested in accordance with this part of IEC 60974 with the exception of those tests which are part of the relevant IEC component standard.
- b) Where a component has been certified by a recognized testing authority for compliance with a relevant IEC component standard, but is not being used in accordance with its specified ratings, that component shall be tested in accordance with this part of IEC 60974.
- c) Where a component has not been certified by a recognized testing authority for compliance with a relevant IEC component standard, that component shall be checked for correct application in the equipment by testing the component in accordance with this part of IEC 60974 or in accordance with the applicable tests of the relevant IEC component standard.

NOTE 2 The applicable test for compliance with a component standard is typically carried out separately. The number of test samples is typically the same as that required in the component standard.

- d) Where a component has not been certified by a recognized testing authority for compliance with a relevant IEC component standard because no such standard exists, that component shall be tested in accordance with this part of IEC 60974.
- e) Where a component has been certified by a recognized testing authority for compliance to a non-IEC standard, that component shall be considered acceptable for use on the equipment provided that the applicable safety requirements of the non-IEC standard are at least as high as those of a relevant IEC standard. The component shall be tested in accordance with this part of IEC 60974 with the exception of those tests which are part of the non-IEC component standard.

5.4 Type tests

Unless otherwise specified, the tests in this document are type tests.

The welding power source shall be tested with any ancillary equipment fitted that could affect the test results.

All type tests shall be carried out on the same welding power source except where it is specified that a test may be carried out on another welding power source.

As a condition of conformity, the type tests given below shall be carried out in the following sequence with no drying time between f), g) and h):

- a) general visual inspection, see 3.7;
- b) insulation resistance, see 6.1.4 (preliminary check);
- c) enclosure, see 14.2;
- d) handling means, see 14.3;
- e) drop withstand, see 14.4;
- f) protection provided by the enclosure, see 6.2.1;
- g) insulation resistance, see 6.1.4;
- h) dielectric strength, see 6.1.5;
- i) general visual inspection, see 3.7.

The other tests included in this document and not listed here shall be carried out, but may be completed in any convenient sequence.

5.5 Routine tests

All routine tests shall be carried out on each welding power source. The following sequence is recommended:

- a) visual inspection in accordance with manufacturer's specification;
- b) continuity of the protective circuit, see 10.5.1;
- c) dielectric strength, see 6.1.5;
- d) no-load voltage:
 - 1) rated no-load voltage, see 11.1; or
 - 2) if applicable, rated reduced no-load voltage, see 13.2; or
 - 3) if applicable, rated switched no-load voltage, see 13.3;
- e) test to ensure rated minimum and maximum output values in accordance with 15.4 b) and 15.4 c). The manufacturer may select conventional load, short circuit load or other test conditions.

NOTE In short circuit and other test conditions, the output values can differ from conventional load values.

6 Protection against electric shock

6.1 Insulation

6.1.1 General

The majority of welding power sources fall within the overvoltage category II in accordance with IEC 60664-1; mechanically powered welding power sources fall within overvoltage category II. All welding power sources shall be designed for use in environmental conditions of pollution degree 3 as a minimum.

Components or subassemblies with clearances or creepage distances corresponding to pollution degree 1 or 2 are permitted, if they are completely coated, potted or moulded in accordance with IEC 60664-3.

See Table 2 for printed wiring material creepage distances.

Class I equipment intended to be connected to an earthed three-phase three-wire system shall be designed with insulation based on line to line voltage values. Class I equipment designed with insulation based on line to neutral voltage values shall be provided with a caution that such equipment shall only be used on a supply network that is either a three-phase, four-wire system with an earthed neutral or a single-phase, three-wire, system with an earthed neutral.

The application of insulation in many configurations is illustrated in Figure 1, but other configurations and solutions are possible. If a particular configuration is not represented in Figure 1, the required insulation shall be determined by considering the effect of a single fault.

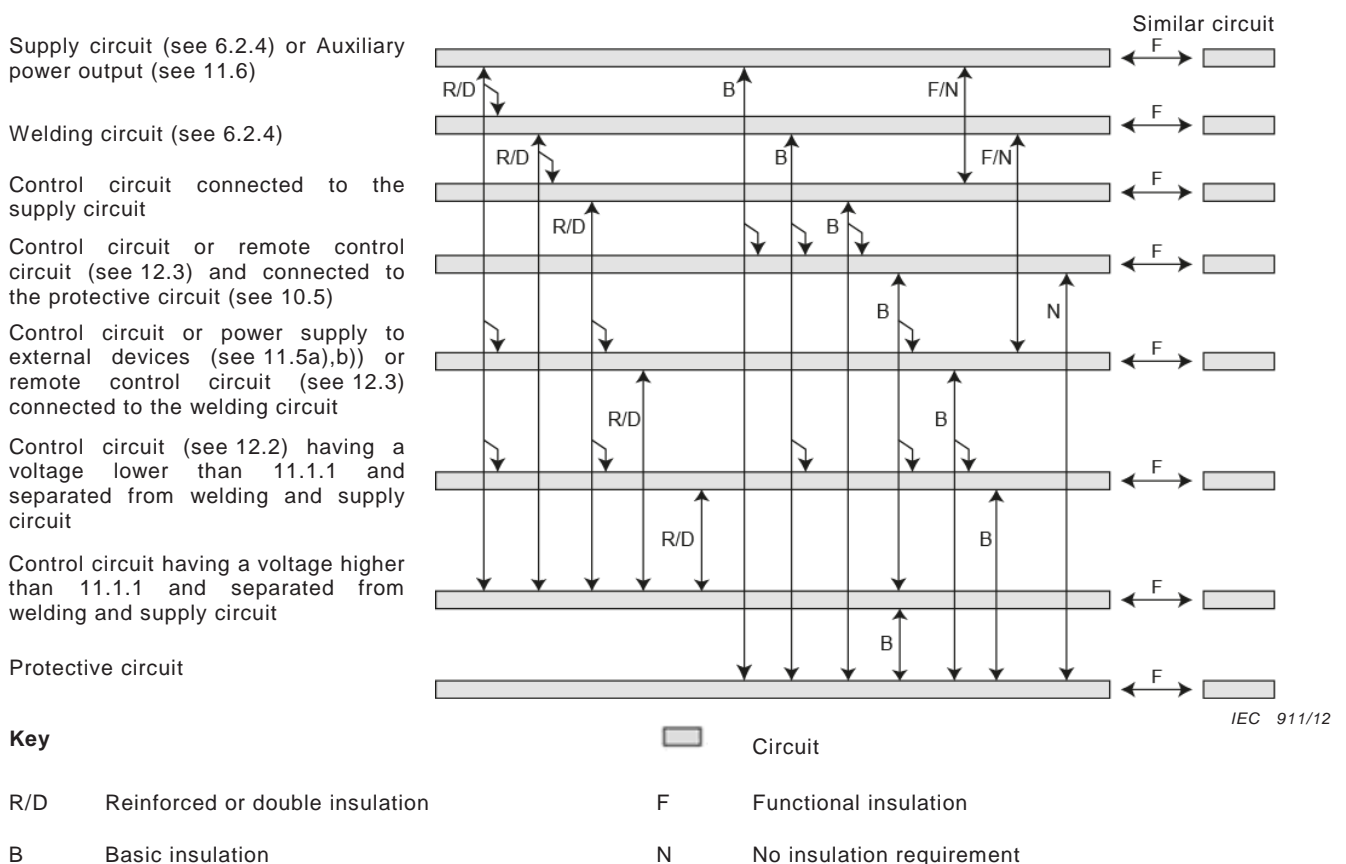

Figure 1 – Example of insulation configuration for Class I equipment

6.1.2 Clearances

For basic or supplementary insulation, and reinforced insulation, minimum clearances shall be in accordance with Table 1 for overvoltage category III. For other overvoltage categories, minimum clearances shall be in accordance with IEC 60664-1.

Table 1 – Minimum clearances for overvoltage category III

Voltage line to neutral derived from nominal voltages a.c. or d.c. up to and including ^a V r.m.s.	Basic or supplementary insulation					Reinforced insulation				
	Rated impulse Test voltage peak V	AC test voltage V r.m.s.	Pollution degree			Rated impulse test voltage peak V	AC test voltage V r.m.s.	Pollution degree		
			2	3	4			2	3	4
			Clearance mm					Clearance mm		
50	800	566	0,2	0,8	1,6	1 500	1 061	0,5	0,8	1,6
100	1 500	1 061	0,5		1,6	2 500	1 768	1,5		
150	2 500	1 768	1,5			4 000	2 828	3		
300	4 000	2 828	3			6 000	4 243	5,5		
600	6 000	4 243	5,5			8 000	5 657	8		
1 000	8 000	5 657	8			12 000	8 485	14		

NOTE 1 Values based on Tables F.1 and F.2 of IEC 60664-1:2007.

NOTE 2 For other pollution degrees and overvoltage categories, see IEC 60664-1.

NOTE 3 If an autotransformer is connected to the supply circuit and provided as a part of a welding power source, the supply voltage determines the clearances.

^a See Annex A.

For determining clearances as to accessible non-conductive surfaces, such surfaces shall be considered to be covered by metal foil wherever they can be touched by the standard test finger in accordance with IEC 60529.

Clearances shall not be interpolated.

For supply circuit terminals, see E.2.

Clearances between parts of the welding power source (for example electronic circuits or components) which are protected by an overvoltage limiting device (for example metal oxide varistor) may be rated in accordance with overvoltage category I (see IEC 60664-1).

The values of Table 1 shall also apply to the welding circuit within the welding power source and to control circuits when separated from the supply circuit, for example by a transformer.

If the control circuit is directly connected to the supply circuit, the values for the supply voltage shall apply.

Conformity shall be checked by measurement in accordance with 6.2 of IEC 60664-1:2007 or where this is not possible, by submitting the welding power source to an impulse test using the voltages given in Table 1.

For the impulse test, a minimum of three impulses of each polarity at the voltage given in Table 1 are applied with an interval of at least 1 s between impulses using a generator with an output waveform of 1,2/50 μs and an output impedance of less than 500 Ω.

Alternatively, either an a.c. test voltage as given in Table 1 may be applied for three cycles or a ripple free d.c. voltage, the value of which is equal to the impulse voltage, may be applied three times for 10 ms, for each polarity.

6.1.3 Creepage distances

Creepage distances for basic or supplementary insulation, shall be in accordance with Table 2.

Creepage distances for double insulation shall be the sum of the values for basic and supplementary insulation which form the double insulation.

Creepage distances for reinforced insulation shall be twice those determined for basic insulation.

For the purpose of dimensioning creepage distances to accessible non-conductive surfaces, such surfaces shall be considered to be covered by metal foil wherever they can be touched by the standard test finger in accordance with IEC 60529.

Creepage distances are given for the highest rated voltage of each line of Table 2. In the case of a lower rated voltage, interpolation is allowed.

For supply circuit terminals, see E.2.

The values of Table 2 shall also be applicable to the welding circuit within the welding power source and to control circuits when separated from the supply circuit by, for example, a transformer.

A creepage distance cannot be less than the associated clearance, so the shortest possible creepage distance is equal to the required clearance.

If the control circuit is connected directly to the supply circuit, the values for the supply voltage shall apply.

Conformity shall be checked by linear measurement in accordance with 6.2 of IEC 60664-1:2007.

Table 2 – Minimum creepage distances

Working voltage	Creepage distances in millimetres								
	Basic or supplementary insulation								
	Printed wiring material		Pollution degree						
	Pollution degree		1		2			3	
V r.m.s	1	2	1	Material group			Material group		
	a	b	a	I	II	III	II	III	
	mm	mm	mm	mm	mm	mm	mm	mm	
10	0,025	0,04	0,08	0,4	0,4	0,4	1	1	1
12,5	0,025	0,04	0,09	0,42	0,42	0,42	1,05	1,05	1,05
16	0,025	0,04	0,1	0,45	0,45	0,45	1,1	1,1	1,1
20	0,025	0,04	0,11	0,48	0,48	0,48	1,2	1,2	1,2
25	0,025	0,04	0,125	0,5	0,5	0,5	1,25	1,25	1,25
32	0,025	0,04	0,14	0,53	0,53	0,53	1,3	1,3	1,3
40	0,025	0,04	0,16	0,56	0,8	1,1	1,4	1,6	1,8
50	0,025	0,04	0,18	0,6	0,85	1,2	1,5	1,7	1,9
63	0,04	0,063	0,2	0,63	0,9	1,25	1,6	1,8	2
80	0,063	0,1	0,22	0,67	0,95	1,3	1,7	1,9	2,1
100	0,1	0,16	0,25	0,71	1	1,4	1,8	2	2,2
125	0,16	0,25	0,28	0,75	1,05	1,5	1,9	2,1	2,4
160	0,25	0,4	0,32	0,8	1,1	1,6	2	2,2	2,5
200	0,4	0,63	0,42	1	1,4	2	2,5	2,8	3,2
250	0,56	1	0,56	1,25	1,8	2,5	3,2	3,6	4
320	0,75	1,6	0,75	1,6	2,2	3,2	4	4,5	5
400	1	2	1	2	2,8	4	5	5,6	6,3
500	1,3	2,5	1,3	2,5	3,6	5	6,3	7,1	8
630	1,8	3,2	1,8	3,2	4,5	6,3	8	9	10
800	2,4	4	2,4	4	5,6	8	10	11	12,5
1 000	3,2	5	3,2	5	7,1	10	12,5	14	16
1 250			4,2	6,3	9	12,5	16	18	20
1 600			5,6	8	11	16	20	22	25
2 000			7,5	10	14	20	25	28	32
2 500			10	12,5	18	25	32	36	40
3 200			12,5	16	22	32	40	45	50
4 000			16	20	28	40	50	56	63
5 000			20	25	36	50	63	71	80
6 300			25	32	45	63	80	90	100
8 000			32	40	56	80	100	110	125
10 000			40	50	71	100	125	140	160

a Material group I, II, IIIa and IIIb.
b Material group I, II and IIIa.

NOTE In accordance with 60664-1, the dimensions for creepage distance cannot be specified where permanently conductive pollution is present (Pollution degree 4).

6.1.4 Insulation resistance

The insulation resistance shall be not less than the values given in Table 3.

Table 3 – Insulation resistance

Measurement ^a			Resistance	Insulation
Supply circuit	to	welding circuit	5,0 MΩ	Double or reinforced
Welding circuit	to	protective circuit	2,5 MΩ	Basic
Supply circuit	to	protective circuit	2,5 MΩ	Basic
Supply circuit of Class II equipment	to	accessible surfaces ^b	5,0 MΩ	Double or reinforced
a Control circuits are tested together with the circuit to which they are galvanically connected.				
b For measurement to accessible non-conductive surfaces, such surfaces shall be considered to be covered by metal foil.				

Any control or auxiliary circuit connected to the protective conductor terminal shall be considered as an exposed conductive part for the purpose of this test.

Conformity shall be checked by the stabilized measurement of the insulation resistance by application of a d.c. voltage of 500 V at room temperature.

During the measurement, torches shall be disconnected, solid-state electronic components and their protective devices may be short-circuited and liquid cooling units shall be tested without liquid.

6.1.5 Dielectric strength

The insulation shall withstand the following test voltages without any flashover or breakdown:

- first test of a welding power source: test voltages given in Table 4;
- repetition of the test of the same welding power source: test voltage 80 % of the values given in Table 4.

Table 4 – Dielectric test voltages

Maximum rated voltage V r.m.s.	AC dielectric test voltage V r.m.s.			
	All circuits to exposed conductive parts, supply circuit to all circuits except the welding circuit		All circuits except supply circuit to welding circuit	Supply circuit to welding circuit
	Class I equipment	Class II equipment		
Up to 50	500	1 000	500	1 000
220	1 100	2 200	1 100	2 200
450	1 875	3 750	1 875	3 750
700	2 500	5 000	2 500	5 000
1 000	2 750	5 500	2 750	5 500

NOTE 1 The maximum rated voltage is valid for earthed and unearthed systems.

NOTE 2 In this document, the dielectric strength test of control circuits is limited to any circuit that enters or exits the enclosure apart from the supply circuit and the welding circuit.

a For intermediate values, interpolation is allowed on all supply networks (supply circuit) operating outside the range of 220 V to 450 V and on all three-phase, three-wire earthed systems without voltage exemption (see

Annex A).

b For intermediate values, interpolation is allowed on welding and control circuits.

The a.c. test voltage shall be of an approximate sine wave-form with a peak value not exceeding 1,45 times the r.m.s. value, having a frequency of approximately 50 Hz or 60 Hz.

The maximum permissible setting of the tripping current shall be 100 mA. The high voltage transformer shall deliver the prescribed voltage up to the tripping current. Tripping is regarded as a flashover or a breakdown.

NOTE For the operator's safety, the lowest setting of the tripping current (less than or equal to 10 mA) is typical.

Alternative test: A d.c. test voltage of 1,4 times the r.m.s. test voltage may be used.

Components or subassemblies shall not be disconnected or short-circuited unless the conditions of a), b) or c) below are met:

- a) The components or subassemblies are designed and tested to relevant standards that specify a voltage lower than the test voltage level of this document. These components or subassemblies are not connected between supply and welding circuits and their disconnection or short-circuiting does not prevent a part of that circuit from being tested. Example: fan motors and pump motors.
- b) The components or subassemblies are completely incorporated within either the supply or the welding circuit and their disconnection does not prevent a part of that circuit from being tested. Example: electronic circuits.
- c) Interference suppression networks or protection capacitors between the supply or welding circuit and any exposed conductive part conform to the relevant standards.

Control circuits connected to the protective conductor terminal shall not be disconnected during testing and they are then tested as exposed conductive parts.

At the discretion of the manufacturer, the test voltage may be slowly raised to the full value.

The test voltages between the supply circuit, the exposed conductive parts and the welding circuit may be applied simultaneously. An example is given in Annex B.

Engine-driven welding power sources shall undergo the same test.

Conformity shall be checked by application of the test voltage for

- a) 60 s (type test);
- b) 5 s (routine test);
- or
- c) 1 s (routine test with the test voltage increased by 20 %).

6.2 Protection against electric shock in normal service (direct contact)

6.2.1 Protection provided by the enclosure

Welding power sources specifically designed for indoor use shall have a minimum degree of protection of IP21S using IEC 60529 test procedures and conditions.

Welding power sources specifically designed for outdoor use shall have a minimum degree of protection of IP23S using IEC 60529 test procedures and conditions.

Welding power sources with degree of protection IP23S may be stored, but are not intended to be used outside during precipitation unless sheltered.

Adequate drainage shall be provided by the enclosure. Retained water shall not interfere with the operation of the equipment or impair safety. The quantity of water that enters the enclosure is not limited.

Welding circuit connections shall be protected as specified in 11.4.1.

Remote controls for welding power sources shall have a minimum degree of protection of IP2X using IEC 60529 test procedures and conditions.

Conformity shall be checked by the following test:

A welding power source shall be subjected to the appropriate water test without being energized. Immediately after the test, the welding power source shall be moved to a safe environment and subjected to the insulation resistance test, listed in 5.4 g) and dielectric strength test, listed in 5.4 h).

6.2.2 Capacitors

Each capacitor provided as part of a welding power source and connected either across a supply circuit or across a winding of a transformer providing welding current shall

- a) not contain more than 1 l of flammable liquid;
- b) be designed not to leak during normal service;
- c) be contained within the welding power source enclosure or other enclosure which conforms to the relevant requirements of this document.

Conformity shall be checked by visual inspection.

Capacitors shall not cause the welding power source to exhibit hazardous electrical breakdown or present risk of fire in event of a failure.

Conformity shall be checked by the following test:

The welding power source is operated at no-load at its rated supply voltage and with a supply fuse or circuit-breaker rated up to but not more than 200 % of the rated maximum supply current with all or any of the capacitors shorted until:

- 1) any fuse or over-current device in the welding power source has operated; or
- 2) the supply circuit fuse or circuit-breaker has cleared; or
- 3) the supply circuit components of the welding power source reach a steady state temperature, not higher than that allowed in 7.3.

If any undue heating or melting becomes apparent, the welding power source shall conform to the requirements of items a), c) and d) of 9.1.

There shall be no leakage of liquid during any of the type tests required by this document.

For interference suppression capacitors or capacitors having internal fusing or a circuit breaker, this test is not required.

6.2.3 Automatic discharge of supply circuit capacitors

Each capacitor shall be provided with a means of automatic discharge which shall reduce the voltage across the capacitor to 60 V or less within the time necessary to give access to any

current carrying part connected to the capacitor or an appropriate warning label shall be used. For any plug, which has a voltage due to a capacitor, the access time is considered to be 1 s.

Capacitors having a rated capacitance not exceeding 0,1 μF are not considered to present a risk of electric shock.

Conformity shall be checked by visual inspection and by the following test.

The welding power source is operated at the highest rated supply voltage. The welding power source is then disconnected from the supply network and the voltages are measured with instruments that do not significantly affect the values being measured.

6.2.4 Isolation of the welding circuit

The welding circuit shall be isolated from the supply circuit and from all other circuits having a voltage higher than the allowable no-load voltage in accordance with 11.1.1 (for example auxiliary power supply circuits) by reinforced or double insulation or equivalent means that meet the requirements of 6.1. If another circuit is connected to the welding circuit, the power of the other circuit shall be supplied by an isolating transformer or equivalent means.

The welding circuit shall not be connected internally to the connecting means for the external protective conductor, the enclosure, frame or core of the welding power source, except, if necessary, by an interference suppression network or protection capacitor.

Conformity shall be checked by tests given in 6.1.

6.2.5 Welding circuit touch current

The touch current between the welding circuit connections and the protective conductor terminal shall not exceed 14,1 mA peak.

Conformity shall be checked by visual inspection and measurement of the touch current with a circuit as shown in Figure 2 at the rated supply voltage(s) and no-load condition.

The measuring network specified in Figure N.1 shall be connected as shown in Figure 2.

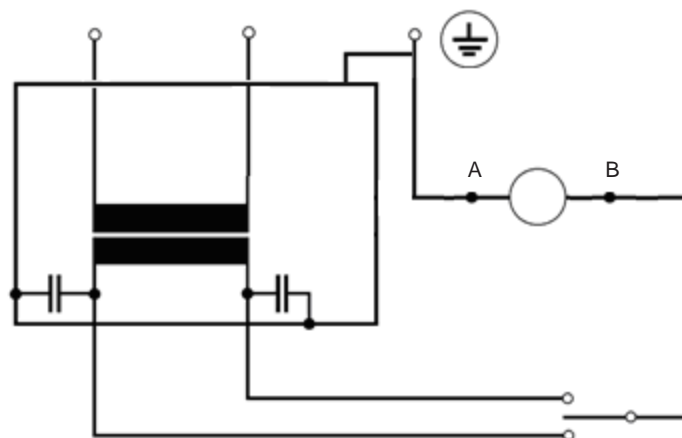

IEC 912/12

Key

A, B Measuring network connections

NOTE For class II equipment, use the PE-terminal of earthed supply network.

Figure 2 – Measurement of welding circuit touch current

6.2.6 Touch current in normal condition

The touch current for accessible conductive surfaces, not connected to the protective circuit, shall not exceed 0,7 mA peak under normal conditions.

Conformity shall be checked using the configurations as shown in Annex N, without simulating any fault and under the following conditions:

- a) the welding power source is:
 - isolated from the ground plane;
 - supplied by the highest rated supply voltage;
- b) the welding circuit is in the no-load condition;
- c) interference suppression capacitors are not disconnected.

6.3 Protection against electric shock in case of a fault condition (indirect contact)

6.3.1 Protective provisions

Welding power sources shall be class I or class II equipment in accordance with IEC 61140, with the exception of the welding circuit.

6.3.2 Isolation between windings of the supply circuit and the welding circuit

Windings of the supply circuit and the welding circuit shall be isolated by

- a) reinforced or double insulation
or
- b) basic insulation to a metal screen between them which is connected to the protective conductor.

Between the windings of the supply circuit and the welding circuit, there shall be insulation which conforms to the values given in Table 5.

Table 5 – Minimum distance through insulation

Rated supply voltage V r.m.s.	Minimum distance through insulation mm	
	Single layer	Total of three or more separate layers
up to 440	1,3	0,35
441 to 690	1,5	0,4
691 to 1 000	2,0	0,5

Where there is a metal screen between the windings, the thickness of the insulation between each winding and the screen shall be at least half the values given in Table 5.

Conformity shall be checked by visual inspection and by measurement.

6.3.3 Internal conductors and connections

Internal conductors and connections shall be secured or positioned to prevent accidental loosening, which could cause electrical connection between

- a) the supply circuit or any other circuit and the welding circuit so that the output voltage could become higher than the allowable no-load voltage;
- b) the protective conductor, enclosure, frame or core and the welding circuit.

Where insulated conductors pass through metallic parts, they shall be provided with bushings of insulating material or the openings shall be smoothly rounded with a radius of at least 1,5 mm.

Bare conductors shall be so fixed that the clearance and creepage distance from each other and from conductive parts is maintained (see 6.1.2 and 6.3.2).

Conductors of different circuits may be laid side by side, may occupy the same duct (for example conduit, cable trunking system), or may be in the same multi-conductor cable provided that the arrangement does not impair the proper functioning of the respective circuits. Where those circuits operate at different voltages, the conductors shall be separated by suitable barriers or shall be insulated for the highest voltage to which any conductor within the same duct can be subjected.

Conformity shall be checked by visual inspection and by measurement.

6.3.4 Additional requirements for plasma cutting systems

The plasma cutting torch, parts (e.g. parts typically replaced due to wear) and plasma cutting power source, recommended by the manufacturer, shall form a safe system.

Plasma tips, which for technical reasons cannot be protected against direct contact, shall be considered sufficiently protected for normal use and single-fault condition if the following requirements are fulfilled:

a) when no arc current is present:

the voltage between the plasma tip and the workpiece and/or earth is not higher than the values given in 11.1.1,

or

the plasma cutting power source is fitted with a hazard reducing device in accordance with Clause 13,

and

b) for manual systems, when an arc current is present:

the sides of a plasma tip cannot be touched by the standard test finger in accordance with IEC 60529 when it is placed on a flat surface with its centre line perpendicular to it,

or

the d.c. load voltage between the plasma tip and the workpiece and/or earth is not higher than values given in 11.1.1.

NOTE A single-fault is an abnormal condition resulting from the electrode being in contact with the plasma tip because of missing insulators, sticking of the plasma tip to the electrode, conductive material between plasma tip and electrode, wrong parts, loose parts, electrode abrasion, parts inserted incorrectly, excessive load or incorrect gas flow.

Conformity shall be tested in accordance with 11.1 and by simulating a torch fault and testing in accordance with Clause 13. The torch shall be tested in accordance with IEC 60974-7.

6.3.5 Movable coils and cores

If movable coils or cores are used to adjust the welding current, the construction shall be such that the prescribed clearances and creepage distances are maintained, taking into account electrical and mechanical stresses.

Conformity shall be checked by operating the mechanism 500 times over its complete movement between minimum and maximum at the rate specified by the manufacturer and by visual inspection.

6.3.6 Touch current in fault condition

For class 1 equipment, the weighted touch current in the case of an external protective conductor failure or disconnection shall not exceed:

- a) 7 mA peak for plug-connected equipment rated up to and including 32 A effective supply current;
- b) 14,1 mA peak for plug-connected equipment rated more than 32 A effective supply current;
- c) 14,1 mA peak for equipment for permanent connection, without special measures for the protective conductor.

Equipment for permanent connection with a reinforced protective conductor may have a leakage current up to 5 % of the rated supply current per phase.

The following shall be provided for the reinforced protective conductor:

- a connection terminal assigned for the connection of a protective conductor measuring at least 10 mm² Cu or 16 mm² Al, or
- a second terminal designed for the connection of a protective conductor of the same cross-section as that of the normal protective conductor.

Conformity shall be checked using the configurations as shown in Annex N under the following conditions:

- 1) the welding power source is:
 - isolated from the ground plane;
 - supplied by the highest rated supply voltage;
 - not connected to the protective earth except through measurement components;
- 2) the welding circuit is in the no-load condition;
- 3) interference suppression capacitors shall not be disconnected.

7 Thermal requirements

7.1 Heating test

7.1.1 Test conditions

When placing the measuring devices, the only access permitted shall be through openings with cover plates, inspection doors or easily removable panels provided by the manufacturer. The ventilation in the test area and the measuring devices used shall not interfere with the normal ventilation of the welding power source or cause abnormal transfer of heat to or from it.

The welding power source is operated at rated supply voltage, with constant current, at a cycle time of (10 ± 0,2) min:

- a) with the rated welding current (I_2) at 60 % and/or 100 % duty cycle as appropriate;
- b) with the rated maximum welding current (I_{2max}) at the corresponding duty cycle.

If it is known that neither a) nor b) gives maximum heating, then a test shall be made at the setting within the rated range which gives the maximum heating.

In the case of a welding power source rated for a.c. tungsten inert-gas welding, an unbalanced load could cause maximum heating. In this case, a test shall be carried out as given in Annex C.

The ambient temperature condition of 5.1 shall be fulfilled.

NOTE 1 This maximum heating is possible at the no-load condition.

NOTE 2 The tests, if relevant, follow each other without having the welding power source returned to the ambient air temperature.

7.1.2 Tolerances of the test parameters

During the last 60 min of the heating test in accordance with 7.1.3, the following tolerances shall be met:

- a) load voltage: $\begin{matrix} +10 \\ -2 \end{matrix}$ % of the appropriate conventional load voltage;
- b) welding current: $\begin{matrix} +10 \\ -2 \end{matrix}$ % of the appropriate conventional welding current;
- c) supply voltage: ± 5 % of the appropriate rated supply voltage;
- d) engine speed: ± 5 % of the appropriate rated speed;
- e) temperature: $\begin{matrix} +10 \\ -2 \end{matrix}$ K of the ambient temperature.

7.1.3 Duration of test

The heating test shall be carried out until the rate of the temperature rise does not exceed 2 K/h on any component for a period not less than 60 min.

7.2 Temperature measurement

7.2.1 Measurement conditions

The temperature shall be determined at the midpoint of the load time of the last cycle as follows:

- a) for windings, by measurement of the resistance, or by surface or embedded temperature sensors;

NOTE 1 The surface temperature sensor method is not preferred.

NOTE 2 In the case of windings of low resistance having switch contacts in series with them, the resistance measurement can give misleading results.

- b) for other parts, by surface temperature sensors.

7.2.2 Surface temperature sensor

The temperature is measured by a temperature sensor applied to accessible surfaces of windings or other parts in accordance with the conditions stipulated below.

NOTE 1 Typical temperature sensors are thermocouples, resistance thermometers, etc.

Bulb thermometers shall not be used for measuring temperatures of windings and surfaces.

Temperature sensors are placed at accessible spots where the maximum temperature is likely to occur. It is advisable to locate the predictable hot spots by means of a preliminary check.

NOTE 2 The size and spread of hot spots in windings depend on the design of the welding power source.

Efficient heat transmission between the point of measurement and the temperature sensor shall be ensured, and protection shall be provided for the temperature sensor against the effect of air currents and radiation.

7.2.3 Resistance

The temperature rise of windings is determined by the increase in their resistance and is obtained for copper by the following formula:

$$t_2 - t_a = \frac{(235 + t_1)(R_2 - R_1)}{R_1} + (t_1 - t_a)$$

where

t_1 is the temperature of the winding at the moment when R_1 is measured (°C);

t_2 is the calculated temperature of the winding at the end of the test (°C);

t_a is the ambient air temperature at the end of the test (°C);

R_1 is the initial resistance of the winding (Ω);

R_2 is the resistance of the winding at the end of the test (Ω).

For aluminium, the number 235 in the above formula is replaced by the number 225.

The temperature t_1 shall be within ± 3 K of the ambient air temperature.

7.2.4 Embedded temperature sensor

The temperature is measured by thermocouples or other suitable temperature measuring instruments of comparable size embedded at the hottest parts.

Thermocouples shall be applied directly to windings and coils. Any integrally applied insulation on the conductors themselves is not required to be removed.

A thermocouple applied to the hottest point of a single layer winding is considered as embedded.

7.2.5 Determination of the ambient air temperature

The ambient air temperature is determined by at least three measuring devices. These are spaced uniformly around the welding power source, at approximately one-half of its height and 1 m to 2 m from its surface. They are protected from draughts and abnormal heating. The mean value of the temperature readings is adopted as the temperature of the ambient air.

In the case of forced air-cooled welding power sources, a single measuring device is placed where the air enters the cooling system. The mean of the readings taken at equal intervals of time during the last quarter of the duration of the test is adopted as the ambient air temperature.

7.2.6 Recording of temperatures

Where possible, temperatures are recorded while the equipment is in operation and after shutdown. On those parts where the recording of temperature is not possible while the equipment is in operation, temperatures are taken after shutdown as described below.

Whenever a sufficient time has elapsed between the instant of shutdown and the time of final temperature measurement to permit the temperature to fall, suitable corrections are applied to obtain as nearly as practicable the temperature at the instant of shutdown. This may be done by plotting a curve in accordance with Annex D. A minimum of four temperature readings is taken within 5 min from shutdown. In cases where successive measurements show an increasing temperature after shutdown, the highest value is taken.

To maintain the temperature during the stopping period, precautions shall be taken to shorten the stopping period of an engine-driven welding power source.

7.3 Limits of temperature rise

7.3.1 Windings, commutators and slip-rings

The temperature rise for windings, commutators and slip-rings shall not exceed the values given in Table 6, regardless of the method of temperature measurement used.

Table 6 – Temperature limits for windings, commutators and slip-rings

Class of insulation	Maximum temperature °C	Maximum temperature rise K			
		Windings			Commutators and slip-rings
°C	°C	Surface temperature sensor	Resistance	Embedded temperature sensor	
105 (A)	150	55	60	65	60
120 (E)	165	70	75	80	70
130 (B)	175	75	80	90	80
155 (F)	190	95	105	115	90
180 (H)	210	115	125	140	100
200 (N)	230	130	145	160	Not determined
220 (R)	250	150	160	180	

NOTE 1 Surface temperature sensor means that the temperature is measured with non-embedded sensors at the hottest accessible spot of the outer surface of the windings.

NOTE 2 Normally, the temperature at the surface is the lowest. The temperature determined by resistance measurement gives the average between all temperatures occurring in a winding. The highest temperature occurring in the windings (hot spot) can be measured by embedded temperature sensors.

NOTE 3 Other classes of insulation having higher values than those given in Table 6 are available (see IEC 60085).

No part shall be allowed to reach any temperature that will damage another part even though that part might conform to the requirements in Table 6.

Furthermore, for tests at other than 100 % duty cycle, the temperature occurring during any full cycle shall not exceed the maximum temperatures given in Table 6.

Conformity shall be checked by measurement in accordance with 7.2.

7.3.2 External surfaces

The temperature rise for external surfaces shall not exceed the values given in Table 7. Limits of temperature rise are given for:

- an unintentional contact period of 1 s for enclosures,
- a contact period of 4 s for buttons and
- a contact period of 60 s for handles.

Table 7 – Temperature limits for external surfaces

External surface	Maximum temperature rise K	Burn threshold for contact period ^a s
Uncoated metal enclosures	25	1
Painted metal enclosures	35	1
Plastic enclosures	45	1
Uncoated metal buttons	18	4
Painted metal buttons	22	4
Plastic buttons	35	4
Metal handles	10	60
Plastic handles	20	60

^a Informative values in accordance with ISO 13732-1.

For engine-driven power sources, the limits of Table 7 may be exceeded for surfaces that are:

- a) recognizable by appearance or function; or
- b) marked with the symbol IEC 60417-5041 ; or
- c) located or guarded to prevent unintentional contact during normal operation.

NOTE Surfaces that are recognizable by appearance or function include parts such as exhaust parts, silencers, spark arrestors, or cylinder heads.

Conformity shall be checked by measurement in accordance with 7.2 and visual inspection.

7.3.3 Other components

The maximum temperature of other components shall not exceed their rated maximum temperature, in accordance with the relevant standard.

7.4 Loading test

Welding power sources shall withstand repeated load cycles without damage or functional failure. This test may be conducted on any welding power source that functions correctly.

Conformity shall be checked by the following tests and by establishing that no damage or functional failure to the welding power source occur during the tests.

Starting from the cold state, the welding power source is loaded at the rated maximum welding current until one of the following occurs:

- a) the thermal protection is actuated;
- b) the maximum temperature limit of the windings is reached;
- c) a period of 10 min is reached.

Immediately after reset of the thermal protection in a), or after b) or c), one of the following tests is carried out.

- 1) In the case of a drooping characteristic welding power source, the controls are set to provide rated maximum welding current. It is then loaded 60 times with a short circuit having an external resistance between 8 mΩ and 10 mΩ for 2 s, followed by a pause of 3 s.
- 2) In the case of a flat characteristic welding power source, it is loaded once with 1,5 times the rated maximum welding current at maximum available load voltage for 15 s. For welding power sources fitted with a protection device, which limits the welding current to a value

lower than 1,5 times the rated maximum welding current, the test is carried out at the maximum welding current available at corresponding load voltage.

Immediately after test 1) or 2) is carried out, while equipment is still hot, the equipment shall be checked in accordance with 6.1.5.

7.5 Commutators and slip-rings

Commutators, slip-rings and their brushes shall show no evidence of injurious sparking or damage throughout the range of the engine-driven welding power source.

Conformity shall be checked by visual inspection during

- a) the heating test in accordance with 7.4.1 and
- b) the loading test in accordance with item 1) or 2) of 7.4.

8 Thermal protection

8.1 General requirements

An electrically powered welding power source shall be fitted with thermal protection if the duty cycle at rated maximum welding current is lower than

- a) 35 % in the case of a drooping characteristic
or
- b) 60 % in the case of a flat characteristic.

NOTE A drooping characteristic is generally used for manual metal arc welding and tungsten inert gas welding, while a flat characteristic is generally used for metal inert/active gas welding.

If a welding power source is fitted with thermal protection, the thermal protection shall meet the requirements of 8.2 to 8.7.

Conformity shall be checked by visual inspection.

8.2 Construction

The thermal protection shall be designed to prevent alteration of the temperature setting or operation.

Conformity shall be checked by visual inspection.

8.3 Location

The thermal protection shall be permanently located within the welding power source to ensure that the heat transfer is reliable.

Conformity shall be checked by visual inspection.

8.4 Operating capacity

The thermal protection shall be able to operate, when the welding power source delivers its rated maximum welding current:

- a) 100 times, in the case of a duty cycle of 35 % or higher
or

b) 200 times, in the case of a duty cycle lower than 35 %.

Conformity shall be checked with a suitable overload producing the required number of consecutive interruptions of a circuit having the same electrical characteristics, especially current and reactance, as the circuit in which the thermal protection is used.

After this test, the requirements of 8.4 and 8.6 shall be met.

8.5 Operation

The thermal protection shall prevent the welding power source windings from exceeding the maximum temperature limits given in Table 6.

The thermal protection shall not operate when the welding power source is loaded with the rated maximum welding current at the corresponding rated duty cycle indicated on the rating plate.

Conformity shall be checked during operation in accordance with 7.1, at rated maximum welding current, at ambient temperature condition of 5.1 and without operation of the thermal protection. After that, the welding power source is overloaded in accordance with 9.4. Additionally, if the temperature condition of 5.1 does not give the maximum heating of windings, the test shall be carried out at ambient temperature that gives the maximum heating of windings.

8.6 Resetting

The thermal protection shall not reset automatically or manually until the temperature has dropped below that of the class of insulation given in Table 6.

Conformity shall be checked by operation and temperature measurement.

8.7 Indication

Welding power sources fitted with thermal protection shall indicate that the thermal protection has reduced or disconnected the welding power source output. When the thermal protection has an automatic reset, the indicator shall be either a yellow light (or yellow flag within an aperture), or an alphanumeric display showing symbols or words whose meanings are given in the instruction manual.

Conformity shall be checked by visual inspection.

9 Abnormal operation

9.1 General requirements

A welding power source shall not breakdown and increases the risk of electric shock or fire, under the conditions of operation of 9.2 to 9.4. These tests are conducted without regard to temperature attained on any part, or the continued proper functioning of the welding power source. The only criterion is that the welding power source does not become unsafe. These tests may be conducted on any welding power sources that function correctly.

Welding power sources, protected internally by, for example, circuit-breaker or thermal protection, meet this requirement if the protection device operates before an unsafe condition occurs.

Conformity shall be checked by the following tests:

a) A layer of dry absorbent surgical type cotton is placed under the welding power source, extending beyond each side for a distance of 150 mm.

- b) Starting from the cold state, the welding power source is operated in accordance with 9.2 to 9.4.
- c) During the test, the welding power source shall not emit flames, molten metal or other materials that ignite the cotton indicator.
- d) Following the test and not more than 5 min after the test, the welding power source shall be capable of withstanding a dielectric test in accordance with 6.1.5 b).

9.2 Stalled fan test

A welding power source, which relies on motor-driven fans for conformity with the tests of Clause 7, is operated at rated supply voltage or rated load speed for a period of 4 h while the fan motor(s) is(are) mechanically stalled and the welding power source operated at the output condition of 7.1.

NOTE The intention of this test is to run the welding power source with the fan stationary to check the safety of both the fan and the welding power source.

9.3 Short circuit test

The welding power source is short circuited with the torch and the welding cables normally supplied by the manufacturer, or, if none are supplied, by a conductor 1,2 m in length and of the cross-section given in Table 8.

NOTE Cross sections for non-SI system are given in Table F.1

The welding power source at the maximum output setting is connected to that rated supply voltage that produces the highest rated supply current at rated maximum welding current. The supply circuit is protected by external fuses or a circuit-breaker with the rating and type as specified by the manufacturer.

Table 8 – Cross-section of the output short-circuit conductor

Rated maximum welding current A	Minimum cross-section ^a mm ²
Up to 199	25
200 to 299	35
300 to 499	50
500 and above	70

^a See Annex F.

The welding power source shall not clear the supply fuse or circuit breaker when short circuited:

- a) for 15 s in the case of a drooping characteristic;
- b) three times for 1 s, within a period of 1 min, in the case of a flat characteristic.

The short circuit is then applied for 2 min or until the supply fuse or circuit breaker clears.

The supply voltage shall not decrease by more than 10 % during this test.

Mechanically driven welding power sources are short circuited for 2 min at maximum output setting and set for operation at rated load speed.

9.4 Overload test

The welding power source is operated for 4 h in accordance with 7.1.1 b) at 1,5 times the corresponding duty cycle.

If the welding power source is rated for more than 67 % duty cycle, this test is conducted at 100 % duty cycle.

If the welding power source is provided with output regulating taps, those taps producing the highest supply current shall be used.

If the duty cycle at the rated maximum welding current is 100 %, the welding power source need not be tested.

10 Connection to the supply network

10.1 Supply voltage

Welding power sources shall be capable of operating at the rated supply voltage $\pm 10\%$. This may give deviations from the rated values.

Conformity shall be checked by the following test:

The welding power source is connected to a conventional load and adjusted to minimum and maximum output. Each setting is tested at rated supply voltage $\pm 10\%$. Verify presence of stable current flow in the welding circuit under these four conditions.

10.2 Multi-supply voltage

Welding power sources which are designed to operate from different supply voltages shall be fitted with one of the following:

- a) an internal voltage selection panel where the adjustment for the supply voltage is made by links. A marking shall indicate the arrangement of links for each supply voltage;
- b) an internal terminal box or panel in which the terminals are clearly marked with the supply voltages;
- c) a switch for tap selection which shall be fitted with an interlocking system which prevents the switch being moved to an incorrect position. The interlocking system shall be adjusted only by the use of a tool;
- d) two supply cables, each fitted with a different plug, and a selector switch which ensures that the pins of the plug not in use cannot become live;
- e) a system to automatically configure the welding power source in accordance with the supply voltage.

NOTE Welding power sources can be fitted with an external indication of the supply voltage selected.

Conformity shall be checked by visual inspection and the following tests.

In the case d), a selector switch is additionally tested in accordance with 10.8.

10.3 Means of connection to the supply circuit

Acceptable means of connection to the supply circuit are one of the following:

- a) terminals intended for the permanent connection of flexible supply cables;
- b) terminals intended for the connection of supply cables to a permanent installation;
- c) appliance inlets fitted to the welding power source.

NOTE This requirement can also be met by using terminals on a device such as a switch, contactor, etc.

The means of connection to the supply circuit shall be chosen in accordance with the maximum effective supply current $I_{1\text{eff}}$ and the maximum supply voltage and meet the requirements of the relevant standards or be designed in accordance with Annex E.

Conformity shall be checked by visual inspection.

10.4 Marking of terminals

The terminal for the external protective conductor shall be marked with the symbol  (IEC 60417-5019).

Optionally the following may be added:

- a) the letters: **PE**
or
- b) the twin colours: **green and yellow**.

Additionally, three-phase equipment terminals shall be clearly marked in accordance with IEC 60445 or other relevant component standards. The identifying marking notation shall be located on or adjacent to the corresponding terminal.

Conformity shall be checked by visual inspection.

10.5 Protective circuit

10.5.1 Continuity requirement

The internal protective circuit shall be capable of withstanding currents likely to be encountered in the case of a fault.

Class I welding power sources shall have a suitable terminal, adjacent to the phase-conductor terminals, dimensioned in accordance with Annex E and Table E.1, for the connection of the external protective conductor. This terminal shall not be used for any other purpose (such as for clamping two parts of the casing together).

On and inside the welding power source, if there is a neutral-conductor terminal, this shall not be in electrical contact with the terminal for the connection of the protective conductor.

Both inside and outside the welding power source, insulated protective conductors shall have the twin colours green and yellow. If the welding power source is supplied with a flexible multi-conductor supply cable, this shall have the protective conductor with the twin colours green and yellow.

In some countries, the single colour green is also used to identify the protective conductor and the protective conductor terminal.

If the welding power source is fitted with a protective conductor, it shall be connected in such a way that if the cable is pulled away from the terminals, the phase conductors break before the protective conductor.

Conformity shall be checked by visual inspection and the tests given in 10.5.2 and 10.5.3.

The method of securing conductive parts to the protective circuits, for example paint-piercing washers, paint-piercing screws or non-painted surfaces shall be considered during visual inspection.

10.5.2 Type test

A current of 200 % of the maximum effective supply current as given on the rating plate is applied from an enclosure part, that is likely to become live, through the external protective conductor terminal for a period of time given in Table 9, using the smallest external protective conductor size given in Table 10.

NOTE The waveform of the test current is not defined as long as the effective value is used for comparison.

Table 9 – Current and time requirements for protective circuits

Current A	Time min
Up to 30	2
31 to 60	4
61 to 100	6
101 to 200	8
Above 200	10

Table 10 – Minimum cross-sectional area of the external protective copper conductor

Cross-sectional area of phase conductors supplying the equipment S mm ²	Minimum cross-sectional area of the external protective copper conductor S_p mm ²
$S \leq 16$	S
$16 < S \leq 35$	16
$S > 35$	$S/2$

During the test there shall be no melting of any metal, deterioration of the bond to the welding power source, nor heating likely to cause a fire, nor shall the measured voltage drop from the enclosure part to the terminal exceed 4 V r.m.s.

10.5.3 Routine test

The test is to verify the continuity of the protective circuit by injecting a current of at least 10 A at 50 Hz or 60 Hz derived from a SELV source. The tests are to be made between the PE terminal and relevant points that are part of the protective circuit. The test time is 1 s.

The measured voltage between the PE terminal and the points of test shall not exceed the values given in Table 11:

Table 11 – Verification of continuity of the protective circuit

Minimum effective protective conductor cross-sectional area of the branch under test mm ²	Maximum measured voltage drop (values are given for a test current of 10 A) V
1,0	3,3
1,5	2,6
2,5	1,9
4,0	1,4
> 6,0	1,0

10.6 Cable anchorage

Welding power sources fitted with terminals for the connection of flexible supply cables shall be provided with a cable anchorage that relieves the electrical connection from strain.

The cable anchorage shall be so constructed that

- a) it is dimensioned for flexible cables having the range of cross-sectional area of conductor as specified in Table E.1;
- b) the method of anchorage can be easily recognized;
- c) the cable can be easily replaced;
- d) the cable cannot come into contact with conductive clamping screws of the cable anchorage if these screws are accessible or in electrical contact with exposed conductive parts;
- e) the cable is not retained by a metal screw which bears directly on it;
- f) at least one part of the cable anchorage is securely fixed to the welding power source;
- g) any screws that need to be loosened or tightened during cable replacement do not serve to fix any other component;
- h) when fitted to a class II welding power source, it shall be made of insulating material or so insulated that, if there is a cable insulation fault, no exposed conductive parts shall become live.

Conformity shall be checked by visual inspection and by the following test.

A flexible supply cable, which has the minimum cross-sectional area of the conductor specified, is connected at the point of connection to the equipment. The cable anchorage is fitted to the cable and tightened.

It shall then not be possible to push the cable so far into the welding power source that either the cable itself or internal parts of the welding power source are likely to be damaged.

The cable anchorage is then loosened and retightened 10 times.

The cable is then subjected for 1 min to a pull as specified in Table 12 without jerking.

Table 12 – Pull

Nominal cross-sectional area of the conductor mm ²	Pull N
1,5	150
2,5	220
4,0	330
6 and above	440

At the end of the test, the cable shall not have been displaced by more than 2 mm and the ends of the conductors shall not have been noticeably displaced in the terminals. To measure the displacement, prior to the test, a mark is provided at a distance of 20 mm from the cable anchorage on the cable with the cable in the stressed condition.

After the test, the displacement of this mark in relation to the cable anchorage is measured, with the cable in the stressed condition.

During the test, no visible damage (for example nicks, cuts or tears in the sheath) shall be caused to the cable.

The test is then repeated with the maximum cross-sectional area of the conductor specified.

10.7 Inlet openings

Where the supply cable passes through metallic parts, it shall be provided with a bushing of insulating material, or the openings shall be smoothly rounded with a radius of at least 1,5 mm.

Conformity shall be checked by visual inspection.

10.8 Supply circuit on/off switching device

Where a built-in supply circuit on/off switching device (for example switch, contactor or circuit-breaker) is provided, this shall:

- a) switch all ungrounded mains conductors, and
- b) plainly indicate whether the circuit is open or closed, and either
- c) be rated as follows:
 - voltage: not less than the values given on the rating plate,
 - current: not less than the highest effective supply current as given on the rating plate,or
- d) be suitable for this application.

Conformity shall be checked by visual inspection; for c) in accordance with other relevant standards, and for d) by the following tests.

For the tests, the supply circuit on/off switching devices may be mounted external to the power source.

A welding power source is connected for the rated supply voltage that corresponds to the rated maximum supply current and, in addition for class I equipment, a fuse of 10 A to 20 A is placed

- in the case of an earthed supply circuit, in the protective earth connection;

- in the case of an unearthed supply circuit, between a phase conductor and the protective circuit.

During the tests, the supply voltage shall be maintained at not less than at the rated value.

Overload: The output of the welding power source is short-circuited in accordance with 9.3. The switching device is operated for 100 cycles at the rate of 6 to 10 cycles per minute with a minimum on-time of 1 s.

A switching device need not be tested if its rated value exceeds twice the rated maximum supply current of the welding power source.

Endurance: The output is connected to a conventional load and adjusted to produce the rated welding current at 100 % duty cycle. The switching device is operated for 1 000 cycles at a rate of 6 to 10 cycles per minute with a minimum on-time of 1 s.

A welding power source with more than one rated supply voltage is also tested at the rated maximum supply voltage.

There shall be no electrical or mechanical failure and, in addition for class I equipment, no clearing of the fuse.

NOTE A component having demonstrated that it passes these tests can be used in other similar applications if the other requirements are equal or less.

10.9 Supply cables

When supply cables are attached to the welding power source, they shall:

- a) be suitable for the application and meet national and local regulations;
- b) be dimensioned in accordance with the maximum effective supply current $I_{1\text{eff}}$; and
- c) have a length of at least 2 m as measured from the exit point of the enclosure.

Conformity shall be checked by visual inspection.

NOTE Examples of local regulations are given in the Bibliography, e.g. HD 22.1 S4, Electrical code NFPA 70 (SE, SO, ST, STO or other extra hard usage cable) or CSA C22.1. PVC insulation has been proven not suitable for the application.

10.10 Supply coupling device (attachment plug)

If a supply coupling device is provided as a part of the arc welding equipment, its rated values shall be not less than:

- a) the rated current of the fuse required to comply with the tests specified in 9.3 regardless of whether or not an supply circuit switch is incorporated;
- b) the maximum effective supply current $I_{1\text{eff}}$.

For supply networks up to 125 V, the rated current shall, additionally, not be less than either c) or d):

- c) 70 % of the rated maximum supply current for equipment incorporating a supply switch;
- d) 70 % of the supply current measured with the output short-circuited at maximum setting for equipment not incorporating a supply switch.

Furthermore, the coupling device shall be suitable for industrial purposes.

NOTE Example of coupling devices suitable for industrial purposes can be found in IEC 60309-1.

Conformity shall be checked by visual inspection, measurement and calculation.

11 Output

11.1 Rated no-load voltage

11.1.1 Rated no-load voltage for use in environments with increased risk of electric shock

If the welding power source is not fitted with a hazard reducing device in accordance with Clause 13, the rated no-load voltage shall not exceed:

- a) d.c. 113 V peak;
- b) a.c. 68 V peak and 48 V r.m.s.

Such welding power sources may be marked with the symbol 84 of Annex L.

Conformity shall be checked by measurement and by analysis of the circuit and/or by failure simulation in accordance with 11.1.5.

11.1.2 Rated no-load voltage for use in environments without increased risk of electric shock

If the welding power source is not fitted with a hazard reducing device in accordance with Clause 13, the rated no-load voltage shall not exceed

- a) d.c. 113 V peak;
- b) a.c. 113 V peak and 80 V r.m.s.

Conformity shall be checked by measurement in accordance with 11.1.5.

11.1.3 Rated no-load voltage for the use with mechanically held torches with increased protection for the operator

The rated no-load voltage shall not exceed

- a) d.c. 141 V peak;
- b) a.c. 141 V peak and 100 V r.m.s.

These values may only be used if the following requirements are fulfilled:

- c) the torch shall not be hand-held;
- d) the no-load voltage shall be switched off automatically when the welding is stopped;
and
- e) the protection against direct contact with live parts shall be given by:
 - a minimum degree of protection of IP2X,
or
 - a hazard reducing device (see Clause 13).

Conformity shall be checked by measurement in accordance with 11.1.5, by operation and by visual inspection.

11.1.4 Rated no-load voltage for special processes for example plasma cutting

The rated no-load voltage shall not exceed 500 V peak d.c.

Conformity shall be checked by measurement in accordance with 11.1.5, by operation and by visual inspection, except that the series combination of the 200 Ω fixed and 5 k Ω variable resistors may be replaced by a fixed resistance of 5 k Ω .

A rated no-load voltage exceeding 113 V peak d.c. may only be used if the following requirements are fulfilled.

- a) These plasma cutting power sources with their corresponding torches shall prevent the output of no-load voltage if the torch is disassembled or disconnected from the plasma cutting power source.
- b) The no-load voltage shall be less than 68 V peak not later than 2 s after the control circuit (for example start switch) is opened.
- c) The voltage between the tip of the torch and the workpiece or earth shall be less than 68 V peak not later than 2 s after both pilot and main arcs are extinguished.

The conditions for complying with these requirements shall be given in the instructions.

Such plasma cutting power sources may be marked with the symbol 84 of Annex L.

Conformity shall be checked by measurement by meter or oscilloscope in parallel with 5 k Ω minimum resistance.

11.1.5 Additional requirements

The rated no-load voltage at all possible output settings shall not exceed the values given in 11.1.1 to 11.1.4, summarized in Table 13.

During measurement, the actual supply voltage shall not vary from the rated supply voltage by greater than $\pm 6\%$. If the no-load voltage varies with supply voltage, then for a variation of supply voltage greater than $\pm 1\%$, the no-load voltage shall be linearly corrected in accordance with the actual supply voltage.

Table 13 – Summary of allowable rated no-load voltages

Subclause	Working conditions	Rated no-load voltage
11.1.1	Environment with increased risk of electric shock	d.c. 113 V peak a.c. 68 V peak and 48 V r.m.s.
11.1.2	Environment without increased risk of electric shock	d.c. 113 V peak a.c. 113 V peak and 80 V r.m.s.
11.1.3	Mechanically held torches with increased protection for the operator	d.c. 141 V peak a.c. 141 V peak and 100 V r.m.s.
11.1.4	Plasma cutting	d.c. 500 V peak

Welding power sources shall be

- a) designed to ensure that the output voltages given in Table 13 are not exceeded in the event of failure of any component (for example, open circuit or short circuit failure)
or
- b) fitted with a protection system, which switches off the voltage at the output terminals within 0,3 s and shall not be reset automatically.

These values are not applicable to voltages for arc striking or arc stabilizing that could be superimposed.

Conformity shall be checked by measurement and by analysis of the circuit and/or by failure simulation.

11.1.6 Measuring circuits

For measuring r.m.s. values, a true r.m.s. meter shall be used together with a resistor of $5 \pm 5\%$ k Ω , connected across the welding circuit terminals as shown in Figure 3.

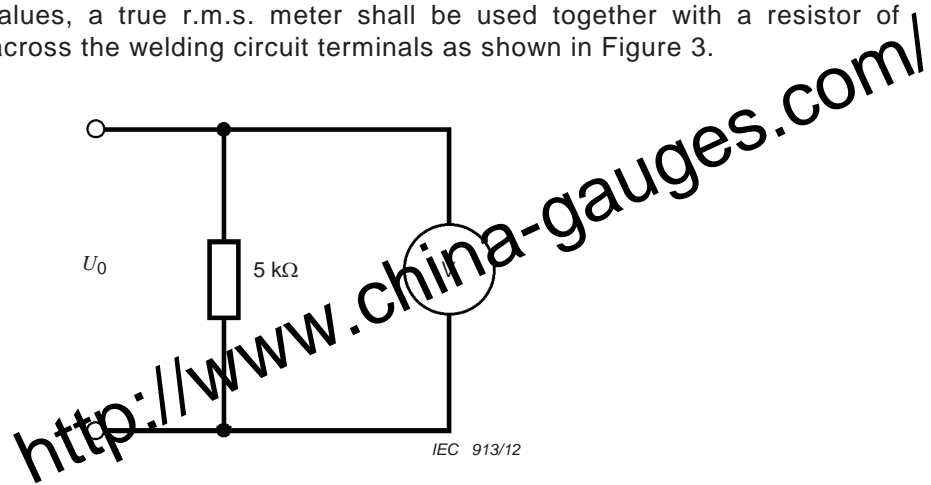

Key

- U_0 No-load voltage
- V True r.m.s. voltmeter

Figure 3 – Measurement of r.m.s. values

To obtain reproducible measurements of peak values, omitting impulses which are not dangerous, a circuit as shown in Figure 4 shall be used.

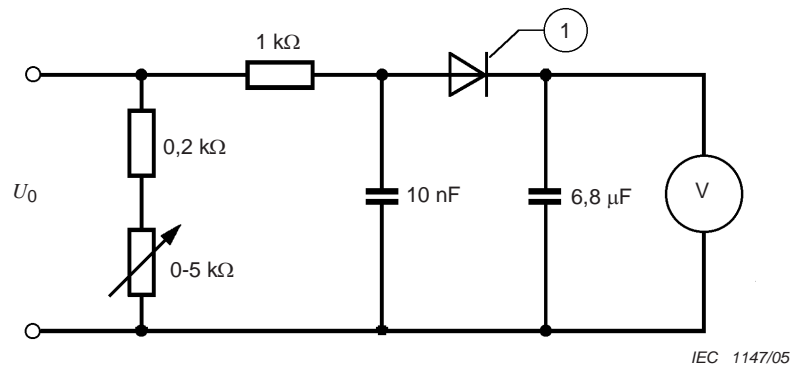

Key

- U_0 No-load voltage
- V Voltmeter
- 1 Diode 1N4007 or similar

Figure 4 – Measurement of peak values

The voltmeter shall indicate mean values. The measurement range chosen shall be as near as possible to the actual value of the no-load voltage. The voltmeter shall have an internal resistance of at least 1 M Ω .

The tolerance of the component values in the measurement circuit shall not exceed $\pm 5\%$.

For the type test, the rheostat is varied from 0 Ω to 5 k Ω in order to obtain the highest peak value of the voltage measured with these loads of 200 Ω to 5,2 k Ω . This measurement is repeated with the two connections to the measuring apparatus reversed.

The rheostat resistance and connection that produces the highest value of the voltage may be determined during the type test. This resistance and lead polarity may be used for the routine test.

11.2 Type test values of the conventional load voltage

11.2.1 Manual metal arc welding with covered electrodes

$$I_2 \text{ up to } 600 \text{ A: } U_2 = (20 + 0,04 I_2) \text{ V}$$

$$I_2 \text{ over } 600 \text{ A: } U_2 = 44 \text{ V}$$

11.2.2 Tungsten inert gas

$$I_2 \text{ up to } 600 \text{ A: } U_2 = (10 + 0,04 I_2) \text{ V}$$

$$I_2 \text{ over } 600 \text{ A: } U_2 = 34 \text{ V}$$

11.2.3 Metal inert/active gas and flux cored arc welding

$$I_2 \text{ up to } 600 \text{ A: } U_2 = (14 + 0,05 I_2) \text{ V}$$

$$I_2 \text{ over } 600 \text{ A: } U_2 = 44 \text{ V}$$

11.2.4 Submerged arc welding

$$I_2 \text{ up to } 600 \text{ A: } U_2 = (20 + 0,04 I_2) \text{ V}$$

$$I_2 \text{ over } 600 \text{ A: } U_2 = 44 \text{ V}$$

11.2.5 Plasma cutting

$$I_2 \text{ up to } 165 \text{ A: } U_2 = (80 + 0,4 I_2) \text{ V}$$

$$I_2 \text{ between } 165 \text{ A and } 500 \text{ A: } U_2 = (130 + 0,1 I_2) \text{ V}$$

$$I_2 \text{ above } 500 \text{ A: } U_2 = 180 \text{ V}$$

For plasma cutting using air, the manufacturer may specify the load voltage as determined under typical cutting conditions.

NOTE The manufacturer's load voltage is allowed due to the nature of the plasma process, i.e. the interaction of the plasma torch design, recommended plasma gas, cutting technique, etc. All influence the voltage at which satisfactory performance occurs.

11.2.6 Plasma welding

$$I_2 \text{ up to } 600 \text{ A: } U_2 = (25 + 0,04 I_2) \text{ V}$$

$$I_2 \text{ over } 600 \text{ A: } U_2 = 49 \text{ V}$$

11.2.7 Plasma gouging

$$I_2 \text{ up to } 300 \text{ A: } U_2 = (100 + 0,4 I_2) \text{ V}$$

$$I_2 \text{ over } 300 \text{ A: } U_2 = 220 \text{ V}$$

11.2.8 Additional requirements

Throughout its range of adjustment, the electrically powered welding power sources shall be capable of delivering conventional welding currents (I_2) at conventional load voltages (U_2) in accordance with 11.2.1 to 11.2.7.

Conformity shall be checked by sufficient measurements (see Annex H).

11.3 Mechanical switching devices used to adjust output

A switch, contactor, circuit-breaker or other control device used to adjust or control the level of output from the welding power source shall have an endurance suitable for the application.

Conformity shall be checked by the following test.

The device is installed in a test welding power source and subjected to 6 000 cycles of operation over the complete range of mechanical movement with the output at the no-load condition. If the device is in the supply circuit, the welding power source is operated at the highest rated supply voltage. Check that no electrical or mechanical failure of the device or damage to the welding power source occurs.

NOTE A component having demonstrated that it passes these tests can be used in other similar applications, if the other requirements are equal or less.

11.4 Welding circuit connections

11.4.1 Protection against unintentional contact

Welding circuit connections, with or without welding cables connected, shall be protected against unintentional contact by persons or by metal objects, for example vehicles, crane hooks, etc.

Examples of how such protection can be afforded:

- a) any live part of a coupling device is recessed behind the plane of the access opening. Devices complying with IEC 60974-12 meet the requirement;
- b) a hinged cover or a protective guard is provided.

Conformity shall be checked by visual inspection.

11.4.2 Location of coupling devices

Uncovered coupling devices shall be located so that their openings are not tilted upwards.

NOTE Coupling devices fitted with an automatic closing device can have their openings tilted upwards.

Conformity shall be checked by visual inspection.

11.4.3 Outlet openings

Where welding cables pass through metallic parts, the edges of the opening shall be smoothly rounded with a radius of at least 1,5 mm.

Conformity shall be checked by visual inspection.

11.4.4 Three-phase multi-operator welding transformer

All welding output connections intended to be connected to the workpiece shall have a common interconnection within the welding power source.

Welding output connections of the same phase shall all be marked in the same way as each other.

Conformity shall be checked by visual inspection.

11.4.5 Marking

Connections designed specifically for attachment to the workpiece or to the electrode shall be so identified.

For d.c. welding power sources, the polarity shall be clearly marked, either on the welding output connections or on the polarity selector. This requirement is not relevant for plasma cutting power sources.

Conformity shall be checked by visual inspection.

11.4.6 Connections for plasma cutting torches

The torch shall be connected to and disconnected from the plasma cutting power source:

- a) within the plasma cutting power source, by use of a tool, by screws or coupling devices;
or
- b) on the plasma cutting power source, by a coupling device which is:
 - 1) designed to avoid connection of incompatible torches
or
 - 2) operated by use of a tool.

When the coupling device is disconnected, no voltage higher than the limits of SELV accessible to the operator shall be present.

Conformity shall be checked by visual inspection and measurement.

11.5 Power supply to external devices connected to the welding circuit

When a welding power source supplies electrical power to an external device including a connection to the welding circuit, such power shall be supplied by one of the following:

- a) the welding circuit;
- b) a safety isolating transformer in accordance with IEC 61558-2-6 or equivalent means incorporated in the welding power source;
- c) an isolating transformer in accordance with IEC 61558-2-4 with a rated secondary voltage up to 120 V r.m.s. if all exposed conductive parts of the external device, as recommended by the manufacturer, are connected to the protective earth conductor that is protected against the welding current, for example by a current sensing relay or by insulation of the relevant metal parts, for example by an enclosure.

External devices include wire feed units, arc striking and stabilizing devices, torches, seam trackers or other devices containing a connection to the welding circuit.

Conformity shall be checked by visual inspection and fault simulation.

11.6 Auxiliary power supply

In the case of welding power sources designed to supply electrical power to external devices which are not a part of the welding circuit (for example for lighting, external cooling system or electric tools), these auxiliary circuits and accessories shall comply with the standards and regulations relating to the use of these external devices.

The welding circuit shall be isolated from such supply circuits in accordance with 6.2.4 and 6.3.2.

Near the socket-outlet of the auxiliary power supply, the available current, voltage, duty cycle if less than 100 %, a.c. or d.c. and the status of the neutral (for example earthed or unearthed) as appropriate, shall be clearly and indelibly marked.

Conformity shall be checked by visual inspection during the tests in accordance with 6.1.4, 6.1.5, 6.2.4 and 6.3.2 and by rubbing the marking in accordance with 15.1.

11.7 Welding cables

If a welding power source is supplied with welding cables, they shall meet the requirements of IEC 60245-6 or meet national and local regulations.

If a plasma cutting power source is supplied with welding cables, they shall meet the current and no-load voltage ratings suitable for the application and meet national and local regulations.

NOTE 1 Example or local regulations are given in Bibliography, e.g. IEC 60245-6 S2 or prEN 50525-2-81:2008. PVC insulation has been proved not suitable for the application and is not recognised in welding cable product standards of IEC or CENELEC.

NOTE 2 The rated voltage of welding cables complying with IEC 60245-6 is typically not suitable for plasma cutting applications.

12 Control circuits

12.1 General requirement

All inputs and outputs of control circuits shall be tested at the maximum load as specified by the manufacturer. Remote control circuits may be tested without connection to the power source, provided that the power source can be simulated.

12.2 Isolation of control circuits

A control circuit that leaves the enclosure and having a voltage lower than the allowable no-load voltage in accordance with 11.1.1 shall be:

- a) insulated from the supply circuit by double or reinforced insulation,
- b) insulated from all other circuits having a voltage higher than the allowable no-load voltage in accordance with 11.1.1 (e.g. auxiliary power supply circuits, plasma cutting circuit) by double or reinforced insulation and
- c) insulated from the welding circuit having a voltage lower than the allowable no-load voltage in accordance with 11.1.1 by basic insulation.

NOTE Example of insulation configuration for Class I equipment is given in 6.1.1.

Conformity shall be checked by measurement or analysis, as appropriate.

12.3 Working voltages of remote control circuits

The working voltages in remote control circuits that are designed to be handheld shall not exceed 50 V a.c. or 120 V ripple free d.c. between conductors, or between any conductor and protective circuit, under normal operating conditions and after a single fault.

NOTE Working voltage requirements for local or wide area computer networks are contained in IEC 60950-1.

Conformity shall be checked by measurement or analysis, as appropriate.

13 Hazard reducing device

13.1 General requirements

A hazard reducing device shall reduce the severity of the electric shock that can originate from no-load voltages exceeding the allowable rated no-load voltage for a given environment. Types of hazard reducing devices are given in 13.2.

Requirements are given in Table 14.

Table 14 – Hazard reducing device requirements

Unreduced no-load voltage in accordance with subclause	Reduced no-load voltage in accordance with subclause	Operating time s
Between 11.1.3 and 11.1.2	11.1.1	
Between 11.1.2 and 11.1.1	11.1.1	2
NOTE For d.c. welding power source above 113 V, an operating time of 0,3 s is required.		

13.2 Types of hazard reducing devices

13.2.1 Voltage reducing device.

A voltage reducing device shall have automatically reduced the rated no-load voltage to a level not exceeding the values of 11.1.1 at the moment the resistance of the external welding circuit exceeds 200 Ω. The operating time is specified in Table 14.

Such welding power sources may be marked with the symbol 84 of Annex L.

Conformity shall be checked by connecting a variable load resistor across the welding output connections of the welding power source. Voltage measurements and operating time are taken while the resistance is being increased.

13.2.2 Switching device for a.c. to d.c.

A switching device for a.c. to d.c. shall have automatically switched the rated a.c. no-load voltage to a rated d.c. no-load voltage not exceeding the values given in 11.1.1 at the moment the resistance of the external welding circuit exceeds 200 Ω. The operating time is specified in Table 14.

Such welding power sources may be marked with the symbol 84 of Annex L.

Conformity shall be checked in accordance with 13.2.1.

13.3 Requirements for hazard reducing devices

13.3.1 Disabling the hazard reducing device

The design shall be such that the operator cannot disable or by-pass the hazard reducing device without the use of a tool.

Conformity shall be checked by visual inspection.

13.3.2 Interference with operation of a hazard reducing device

Remote controls, as specified by the manufacturer, and arc striking or arc stabilizing devices of the welding power source shall not interfere with the proper functioning of the hazard reducing device, i.e. no-load voltage limits shall not be exceeded.

Conformity shall be checked by repeating the tests of 13.2.1 with any of the devices that could interfere with the operation of the hazard reducing device.

13.3.3 Indication of satisfactory operation

A reliable device, for example a signal lamp, shall be provided which indicates that the hazard reducing device is operating satisfactorily. Where a signal lamp is used, it shall light when the voltage has been reduced or changed to d.c.

Conformity shall be checked by visual inspection during the test in accordance with 13.1.

13.3.4 Fail to a safe condition

If the hazard reducing device fails to operate in accordance with 13.1, the voltage at the output terminals shall be reduced to a level not exceeding 11.1.1 in accordance with Table 14 and shall not be reset automatically.

Conformity shall be checked by simulating a fault of the hazard reducing device and measuring the time to reach a safe condition after failure of the hazard reducing device.

14 Mechanical provisions

14.1 General requirements

Equipment shall be constructed and assembled so that it has the strength and rigidity necessary to withstand the normal service to which it is likely to be subjected, without increasing the risk of electric shock or other hazards whilst maintaining the minimum clearances required. Equipment shall be provided with a case or cabinet that encloses all live and hazardous moving parts (such as pulleys, belts, fans, gears etc.) except that the following need not be fully enclosed:

- a) supply, control and welding cables;
- b) output terminals for the connection of welding cables.

After the tests in accordance with 14.2 to 14.5, the equipment shall comply with the provisions of this document. Some deformation of the structural parts or enclosure is permitted provided this does not reduce the level of safety protection.

Accessible parts shall have no sharp edges, rough surfaces or protruding parts likely to cause injury.

Conformity shall be checked by visual inspection after meeting the requirements of 14.2 to 14.5.

14.2 Enclosure

14.2.1 Enclosure materials

Non-metallic materials intended to protect from contact with live parts, except welding and SELV circuits, shall have a flammability classification of V-1 or better in accordance with IEC 60695-11-10.

Conformity is checked by inspection of non-metallic materials specification.

14.2.2 Enclosure strength

The enclosure, including air louvers, shall withstand an impact energy of 10 Nm in accordance with Annex I.

Handles, push buttons, adjustment dials etc. shall not be tested with the pendulum hammer.

Alternatively, the enclosure may be constructed of sheet metal with a minimum thickness in accordance with Annex J.

Conformity shall be checked in accordance with a) or b) below.

- a) By an impact test using a pendulum impact hammer in accordance with I.1 or using a free fall weight in accordance with I.2 or equivalent means as follows:
 - 1) one sample is tested;
 - 2) the welding power source is not energized during the test;
 - 3) select one impact point on each side, where the risk of electrical shock or malfunction is highest;
 - 4) apply three impacts to selected impact points.
- b) By measurement of the thickness of the sheet metal.

14.3 Handling means

14.3.1 Mechanised handling

If means for mechanical handling are provided (for example eyelet or lug) for the purpose of lifting an assembled equipment, these shall be capable of withstanding the mechanical stress of a static pull with a force calculated from the mass of the assembled equipment as follows.

- a) For equipment with a mass of up to 150 kg, a force calculated from 10 times the mass shall be used.
- b) For equipment with a mass of greater than 150 kg, a force calculated from four times the mass or at least 15 kN shall be used.

If only a single lifting means is provided, it shall be designed so that a torque applied during lifting cannot cause it to be loosened.

Conformity shall be checked by visual inspection and by the following test.

The equipment is fitted with all the associated attachments, (excluding gas cylinders, separate trailers, carts and wheel undercarriages) that are likely to be installed and, in the case of engine-driven welding power sources, completely serviced and ready for operation. The equipment is anchored rigidly at its base and a chain or cable is attached to its lifting means, as recommended by the manufacturer, and an upward force is then exerted continuously for 10 s.

If two or more lifting means are provided, the chains or cables are arranged so that the force is equally shared between them and is applied at an angle not greater than 15° to the vertical.

14.3.2 Manual handling

If means for manual handling are provided for lifting or carrying (for example handles, straps), these shall be capable of withstanding the mechanical stress of a static pull with a force calculated from the mass of the assembled equipment as follows.

A force calculated from four times the mass or at least 600 N shall be used.

Conformity shall be checked by visual inspection and by the following test.

The equipment is fitted with all the associated attachments, (excluding gas cylinders, separate trailers, carts and wheel undercarriages) that are likely to be installed. The equipment is anchored rigidly at its base and a chain or cable is attached to its handles or strap, as recommended by the manufacturer, and an upward force is then exerted continuously for 10 s.

14.4 Drop withstand

Equipment shall be capable of withstanding a drop test. For this test, the equipment shall be equipped with all the associated attachments, cooling liquid and filler wire (excluding gas cylinders, separate trailers, carts and wheel undercarriages, unless these items are standard equipment and permanently affixed) that are recommended to be installed.

The heights for the drop test shall be as follows:

- a) equipment with a mass of up to 25 kg shall withstand a drop of 250^{+10}_0 mm;
- b) equipment with a mass of greater than 25 kg shall withstand a drop of 100^{+10}_0 mm.

NOTE 1 Mass of equipment includes mass of associated attachments, cooling liquid and filler wire.

Conformity shall be checked by dropping the equipment three times on a hard and rigid surface. This test is so arranged that a different bottom edge of the equipment is struck each time it drops.

NOTE 2 In practice, one corner will touch the impact surface first.

Engine-driven welding power sources shall be filled up and be ready for immediate use.

14.5 Tilting stability

Equipment in its most unstable position shall not topple over when tilted up to 10°. Auxiliary items as specified by the manufacturer in accordance with the type of the equipment such as gas cylinders, wire feed unit or cooling device could affect the stability, and these shall be taken into account.

If the manufacturer specifies other auxiliary items, so that the requirement of this subclause cannot be met, then instructions shall be provided for anchorage or other means as necessary.

Conformity shall be checked by the following test.

The equipment is placed on a plane and tilted from the horizontal level.

15 Rating plate

15.1 General requirements

A clearly and indelibly marked rating plate shall be fixed securely to or printed on each welding power source.

NOTE The purpose of the rating plate is to indicate to the user the electrical characteristics, which enables the comparison and correct selection of welding power sources.

Conformity shall be checked by visual inspection and by rubbing the marking by hand for 15 s with a piece of cloth soaked with water and again for 15 s with a piece of cloth soaked with petroleum spirit.

After this test, the marking shall be easily legible. It shall not be easy to remove the rating plate and it shall show no curling.

15.2 Description

The rating plate shall be divided into sections containing information and data for the

- a) identification;
- b) welding output;
- c) energy supply.

The arrangement and sequence of the data shall comply with the principle shown in Figure 4 (for examples, see Annex K).

The dimensions of the rating plate are not specified and may be chosen freely.

It is permissible to separate the above sections from each other and affix them at locations more accessible or convenient for the user.

For welding power sources to be used for several welding processes or for rotating welding power sources, either one combined or several separate rating plate(s) may be used.

NOTE Additional information can be given. Further useful information, for example class of insulation, pollution degree or power factor, can be given in technical literature supplied by the manufacturer (see 17.1).

a) Identification					
1)					
2)			3)		
4) Optional			5)		
b) Welding output					
6)		8)		10)	
		11)		11a)	11b)
7)		9)		12)	12a)
		13)		13a)	13b)
				12b)	12c)
				13b)	13c)
c) Energy supply					
14)		15) or 18)		16)	17)
		or 19)		or 20) If applicable	or 21) If applicable
22) Optional		23) If applicable			

IEC 476/98

Figure 5 – Principle of the rating plate

15.3 Contents

The following explanations refer to the numbered boxes shown in Figure 5.

a) Identification

Box 1 Name and address of the manufacturer or distributor or importer and, optionally, a trade mark and the country of origin, if required.

Box 2 Type (identification) as given by the manufacturer.

Box 3 Traceability of design and manufacturing data, for example serial number.

Box 4 Welding power source symbol (optional) for example:



Single-phase transformer

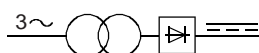

Three-phase transformer-rectifier

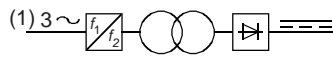

Single- or three-phase static frequency converter-transformer-rectifier

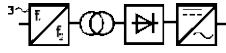

Inverter power source with a.c. and d.c. output

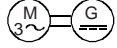

Three-phase motor-generator



Three-phase motor-generator-rectifier

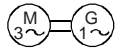

Three-phase rotating frequency converter

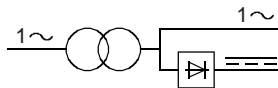

Single-phase combined a.c. and d.c. power source



Engine-a.c. generator

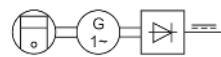

Engine-generator-rectifier

Box 5 Reference to the standards confirming that the welding power source complies with their requirements.

b) Welding output

Box 6 Welding process symbol for example:



Manual metal arc welding with covered electrodes



Tungsten inert-gas welding



Metal inert and active gas welding including the use of flux cored wire



Self shielded flux cored arc welding



Submerged arc welding



Plasma cutting



Plasma gouging



Plasma welding

Box 7



Symbol for welding power sources which are suitable for supplying power to welding operations carried out in an environment with increased risk of electric shock (if applicable).

NOTE 1 In addition, this symbol, of a suitable size, can be displayed on the front of the welding power source.

Box 8 Welding current symbol for example:



Direct current



Alternating current, and additionally the rated frequency in hertz for example: ~50 Hz



Direct and alternating current at the same output, and additionally the rated frequency in hertz

Box 9 U_0 ... V Rated no-load voltage

- a) peak value in case of direct current;
- b) r.m.s. value in case of alternating current.

NOTE 2 If a welding power source is fitted with a hazard reducing device, this is the voltage measured before the hazard reducing device has performed its function.

If several no-load voltages are adjustable, their range shall be given by the rated minimum and maximum no-load voltage.

Additionally, the following shall be given.

- a) U_r ... V reduced rated no-load voltage in case of a voltage reducing device;
- b) U_s ... V switched rated no-load voltage in case of an a.c. to d.c. switching device.

Box 10 ... A/... V to... A/... V Range of output, minimum welding current and its corresponding conventional load voltage or less, maximum welding current and its corresponding conventional load voltage or greater.

Box 11 X Duty cycle symbol.

Box 12 I_2 Rated welding current symbol.

Box 13 U_2 Conventional load voltage symbol.

Boxes 11a, 11b, 11c ... % Values of the duty cycle at an ambient temperature of 40 °C.

12a, 12b, 12c ... A Values of the rated welding current.

13a, 13b, 13c ... V Values of the conventional load voltage.

These boxes form a table with corresponding values of the three settings:

- a) ... % duty cycle at the rated maximum welding current;
- b) 60 % duty cycle;
and
- c) 100 % duty cycle as far as relevant.

Column a) need not be used if the duty cycle for the rated maximum welding current is 60 % or 100 %.

Column b) need not be used if the duty cycle at the rated maximum welding current is 100 %.

c) Energy supply

Box 14 Energy supply symbol, for example:

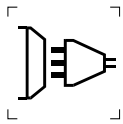

Supply circuit, number of phases (for example 1 or 3), symbol for alternating current and the rated frequency (for example 50 Hz or 60 Hz)



Engine



Motor

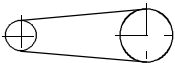

Belt drive

<http://www.china-gauges.com/>

Box	Electrically powered welding power sources		Box	Mechanically powered welding power sources	
15	$U_{1...}$ V	Rated supply voltage	18	$n... \text{ min}^{-1}$	Rated load speed
16	$I_{1\text{max}...}$ A	Rated maximum supply current	19	$n_0... \text{ min}^{-1}$	Rated no-load speed
17	$I_{1\text{eff}...}$ A	Maximum effective supply current	20	$n_i... \text{ min}^{-1}$	Rated idle speed, if applicable
Boxes 15 to 17 form a table with corresponding values.			21	$P_{1\text{max}...}$ kW	Maximum power consumption, if applicable

Box 22 IP.. Degree of protection, for example IP21 or IP23.

Box 23  Symbol for class II equipment, if applicable.

Conformity shall be checked by visual inspection and by checking of complete data.

15.4 Tolerances

Manufacturers shall meet rating plate values within the following tolerances by controlling component and manufacturing tolerances:

- U_0 rated no-load voltage in V $\pm 5\%$ measured in accordance with 11.1, but in no case shall the values summarized in Table 13 be exceeded;
- $I_{2\text{min}}$ rated minimum welding current in A;
 $U_{2\text{min}}$ minimum conventional load voltage in V;
The values of b) shall not be greater than those stated on the rating plate.
- $I_{2\text{max}}$ rated maximum welding current in A;
 $U_{2\text{max}}$ maximum conventional load voltage in V;
The values of c) shall not be less than those stated on the rating plate.
- n_0 rated no-load speed of rotation in $\text{min}^{-1} \pm 5\%$;
- $P_{1\text{max}}$ maximum power consumption in kW $\begin{matrix} +10 \\ 0 \end{matrix} \%$;
- $I_{1\text{max}}$ rated maximum supply current in A $\pm 10\%$.

Conformity shall be checked by measuring under conventional welding conditions (see 3.17).

15.5 Direction of rotation

If necessary, the direction of rotation shall be indicated on rotating welding power sources.

Conformity shall be checked by visual inspection.

16 Adjustment of the output

16.1 Type of adjustment

If the welding power source has a means to adjust the output current, output voltage or both, the adjustment may be continuous, step-by-step or both.

In the case of a continuous adjustment with several ranges, there shall be no gap between the ranges.

Conformity shall be checked by measuring.

16.2 Marking of the adjusting device

The output of the welding power source corresponding to different control settings shall be clearly and indelibly marked either on or by the controls, or displayed digitally.

With the exception of welding power sources that are set or adjusted with or by means of a digital read-out, the following shall apply.

- a) The setting indications on the scales or control tables shall take into account the relationship between the conventional load voltage and the conventional welding current.
- b) Each position in the case of a step-by-step adjustment or each major graduation in the case of a continuous adjustment shall be clearly marked with
 - 1) a numerical indication of the controllable parameters;
or, where this is not possible,
 - 2) an alphanumeric marking.In case 2), a table on the apparatus or in the instructions shall indicate, for each control position, the nominal value of the (control) parameter.
- c) In the case of multiple range adjustment, maximum and minimum values for each range shall be given.
- d) Welding power sources designed for use with more than one process, for which the conventional load voltage differs, shall be marked with a separate control scale for each process. If this is not possible, alphanumeric marks as given in b) shall be used.
- e) Where the welding power source is designed so that it can be supplied at several rated supply voltages and where, for the same control position, the numerical values of the welding parameters are not the same, separate scales or a separate series of alphanumeric markings shall be fitted.

Conformity shall be checked by visual inspection.

16.3 Indication of current or voltage control

Where there is a voltage or current control, the output setting shall be indicated in volts, amperes or an arbitrary reference scale.

The accuracy of voltage or current indication shall be

- a) between 100 % and 25 % of the maximum setting ± 10 % of the true value;

- b) below 25 % of the maximum setting $\pm 2,5$ % of the maximum setting.

If the manufacturer provides an ammeter or a voltmeter on the equipment, this shall be of class 2,5 and be properly damped.

Conformity shall be checked by measurement and visual inspection.

17 Instructions and markings

17.1 Instructions

Each welding power source shall be delivered with instructions which shall include the following (as applicable):

- a) general description;
- b) mass of the welding power source and its various parts and correct methods of handling them, for example by fork-lift or crane, and precautions to be taken with gas cylinders, wire feeders, etc.;
- c) the meaning of indications, markings and graphical symbols;
- d) information for selection and connection to the supply network (for example suitable supply cables, connection devices or attachment plugs, including the type and rated values for RCD, fuse or circuit-breaker, see also caution of 6.1.1) by qualified personnel in accordance with relevant national and local regulations;

NOTE Some national and local regulations require use of RCDs. Types of RCDs and their use are given in Annex B of IEC/TR 60755:2008. Only Type B" RCDs provide protection where supply circuit d.c. fault currents are likely to occur.

- e) correct operational use relating to the welding power sources (for example cooling requirements, location, control device, indicators, fuel type);
- f) welding capability, static characteristic (drooping and/or flat), duty cycle (duty factor) limitations and explanation of thermal protection if relevant;
- g) limitations of use relating to the degree of protection provided, for example welding power sources are not suitable for use in rain or snow;
- h) basic guidelines regarding protection against personal hazards for operators and persons in the work area (for example electric shock, fumes, gases, arc rays, hot metal, sparks, noise, back injury during manual handling);
- i) conditions under which extra precautions are to be observed when welding or cutting (for example environment with increased risk of electric shock, flammable surroundings, flammable products, closed containers, elevated working positions, etc.);
- j) how to maintain the welding power source, such as recommended cycles for partial and complete test and other operation (for example cleaning);
- k) a list of parts typically replaced due to wear;
- l) information on supply of electrical power to external devices, for example for lighting or electric tools;
- m) precautions against toppling over, if the welding power source shall be placed on tilted plane;
- n) warning against the use of a welding power source for pipe thawing;
- o) type (identification) of plasma cutting torches that are specified for use with the plasma cutting power source;
- p) pressure, flow rate and type of plasma gas and if relevant, of cooling gas or cooling liquid;
- q) steps or range of the output current and the corresponding plasma gas as a set of values;
- r) EMC classification in accordance with IEC 60974-10;

- s) for an engine-driven power source, warning against the carbon monoxide component of engine exhaust (example of National Labelling Regulation is given in *US Code of Federal Regulations, Title 16, Parts 1407*).

Other useful information may also be given, for example class of insulation, pollution degree, efficiency (see Annex M), etc.

Conformity shall be checked by reading the instructions.

17.2 Markings

Each welding power source shall be clearly and indelibly marked on or near the front panel or near the ON/OFF switching device with the following combination of symbols to signify "Caution! Read instruction manual":



This marking shall also be used near the torch connector of plasma cutting power sources indicating that the operator should read the instruction manual before selecting and connecting a torch.

The following equivalent wording may be used:

Warning: Read instruction manuals before operating and servicing this equipment.

For other additional markings, see Annex L.

NOTE Precautionary labels appearing on power sources can consist of text only, text and symbols, or symbols only. Symbols-only precautionary labels are specified in ISO 17846.

Conformity shall be checked by visual inspection and by testing in accordance with the durability test in 15.1.

Annex A
(informative)

Nominal voltages of supply networks

Voltage line-to-neutral derived from nominal voltages a.c. or d.c. up to and including	Nominal voltages presently used in the world			
	Three-phase four-wire systems with earthed neutral	Three-phase three-wire systems earthed or unearthened (E)	Single-phase two-wire systems a.c. or d.c.	Single-phase three-wire systems a.c. or d.c.
V				
50			12,5 24 25 30 42 48	30-60
100	66/115	66	60	
150	120/208*, 127/220	115, 120, 127	100**, 110, 120	100-200**, 110-220, 120-240
300	220/380, 230/400, 240/415, 260/440, 277/480	200**, 220, 230, 240, 260, 277	220	220-440
600	347/600, 380/660, 400/690, 417/720, 480/830	347, 380, 400, 415, 440, 480 500, 577, 600	480	480-960
1 000		660, 690, 720, 830, 1 000	1 000	

NOTE 1 Values taken from Table B.2 of IEC 60664-1:2007.

NOTE 2 "E" means "earthed".

* Common practice of the United States of America and Canada.

** Common practice of Japan.

Annex B
(informative)

Example of a combined dielectric test

Two high voltage transformers may be connected in series, correctly phased.

The common connection is to exposed conductive parts (See Figure B.1).

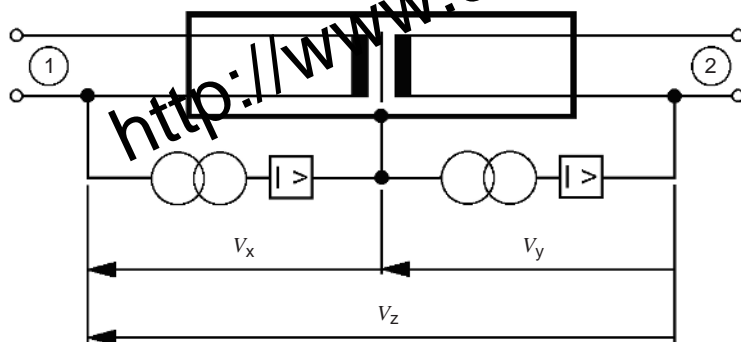

IEC 914/12

Key



Current sensing tripping device



Supply circuit



Welding circuit

V_x Supply circuit to exposed conductive parts

V_y Welding circuit to exposed conductive parts

V_z Supply circuit to welding circuit

Figure B.1 – Combined high-voltage transformers

Annex C (normative)

Unbalanced load in case of a.c. tungsten inert-gas welding power sources

C.1 General

The difference in emissivity between the electrode and the workpiece in a.c. tungsten inert-gas welding causes an unbalanced welding voltage and a corresponding unbalance in the welding current.

This unbalance is called the d.c. component, and can cause saturation of the transformer of a transformer type welding power source. Such saturation will cause an abnormally high supply current that could cause severe over-heating.

Figure C.1 shows that the welding current has a d.c. component \bar{I}_2 that may overheat the winding of the welding power source.

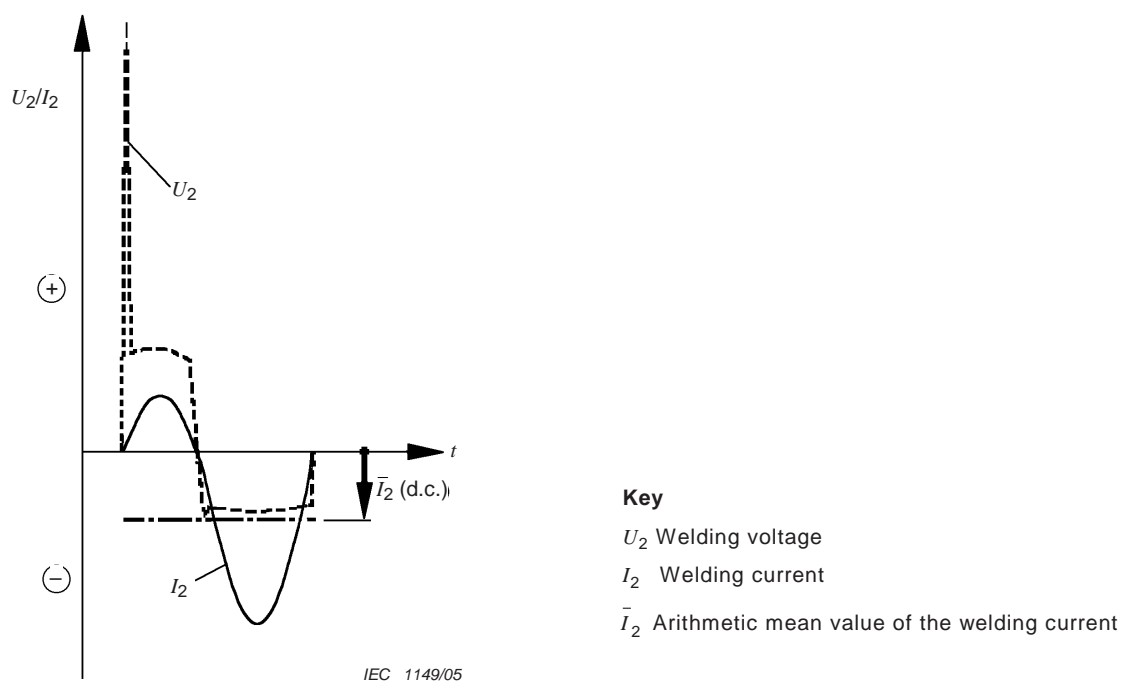
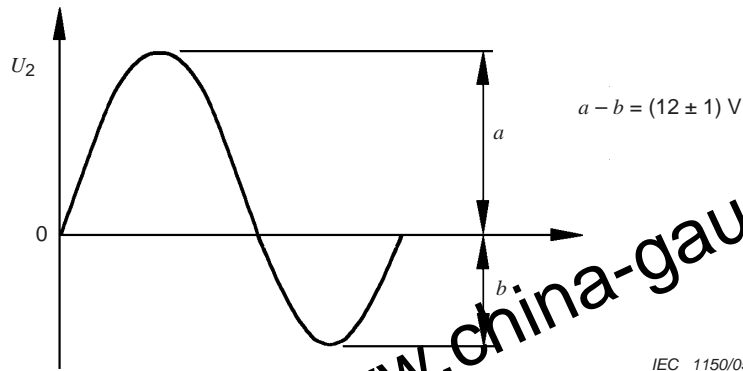

Figure C.1 – Voltage and current during a.c. tungsten inert-gas welding

C.2 Unbalanced load

To simulate the required welding currents for the heating test, a conventional load shall be used with a partial rectifying characteristic, so that if the polarity of the electrode is negative, the half-cycle voltage shall be (12 ± 1) V less than the half-cycle voltage if the polarity of the electrode is positive (see Figure C.2).



Key

- a* peak voltage value when electrode is positive
- b* peak voltage value when electrode is negative

Figure C.2 – Unbalanced voltage during a.c. tungsten inert-gas welding

This difference of the half-cycle welding voltages is determined by passing a d.c. test current through the unbalanced load in both directions and measuring the d.c. load voltage.

Welding power sources that incorporate a balance control are tested with a conventional load, but with the balance control set to the condition producing the maximum unbalance, but not higher than 12 V.

C.3 Example for an unbalanced load

The rectifying characteristic of the load is achieved by a circuit of diodes in accordance with Figure C.3.

The required voltage difference between the half-cycle voltages is adjusted by the numbers of diodes in the string.

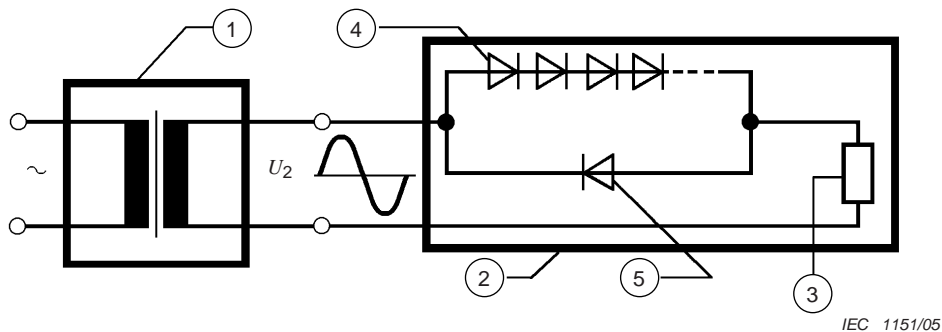

Key

- | | | |
|-------------------|---------------------|----------------|
| 1 Transformer | 3 Conventional load | 5 Single diode |
| 2 Unbalanced load | 4 Series of diodes | |

Figure C.3 – AC welding power source with unbalanced load

Annex D (informative)

Extrapolation of temperature to time of shutdown

When the temperature at the instant of shutdown cannot be recorded, it is necessary to use an extrapolation to obtain this temperature. The procedure for such extrapolation is as follows:

- a) the time is marked at the instant of shutdown;
- b) successive temperature readings are taken, and the elapsed time from shutdown noted for each;
- c) a minimum of four readings is taken for each temperature to be extrapolated;
- d) using logarithmic/linear graph paper, the readings are plotted so that the temperature is against the logarithmic scale, and the time from shutdown against the linear scale. A straight line extending back to $t = 0$ will give the extrapolated temperature at shutdown.

Alternative: A mathematical regression analysis can be used as an alternative to the graphical method. If a linear regression is chosen, then the logarithms of the temperatures are used with the linear values of the reading times from the instant of shutdown. The regression analysis is solved for the time $t = 0$ and the antilogarithm taken to find the true temperature.

Annex E (normative)

Construction of supply circuit terminals

E.1 Size of terminals

The terminals shall be dimensioned in accordance with the maximum effective supply current $I_{1\text{eff}}$ and it shall be possible to connect flexible conductors with cross-sectional areas as given in Table E.1. These values are based on wire size at 60 °C.

Table E.1 – Range of conductor dimensions to be accepted by the supply circuit terminals

Maximum effective supply current A	Range of cross-sectional area of the conductor mm ²
10	1,5 to 2,5
16	1,5 to 4
25	2,5 to 6
35	4 to 10
50	6 to 16
63	10 to 25
80	16 to 35
100	25 to 50
125	35 to 70
160	50 to 95
200	70 to 120
250	95 to 150
315	120 to 240
400	150 to 300

Alternative cross-section ranges are permitted if the manufacturer indicates in the instructions the type and size of wire to be used.

Conformity shall be checked by calculation and measurement.

E.2 Connections at the terminals

Connections at the terminals shall be made by means of screws, nuts or other equivalent means and shall comply with the requirement given in 5.3.

NOTE Electrical quick-connect terminals are considered equivalent when fitted with two independent fixings, one clamping the insulation and the other clamping the conductor.

The terminal screws or nuts shall not be used to secure other parts or to connect other conductors.

Conformity shall be checked by visual inspection.

E.3 Construction of the terminals

Conductors or their lugs shall be clamped between metallic parts and shall not be able to escape when the clamping means are tightened.

Live parts that can turn and reduce the clearance shall not rely on friction between mounting surfaces to prevent turning. A suitable lock washer, properly applied, shall be acceptable. Leads or busbars that are secured by other means need not have a lock washer.

Iron or steel, plain or plated, shall not be used for current carrying parts.

Conformity shall be checked by visual inspection and by the temporary connection of conductors with the minimum and maximum cross-sectional area specified.

E.4 Fixing of the terminals

The terminals shall be securely fixed so that they cannot work loose when the clamping means are tightened or loosened. Furthermore, if friction alone is relied on to prevent turning or shifting of the terminals on the supporting surface, the clearances shall not be reduced below the values of Table 1 by shifting or turning. A pressure terminal connector need not be prevented from turning provided no clearances less than those required result when the terminals are turned 30° towards each other, or towards other uninsulated parts of opposite polarity, or towards grounded metal parts.

Conformity shall be checked by visual inspection and by tightening and loosening 10 times the clamping means holding a conductor of the maximum cross-sectional area specified.

The test shall be repeated using a conductor of the minimum cross-sectional area specified.

Annex F
(informative)

Cross-reference to non-SI units

Cross references to non-SI units for short-circuit test (see 9.3) are given in Table F.1

Table F.1 – Cross-reference for mm² to American wire gauge (AWG)

mm ²	AWG
1,5	15
2,5	13
4	11
6	9
10	7
16	5
25	3
35	1
50	1/0
70	2/0
95	3/0
120	250 MCM
150	350 MCM
240	600 MCM
300	700 MCM

<http://www.china-gauges.com/>

Annex G
(informative)

**Suitability of supply network for the measurement
of the true r.m.s. value of the supply current**

The peak and r.m.s. values of the supply current (I_1) can be substantially affected by the supply network impedance (R_s). To obtain valid measurements, the supply network impedance is 4 % or less than the input impedance of the welding power source:

$$R_s \leq 0,04 \frac{U_1}{I_1} (\Omega) \quad (G.1)$$

where

R_s is the impedance of the supply network in ohms;

U_1 is the rated supply voltage in volts;

I_1 is the rated supply current in amperes.

To determine the impedance of the supply network, it is loaded by a conventional load that is able to reduce the supply voltage at least 1 % below the unloaded value.

NOTE 1 If the rated voltage of this conventional load is lower than the supply voltage, a transformer can be used.

NOTE 2 Automatic supply network voltage regulators are turned off.

NOTE 3 If a transformer is used $I_{1 \text{ unloaded}}$ is the no-load current of that transformer, otherwise $I_{1 \text{ unloaded}} = 0$ A.

The impedance of the supply network is calculated by the following formula:

$$R_s = \frac{U_{1 \text{ unloaded}} - U_{1 \text{ loaded}}}{I_{1 \text{ loaded}} - I_{1 \text{ unloaded}}} (\Omega) \quad (G.2)$$

where

R_s is the impedance of the supply network in ohms;

$U_{1 \text{ loaded}}$ is the supply voltage in volts when loaded by a conventional load;

$U_{1 \text{ unloaded}}$ is the supply voltage in volts when unloaded;

$I_{1 \text{ loaded}}$ is the supply current in amperes when loaded by a conventional load;

$I_{1 \text{ unloaded}}$ is the supply current in amperes when unloaded.

Example:

Supply network:	$U_{1 \text{ unloaded}}$	= 230 V	$I_{1 \text{ unloaded}}$	= 1 A
	$U_{1 \text{ loaded}}$	= 227 V	$I_{1 \text{ loaded}}$	= 31 A

$$R_s = \frac{230 - 227}{31 - 1} = 0,10 \Omega$$

Welding power source: $U_1 = 230$ V $I_{1 \text{ max}} = 30$ A

With these values, the condition in accordance with equation (G.1) is fulfilled:

$$R_s = 0,10 \Omega \leq 0,04 \frac{230}{30} = 0,31 \Omega$$

Annex H (informative)

Plotting of static characteristics

H.1 General

By varying the resistance of a conventional load connected to the output terminals of the welding power source, a set of values of welding current (I_2) and corresponding load voltage (U_2) may be obtained for a given output setting of the welding power source. The static characteristic is obtained by plotting these values on a graph with the welding current on the horizontal and the load voltage on the vertical axis.

The slope of the static characteristic is given by its tangent at the operating point.

H.2 Method

The number of values measured should be sufficient to enable a smooth curve to be plotted. In all cases, the no-load voltage and the rated values corresponding to each duty cycle (duty factor) stated on the rating plate should be recorded. For drooping characteristic welding power sources, the short-circuit current should also be recorded.

If the welding power source has a step-by-step setting, values should be measured at each position of the control. If a welding power source is designed for several supply voltages, the measurement should be repeated at each supply voltage.

For each point, the following should also be recorded: supply voltage (U_1), supply current (I_1), power delivered to the welding power source (P_1).

For welding power sources with no feedback circuitry (for example simple transformers), the values of U_2 and I_2 should be multiplied by a correction factor of (U_1/U_1') if the measured supply voltage (U_1') differs from the rated supply voltage (U_1). The power (P_1) should be multiplied by $(U_1/U_1')^2$.

H.3 Analysis of the results

The series of curves obtained for the static characteristics of a welding power source may be used to confirm conformity to the relevant requirements of this document. If the negative slope at the operating point is greater than or equal to 7 V per 100 A, the static characteristic is considered to be drooping.

Annex I
(normative)

Test methods for a 10 Nm impact

I.1 Pendulum impact hammer

The welding power source is placed against a rigid vertical surface and the impact is directed against the opposite side.

The angle of rotation θ (see Figure I.1) is adjusted (see Table I.1) to account for hammer and swing arm tolerances with the objective of delivering the required impact energy of 10 Nm.

Table I.1 Angle of rotation θ to obtain 10 Nm impact

Hammer mass kg	1	1,5	2	2,5	3
Angle of rotation θ degree	90	71	60	53	48

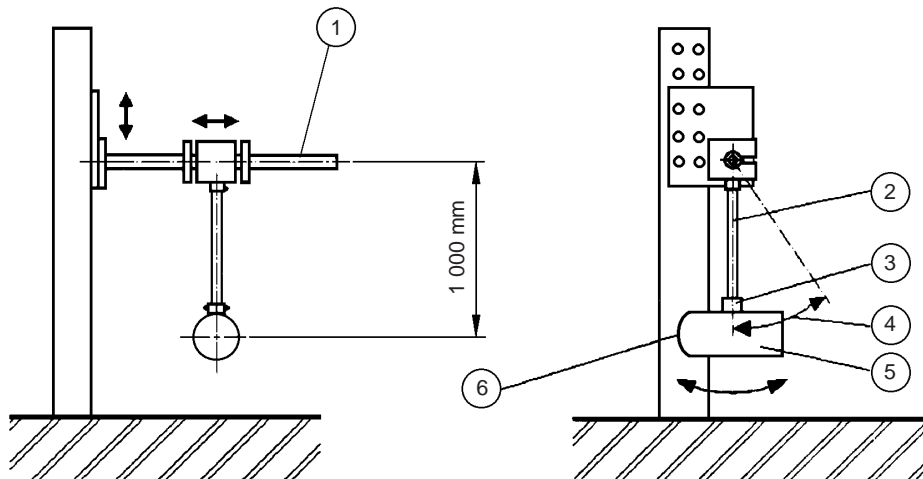

IEC 1152/05

Key

- 1 Support shaft (should not deflect more than 1,5 mm)
- 2 Swing arm, steel tubing (its mass is negligible)
- 3 Hammer collar (mass up to 100 g)
- 4 Angle of rotation θ
- 5 Steel hammer
- 6 Radius 50 ± 2 mm

Figure I.1 – Test set-up

I.2 Free fall spherical steel weight

The welding power source is laid on a rigid horizontal surface. The mass of the free fall weight and the height of the free fall are given in Table I.2.

Table I.2 – Mass of the free fall weight and height of the free fall

Mass kg	0,50	0,75	1,00	1,25	1,50	1,75	2,00
Height m	2,04	1,36	1,02	0,82	0,68	0,58	0,51

Annex J
(normative)

Thickness of sheet metal for enclosures

The minimum thickness of sheet metal for enclosures shall be

- a) for steel, in accordance with Table J.1;
- b) for aluminium, brass or copper, in accordance with Table J.2

The thickness values are based on a uniform deflection of the indicated sheet metal sizes, if loaded at the centre of their surface.

The thickness of an enclosure may be less than that given in Tables J.1 and J.2, if the enclosure shows the same deflection as an enclosure of the same size having the required thickness.

Table J.1 – Minimum thickness of sheet metal for steel enclosures

Minimum thickness of uncoated steel ^a mm	Without supporting frame ^b		With supporting frame ^c	
	Maximum width mm	Maximum length mm	Maximum width mm	Maximum length mm
0,50	105 125	Not limited 150	160 175	Not limited 210
0,65	155 180	Not limited 225	245 255	Not limited 320
0,80	205 230	Not limited 300	305 330	Not limited 410
1,00	320 360	Not limited 460	500 535	Not limited 635
1,35	460 510	Not limited 635	690 740	Not limited 915
1,50	560 635	Not limited 790	840 890	Not limited 1 095
1,70	635 740	Not limited 915	995 1 045	Not limited 1 295
2,00	840 890	Not limited 1 200	1 295 1 375	Not limited 1 680
2,35	1 070 1 200	Not limited 1 500	1 630 1 730	Not limited 2 135
2,70	1 325 1 525	Not limited 1 880	2 035 2 135	Not limited 2 620
3,00	1 600 1 860	Not limited 2 290	2 470 2 620	Not limited 3 230

- ^a 1) For stainless steel, only 80 % of the given values are necessary.
2) For zinc-coated steel, the thickness shall be adjusted to take into account the coating thickness (usually 0,05 mm to 0,1 mm).
- ^b Constructions considered to be without a supporting frame are for example:
1) a single sheet with single formed flanges;
2) a single sheet that is corrugated or ribbed;
3) an enclosure surface loosely attached to a frame, for example with spring clips or latch;
4) an enclosure surface having an unsupported edge.
- ^c These two columns apply when the enclosure is strengthened by one of the following means:
1) a supporting frame that is a structural channel, angle, or folded rigid section that is at least equal to the metal thickness of the enclosure, and is rigidly attached to the enclosure;
2) a supporting frame other than metal that has an equivalent torsional rigidity to a sheet steel angle in accordance with 1) above, and is fire resistant;
3) all of the edges of the enclosure are turned through a 90° angle to produce a formed flange with a minimum width of 10 mm.

Table J.2 – Minimum thickness of sheet metal for enclosures of aluminium, brass or copper

Minimum thickness of metal mm	Without supporting frame ^a		With supporting frame ^b	
	Maximum width mm	Maximum length mm	Maximum width mm	Maximum length mm
0,55	80	Not limited 110	180	Not limited 245
	90		220	
0,70	105	Not limited 155	260	Not limited 345
	130		270	
0,90	155	Not limited 205	360	Not limited 460
	165		385	
1,10	205	Not limited	485	Not limited 640
	245		535	
1,45	305	Not limited 410	715	Not limited 940
	360		765	
1,90	460	Not limited 635	1 070	Not limited 1 400
	510		1 145	
2,40	635	Not limited 915	1 525	Not limited 1 985
	740		1 630	
3,10	940	Not limited 1 350	2 210	Not limited 2 900
	1 070		2 365	
3,85	1 325	Not limited 1 880	3 125	Not limited 4 065
	1 525		3 305	

^a Constructions considered to be without a supporting frame are for example:

- 1) a single sheet with single formed flanges;
- 2) a single sheet that is corrugated or ribbed;
- 3) an enclosure surface loosely attached to a frame, for example with spring clips or latch;
- 4) an enclosure surface having an unsupported edge.

^b These two columns apply when the enclosure is strengthened by one of the following means:

- 1) a supporting frame that is a structural channel, angle, or folded rigid section that is at least equal to the metal thickness of the enclosure, and is rigidly attached to the enclosure;
- 2) a supporting frame other than metal that has an equivalent torsional rigidity to a sheet steel angle in accordance with a) above, and is fire resistant;
- 3) all of the edges of the enclosure are turned through a 90° angle to produce a formed flange with a minimum width of 10 mm.

Annex K
(informative)

Examples of rating plates

Examples of rating plates are given in Figures K.1 to K.5





a) Identification					
1) Manufacturer Address		2) Type			
3) Trademark		3) Serial number		5) IEC 60974-1 IEC 60974-10 Class A	
4) 					
b) Welding output					
6) 		8) ~50 Hz	10) 15 A / 20,6 V to 160 A / 27 V		
		11) X	11a) 35 %	11b) 60 %	11c) 100 %
7) 		9) $U_0 = 48 \text{ V}$	12) I_2	12a) 160 A	12b) 130 A
		13) U_2	13a) 26 V	13b) 25 V	13c) 24 V
c) Energy supply					
14)  1 ~ 50 Hz		15) $U_1 = 230 \text{ V}$	16) $I_{1\text{max}} = 37 \text{ A}$	17) $I_{1\text{eff}} = 22 \text{ A}$	
22) IP23		23) 			

Figure K.1 – Single-phase transformer



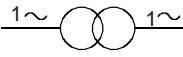



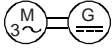

a) Identification					
1) Manufacturer		Trademark			
Address					
2) Type			3) Serial number		
4) 		5) IEC 60974-1 IEC 60974-100 Class A			
b) Welding output					
6) 		8) ~450 Hz	10) 60 A / 22 V to 500 A / 40 V		
		11) $\frac{U_1}{U_2}$	11a) 35 %	11b) 60 %	11c) 100 %
7)		9) $U_0 = 78 \text{ V}$	12a) 500 A	12b) 400 A	12c) 320 A
		13) U_2	13a) 40 V	13b) 36 V	13c) 33 V
c) Energy supply					
14) 		18) $n = 2\,800 \text{ min}^{-1}$			
3 ~ 50 Hz		15) $U_1 = 400 \text{ V}$	16) $I_{1\text{max}} = 68 \text{ A}$	17) $I_{1\text{eff}} = 40 \text{ A}$	
22) IP23		23)			

Figure K.2 – Three-phase rotating frequency converter

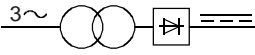
Distributor-related plate

a) Identification	
1) Manufacturer Address	Trademark
2) Type	3) Serial number

Manufacturer-related plate

a) Identification	
4) 	5) IEC 60974-1 IEC 60974-10 Class A
b) Welding output	
6) 	8) 
10) 20 A / 20,8 V to 250 A / 30 V	
11) X	11a) 35 % 11b) 60 % 11c) 100 %
7) 	9) $U_0 = 105 \text{ V}$
12) I_2	12a) 250 A 12b) 200 A 12c) 160 A
13) U_2	13a) 30 V 13b) 28 V 13c) 27 V
c) Energy supply	
14)  1(3) ~ 50 Hz	15) $U_1 = 230 \text{ V}$ $U_1 = 400 \text{ V}$
	16) $I_{1\text{max}} = 57 \text{ A}$ $I_{1\text{max}} = 34 \text{ A}$
	17) $I_{1\text{eff}} = 34 \text{ A}$ $I_{1\text{eff}} = 20 \text{ A}$
22) IP23	23) 

IEC 915/12

Figure K.3 – Subdivided rating plate: single-/three-phase transformer rectifier





a) Identification				
1)	Manufacturer Address	Trademark		
2)	Type	3)	Serial number	
4)		5)	IEC 60974-1	
b) Welding output				
6)		8)		
		10)	40 A / 110 V to 400 A / 36 V	
		11)	11a) 35 %	11b) 60 %
			11c) 100 %	
7)		9) $U_0 = 110 \text{ V}$	12a) 400 A	12b) 320 A
		12c) 255 A		
		13) U_2	13a) 36 V	13b) 33 V
			13c) 30 V	
c) Energy supply				
14)	 3 ~ 50 Hz	18)	$n = 3\ 150 \text{ min}^{-1}$	
		19) $n_0 = 3\ 300 \text{ min}^{-1}$	20) $n_i = 980 \text{ min}^{-1}$	21) $P_{1\text{max}} = 34 \text{ kW}$
22)	IP23	23)		

Figure K.4 – Engine-generator-rectifier



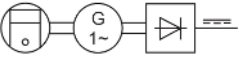



a) Identification					
1) Manufacturer Address		Trademark			
2) Type			3) Serial number		
4) 			5) IEC 60974-1 IEC 60974-100 Class A		
b) Welding output					
6) 		8) 		10) 250 A / 20,8 V to 250 A / 32 V	
		11) I_2		11a) 35 %	11b) 60 %
		12) I_2		12a) 250 A	12b) 200 A
		13) U_2		13a) 30 V	13b) 28 V
7) 		9) $U_0 = U_{open}$		12c) 160 A	13c) 27 V
c) Energy supply					
14)  1 (3) ~ 50 Hz		15) U_1 230 V 400 V		16) I_{1max} 57 A 34 A	
				17) I_{1eff} 34 A 20 A	
22) IP23S		23) 			

Figure K.5 – Single-/three-phase inverter type

Annex L (informative)

Graphical symbols for arc welding equipment

L.1 General

This Annex describes symbols, which are not all internationally standardized, but of practical use in welding applications. IEC technical committee 26 and subcommittee 3C have decided to consider those symbols for a future possible inclusion in IEC 60417. When this process will be terminated, this Annex will be modified accordingly.

This annex contains graphic symbols for arc welding and allied processes equipment to identify controls, indicators, connection points, functions, and to select processes.

The symbols are for use on the panel, the rating plate and any documentation for arc welding and allied processes equipment.

This annex does not cover graphic symbols used to alert personnel of immediate or potential personal hazards in the use of the equipment.

NOTE 1 For safety symbols, see ISO 3864-1.

NOTE 2 For installation instructions, see IEC 60974-9 and IEC 62079.

L.2 Use of symbols

L.2.1 General

Symbols should be placed on equipment to instruct on use and operation. Examples of control panel are given in L.5.

L.2.2 Selection of symbols

Symbols specified in Clause L.3 can be used either as a single item or in combination to fit the intended application. Examples of combinations are given in L.4.

L.2.3 Size of symbols

For the application of these symbols, it may be necessary either to reduce or to enlarge the original to a suitable size. In the case of symbols composed of several graphic elements, or when reducing to minimum height, check that clear identification is still possible and legibility is adequate. Available light, user distance, and possible operating conditions as factors during size selection should also be considered.

Recommended minimum symbol size is (6 mm)².

L.2.4 Use of colour

In general, the graphic form of a symbol reproduced in black on white or white on black should be sufficient for its identification.

For the purposes of these symbols, adequate contrast between symbol and background is most important. As long as the symbol is clearly delineated and fully legible, actual colour

selection is not mandatory. Be aware that certain colours, such as red, orange, and yellow are designated as safety-alerting colours.

L.3 Symbols

L.3.1 General

This clause presents the symbols along with their reference number, function keyword or phrase, application and source.

L.3.2 Letter symbols

Table L.1 gives a list of letters, which may be used in a symbol.

Table L.1 – Letters used as symbols

Function, keyword or phrase	Letter	Unit
Amperage	I	A
Conventional welding current	I_2	A
Conventional welding voltage	U_2	V
Diameter	\varnothing	mm
Duty cycle; duty factor	X	%
Efficiency	η	%
Frequency	f	Hz
Idle state energy consumption	P_i	W.h/h
Power	P	W
Rated no load current	I_0	A
Rated no load voltage	U_0	V
Rated supply current	I_1	A
Rated supply voltage	U_1	V
Speed of rotation	n	min ⁻¹
Supply power (supply energy consumption)	P_1	W (W.h/h)
Temperature (change)	T	°C (K)
Time	t	s, min, h
Voltage	U	V
Rated peak voltage	U_p	V
Standby energy consumption	P_s	W.h/h

L.3.3 Graphical symbols

L.3.3.1 Symbols to describe the switch or control

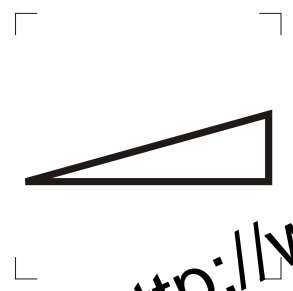

N°	SOURCE	SYMBOL	FUNCTION, KEYWORD OR PHRASE	APPLICATION
1.	IEC 60417-5004		Variability	To identify an increase or decrease of a quantity continuously NOTE Symbol can be curved.

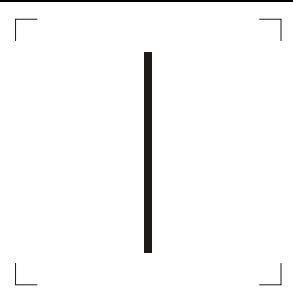
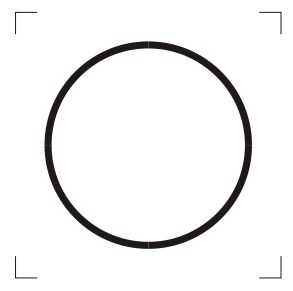
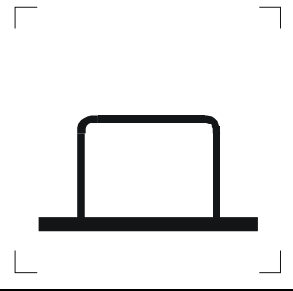

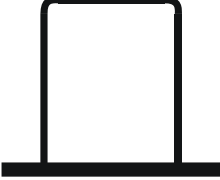
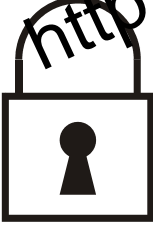
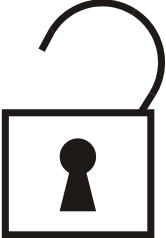

L.3.3.2 Symbols to indicate switch or control position

N°	SOURCE	SYMBOL	FUNCTION, KEYWORD OR PHRASE	APPLICATION
2.	IEC 60417-5007		On (power)	To indicate connection to the mains, at least for mains switches or their positions, and all those cases where safety is involved
3.	IEC 60417-5008		Off (power)	To indicate disconnection from the mains, at least for mains switches or their positions, and all those cases where safety is involved
4.	IEC 60417-5268		IN-position of a bistable push control	To identify the IN-position of a push control where the push control is used to energize or deenergize a function NOTE 1 This symbol is used together with a function symbol.

N°	SOURCE	SYMBOL	FUNCTION, KEYWORD OR PHRASE	APPLICATION
5.	IEC 60417-5269		OUT-position of a bi-stable push control	To identify the OUT-position of a push control where the push control is used to energize or de-energize a function NOTE 2 This symbol is used together with a function symbol.
6.	IEC 60417-5569		Locked	To identify a locked function or control NOTE 3 This symbol is used together with a function symbol.
7.	IEC 60417-5570		Unlocked	To identify an unlocked function or control NOTE 4 This symbol is used together with a function symbol.

L.3.3.3 Symbols to indicate switch or control function

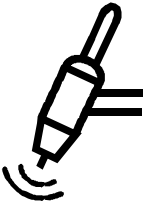
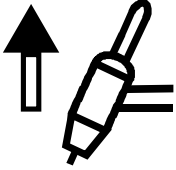

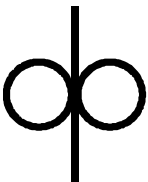
N°	SOURCE	SYMBOL	FUNCTION, KEYWORD OR PHRASE	APPLICATION
8.			Continuous welding	To identify a continuous welding
9.			Intermittent (stitch) welding	To identify an intermittent (stitch) welding

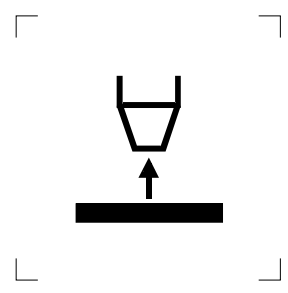
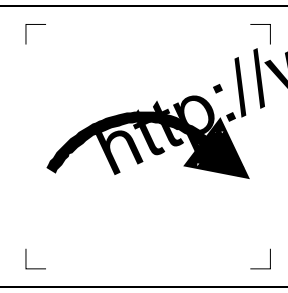
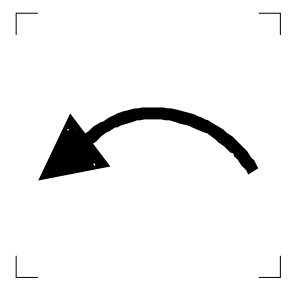
N°	SOURCE	SYMBOL	FUNCTION, KEYWORD OR PHRASE	APPLICATION
10.	ISO 7000-0468		Arc spot welding	To identify an arc spot welding
11.	ISO 7000-0096		Manual control	To identify the switch position for manual control
12.			Arc striking without contact	To identify a TIG arc striking function which initiates an arc without contact
13.			Arc striking with contact	To identify a TIG arc striking function which initiates an arc with contact
14.			Pilot arc starting	To identify pilot arc starting of a plasma torch
15.	ISO 7000-0474		Purging of air (by gaz)	To identify purging of the air by gas
16.	ISO 7000-0823		Wire feed drive	To identify a wire feeder or wire feed control

N°	SOURCE	SYMBOL	FUNCTION, KEYWORD OR PHRASE	APPLICATION
17.			Wire burnback control	To identify burnback control at the end of the weld
18.	ISO 7000-0004		Direction of continuous rotation (clockwise)	To identify a direction of continuous rotation
19.	ISO 7000-0004		Direction of continuous rotation (anti clockwise)	To identify a direction of continuous rotation

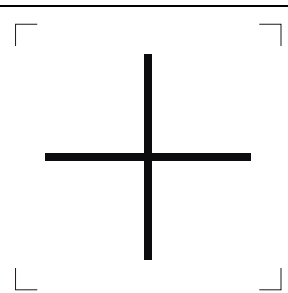
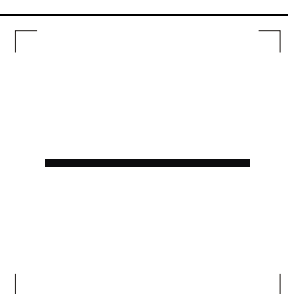
L.3.3.4 Symbols to indicate electrical connection

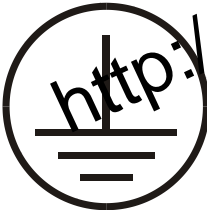
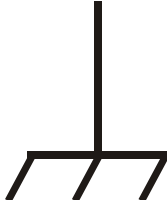
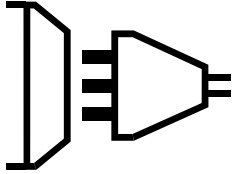

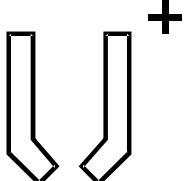
N°	SOURCE	SYMBOL	FUNCTION, KEYWORD OR PHRASE	APPLICATION
20.	IEC 60417-5005		Plus; plus pole	To identify positive polarity
21.	IEC 60417-5006		Minus; minus pole	To identify negative polarity

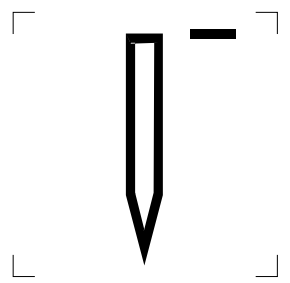
N°	SOURCE	SYMBOL	FUNCTION, KEYWORD OR PHRASE	APPLICATION
22.	IEC 60417-5017		Earth (ground)	<p>To identify the earth (ground) connection</p> <p>NOTE 1 Not for a protective earth connection</p>
23.	IEC 60417-5019		Protective earth (ground)	To identify the equipment connection point for the protective earth (ground)
24.	IEC 60417-5020		Frame or chassis	<p>To identify the frame or chassis connection</p> <p>NOTE 2 Not for a protective earth connection.</p>
25.	IEC 60417-5939		Power supply type of electric device	<p>On device or equipment for example on arc welding equipment.</p> <p>To identify the type of power supply, for example socket-outlet with 3-poles.</p>
26.	ISO 7000-0453		Workpiece connection	To identify a workpiece connection
27.	ISO 7000-0483		Connection to the nozzle of a plasma torch (positive terminal)	To identify a plasma torch connection – nozzle connection to positive terminal

N°	SOURCE	SYMBOL	FUNCTION, KEYWORD OR PHRASE	APPLICATION
28.	ISO 7000-0482		Connection to the electrode of a plasma torch (negative terminal)	To identify a plasma torch connection – electrode connection to negative terminal

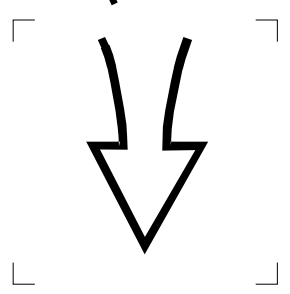
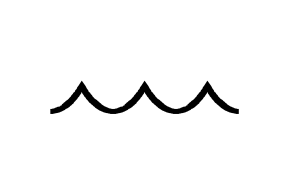
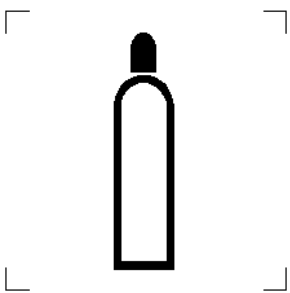
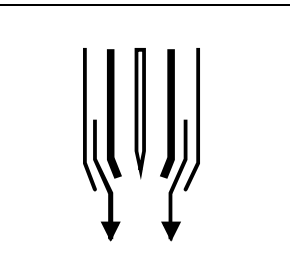



L.3.3.5 Symbols to indicate fluid connection or control

N°	SOURCE	SYMBOL	FUNCTION, KEYWORD OR PHRASE	APPLICATION
29.			Air flow	To indicate air flow
30.	ISO 7000-0536		Liquid	Liquid, e.g coolant
31.			Gas supply	To identify a gas supply connection or control
32.	ISO 7000-0481		Plasma shielding gas	To identify plasma shielding gas connection or control

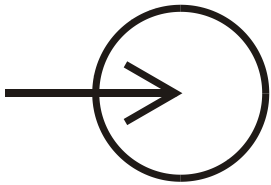
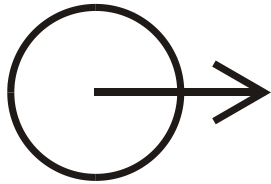
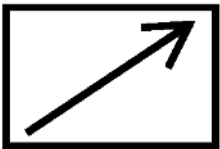

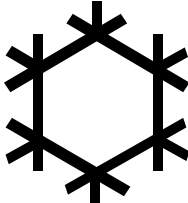
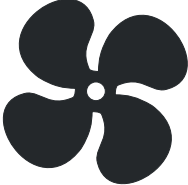

N°	SOURCE	SYMBOL	FUNCTION, KEYWORD OR PHRASE	APPLICATION
33.	ISO 7000-0480		Plasma gas	To identify plasma gas connection or control
34.			Air pressure	To identify air pressure function or control

L.3.3.6 Symbols to indicate auxiliary device, connection or function

N°	SOURCE	SYMBOL	FUNCTION, KEYWORD OR PHRASE	APPLICATION
35.	IEC 60417-5034		Input	To identify input connection or control
36.	IEC 60417-5035		Output	To identify output connection or control
37.	ISO 7000-0093		Remote	To identify a remote control, connection or function

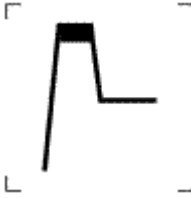

N°	SOURCE	SYMBOL	FUNCTION, KEYWORD OR PHRASE	APPLICATION
38.			Foot control	To identify a foot control device, connection or function
39.			Panel / Local	To identify a panel/local function or control
40.			Hopper (powder, flux)	To identify a flux (powder) hopper
41.	ISO 7000-0027		Cooling	To identify a cooling device, connection or control
42.	ISO 7000-0089		Ventilating or air circulating fan	To identify a ventilating or air circulating fan
43.			Air filter	To identify an air filter

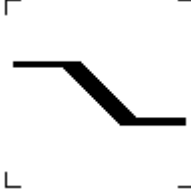
L.3.3.7 Symbols to indicate control of the welding amperage/voltage

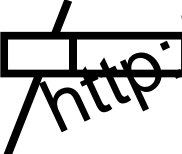
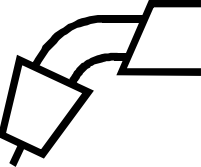
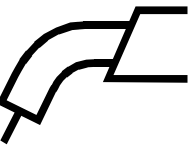
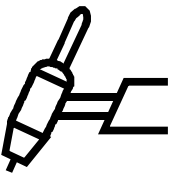
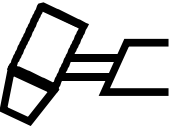
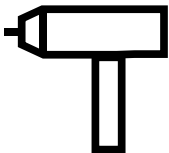

N°	SOURCE	SYMBOL	FUNCTION, KEYWORD OR PHRASE	APPLICATION
44.	IEC 60417-6005		Pulse background	To indicate a control of pulse background NOTE 1 Control is identified by one letter chosen in Table L.1.
45.	IEC 60417-6006		Pulse peak	To indicate a control of pulse peak NOTE 2 Control is identified by one letter chosen in Table L.1.
46.	IEC 60417-6007		Hot start	To indicate a control or function increasing the energy at the beginning of the weld NOTE 3 Control is identified by one letter chosen in Table L.1.
47.	IEC 60417-6008		Slope (increasing)	To indicate a control or function regulating the increase of a value NOTE 4 Control is identified by one letter chosen in Table L.1.
48.	IEC 60417-6009		Slope (decreasing)	To indicate a control or function regulating the decrease of a value NOTE 5 Control is identified by one letter chosen in Table L.1.

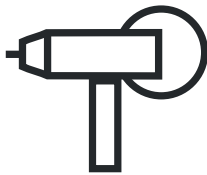

L.3.3.8 Symbols to indicate type of torch

N°	SOURCE	SYMBOL	FUNCTION, KEYWORD OR PHRASE	APPLICATION
49.			Manual metal arc welding electrode holder	To identify an electrode holder
50.			Air carbon arc gouging electrode holder	To identify an air carbon arc gouging electrode holder
51.			MIG/MAG Torch	To identify a MIG/MAG torch
52.			Self shielded flux cored arc welding torch	To identify a self shielded flux cored arc welding torch without gas shielding
53.			TIG Torch	To identify a TIG torch
54.			Plasma torch	To identify plasma torch for welding, cutting and/or gouging
55.			Motorised gun	To identify a gun incorporating a wire drive system

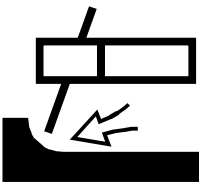

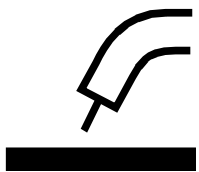

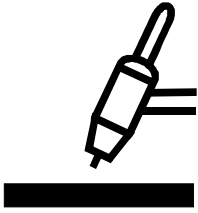

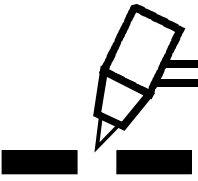
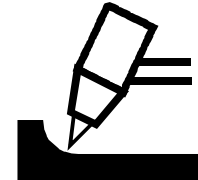
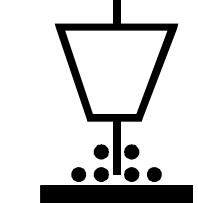
N°	SOURCE	SYMBOL	FUNCTION, KEYWORD OR PHRASE	APPLICATION
56.			Motorised gun with filler wire supply	To identify a gun incorporating a wire drive system and including a filler wire supply
57.			Submerged arc torch	To identify a torch for submerged arc welding

L.3.3.9 Symbols to indicate processes

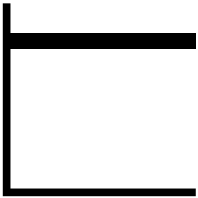
N°	SOURCE	SYMBOL	FUNCTION, KEYWORD OR PHRASE	APPLICATION
58.			MMA welding	To identify MMA welding
59.			Air carbon arc gouging	To identify air carbon arc gouging
60.			MIG/MAG welding	To identify MIG/MAG welding
61.			Flux cored self shielded arc welding	To identify flux cored self shielded arc welding (without gas shielding)

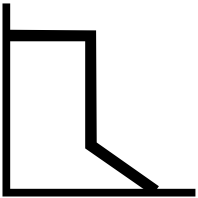
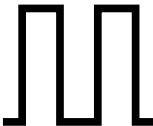

N°	SOURCE	SYMBOL	FUNCTION, KEYWORD OR PHRASE	APPLICATION
62.			TIG welding	To identify TIG welding
63.	ISO 7000-0478		Plasma welding	To identify plasma arc welding
64.	ISO 7000-0479		Plasma cutting	To identify plasma arc cutting
65.			Plasma gouging	To identify plasma gouging
66.			Submerged arc welding	To identify submerged arc welding





L.3.3.10 Symbols to indicate control of welding characteristics

N°	SOURCE	SYMBOL	FUNCTION, KEYWORD OR PHRASE	APPLICATION
67.	ISO 7000-0455		Flat characteristic	To identify a substantially constant voltage characteristic
68.	ISO 7000-0454		Drooping characteristic	To identify a substantially drooping current characteristic
69.			Arc force	To indicate a control or function increasing current when low arc voltage is detected
70.			Pulsed	To identify a pulse value
71.			Variable inductance	To identify a variable inductance function or control
72.			High inductance or inductance	To identify inductance or used with other inductance symbols, high inductance
73.			Medium inductance	To identify medium inductance connection, function or control

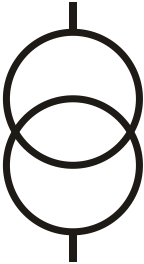

N°	SOURCE	SYMBOL	FUNCTION, KEYWORD OR PHRASE	APPLICATION
74.			Low inductance	To identify low inductance connection, function or component

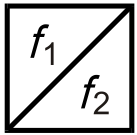
L.3.3.11 Symbols to describe the type of power source



N°	SOURCE	SYMBOL	FUNCTION, KEYWORD OR PHRASE	APPLICATION
75.	IEC 60417-5031		Direct current (DC)	To identify that power source delivers direct current
76.	IEC 60417-5032		Alternating current (AC)	To identify that power source delivers alternating current NOTE Symbol can be mixed with a number to indicate the number of phases.
77.	IEC 60417-5033		Direct and alternating current	To identify that the power source delivers both direct and alternating current
78.	IEC 60417-5156		Transformer	To identify a transformer



N°	SOURCE	SYMBOL	FUNCTION, KEYWORD OR PHRASE	APPLICATION
79.	ISO 7000-1153		Generator	To identify a generator
80.	ISO 7000-0796		Engine	To identify an engine
81.	ISO 7000-0147		Electric motor	To identify an electric motor
82.	IEC 60417-5970		Inverter	To identify a frequency conversion stage function
83.	IEC 60417-5194		DC/AC-converter	To identify a DC/AC-converter and its associated terminals and controls

L.3.3.12 Symbols to indicate protective component and class of protection

N°	SOURCE	SYMBOL	FUNCTION, KEYWORD OR PHRASE	APPLICATION
84.			Suitable for welding in an environment with increased risk of electric shock	To identify a welding power source suitable for welding in an environment with increased risk of electric shock
85.	IEC 60417-5172		Class II equipment	To identify class II equipment
86.	IEC 60417-5016		Fuse	To indicate a fuse

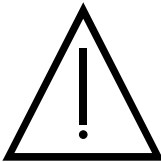
L.3.3.13 Symbols to inform users

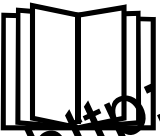

N°	SOURCE	SYMBOL	FUNCTION, KEYWORD OR PHRASE	APPLICATION
87.	IEC 60417-5036		Dangerous voltage	To identify a dangerous voltage
88.	ISO 7000-0228		Disturbance	To identify a disturbance of the correct operation
89.	ISO 7000-0434A		Caution	To make operator aware of general hazard.

N°	SOURCE	SYMBOL	FUNCTION, KEYWORD OR PHRASE	APPLICATION
90.	IEC 60417-5041		Caution, hot surface	To indicate that the marked item can be hot and should not be touched without taking care
91.			Read instruction manual	To identify that the instruction manual should be read
92.			Temperature indication	To identify the temperature indication for example excess temperature warning light

L.4 Examples of combinations of symbols

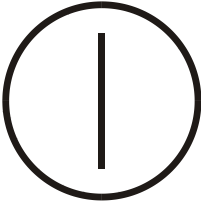
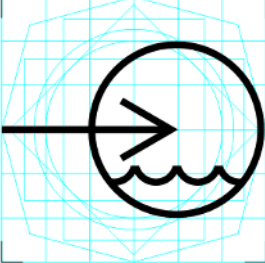
This clause gives examples of combination of symbols which can be used on arc welding and allied processes equipment.

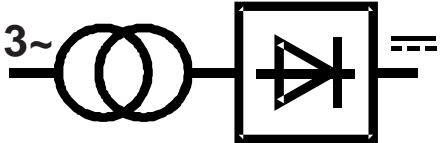
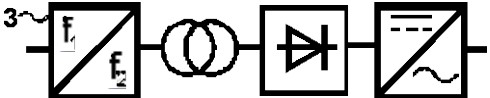
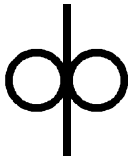
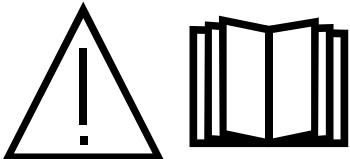
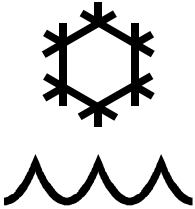
SYMBOL	FUNCTION, KEYWORD OR PHRASE	APPLICATION
 IEC 60417-5010	On/off (push-push)	To indicate connection to or disconnection from the mains, at least for mains switches or their position, and all those cases where safety is involved. Each position, ON or OFF, is a stable position.
 IEC 60417-6024	Input of liquid	To identify input of liquid

SYMBOL	FUNCTION, KEYWORD OR PHRASE	APPLICATION
	<p>Three-phase transformer-rectifier</p>	<p>To indicate welding power source symbol on the rating plate</p>
	<p>Inverter power source AC/DC</p>	<p>To indicate welding power source symbol on the rating plate</p>
	<p>Slow wire feed start</p>	<p>To identify the slow advance of wire towards the workpiece at the start of the weld</p>
	<p>Caution ! Read the instruction manual</p>	<p>To indicate a hazard and identify that the instruction manual should be read</p>
 <p>ISO 7000-0544</p>	<p>Cooling water</p>	
	<p>Variability and OFF position</p>	<p>To identify a continuous increase/decrease of a quantity and an off position of a control</p>
 <p>ISO 7000-1469, modified</p>	<p>MIG/MAG spot welding</p>	<p>To identify MIG/MAG spot welding</p>

SYMBOL	FUNCTION, KEYWORD OR PHRASE	APPLICATION
	Upslope time	To indicate a control of upslope time

L.5 Examples of control panels

This clause (see Figures L.1 to L.8) gives examples of control panels for arc welding and allied processes equipment.

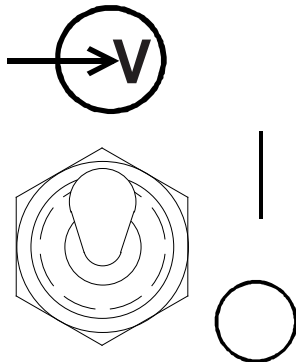

IEC 1164/03

Figure L.1 – Input voltage power switch

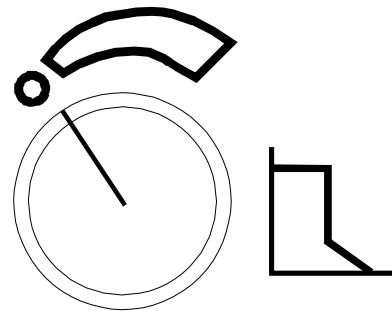

IEC 1165/03

Figure L.2 – Arc force control potentiometer

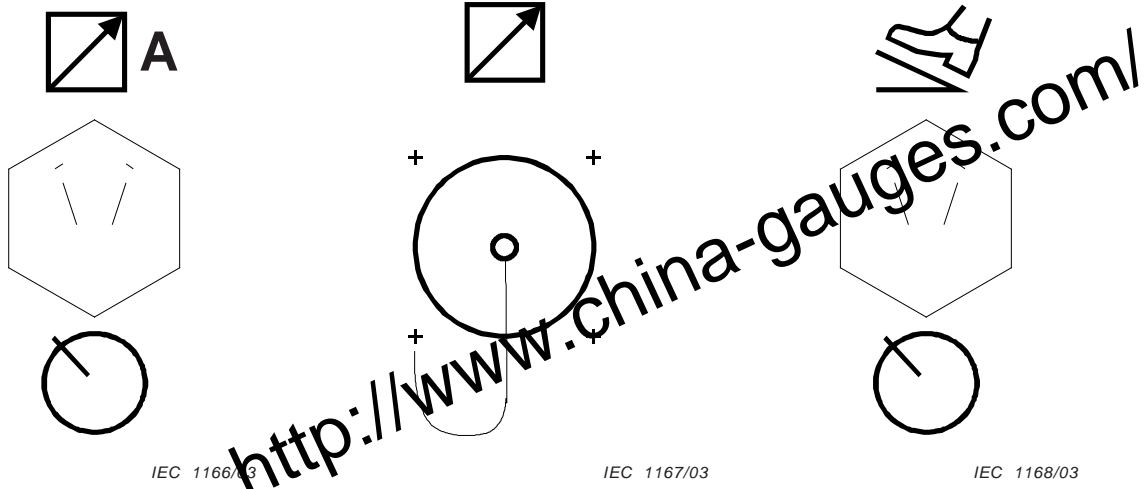

Figure L.3 – Remote receptacle and selector switches

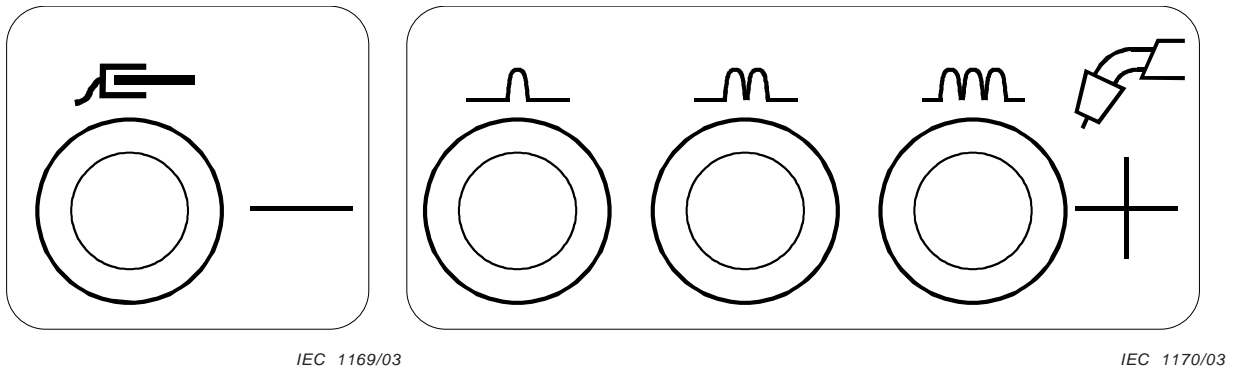

Figure L.4 – Terminals with inductance selector for MIG/MAG welding

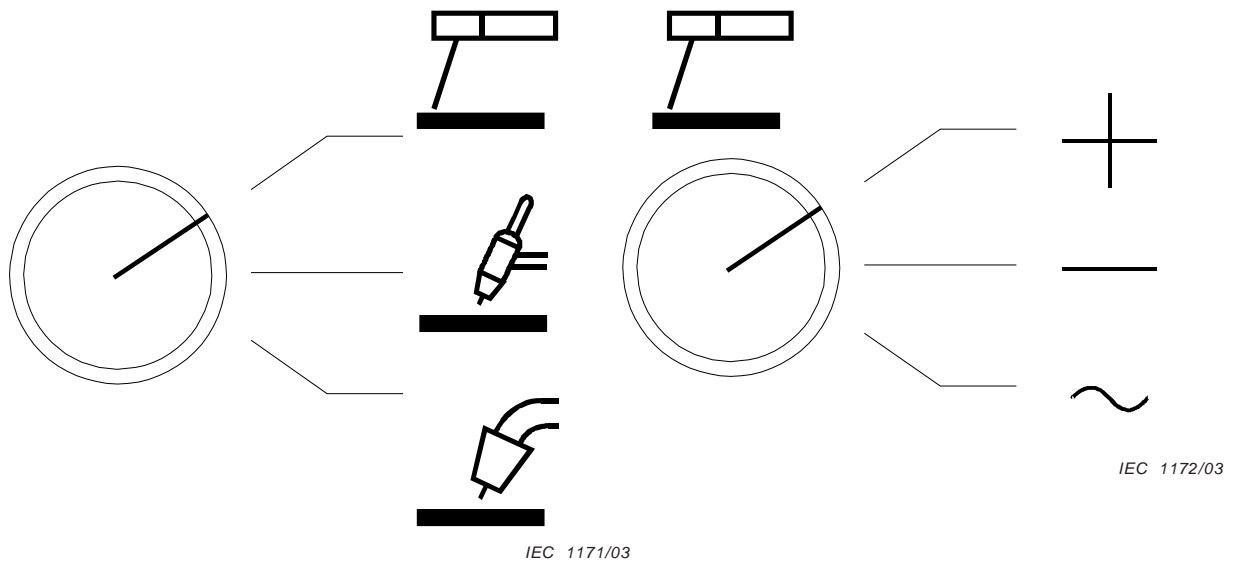
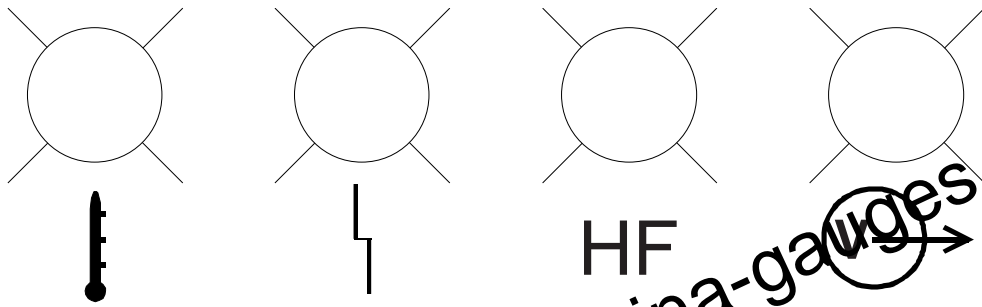

Figure L.5 – Process switch
(MMA, TIG, MIG)

Figure L.6 – Selector switch
on AC/DC equipment



IEC 1173/03

Figure L.7 – Panel indicator lights (overheat, fault, arc striking, output voltage)

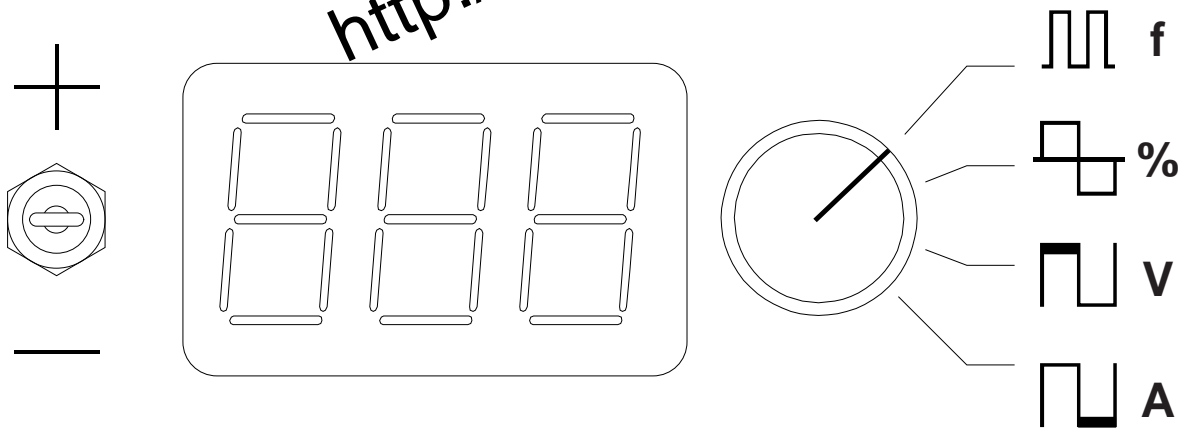

IEC 1174/03

Figure L.8 – Setting pulsing parameters using digital display

Annex M (informative)

Efficiency

Efficiency information may be optionally supplied to the customer (see 3.17). If supplied, the following data should be given:

- a) supply energy consumption at the rated output at 100 % duty cycle (measured in Wh/h);
- b) idle state energy consumption (measured in Wh/h);
- c) standby energy consumption (measured in Wh/h);
- d) efficiency calculated at the rated output at 100 % duty cycle (expressed as percentage).

To ensure repeatability and data accuracy the following method shall be used:

- e) Accuracy of measuring instruments, including wattmeter, shall conform to Clause 5.
- f) Supply network shall conform to Annex G.
- g) Efficiency is rounded to two significant figures. Decimal places are not used.
- h) The efficiency measured on any equipment shall not be less than the reported value. Idle state energy consumption shall not be greater than the reported value.
- i) Efficiency depends on output load, supply network voltage (for equipment with multiple input voltages) and may depend on operating mode. These variables must be reported when expressing efficiency performance.
- j) Efficiency is measured:
 - at conventional welding conditions (see 3.17);
 - at thermal equilibrium (see 3.44);
 - halfway into the load cycle for duty cycles less than 100 %;
 - with no-load on auxiliary power supplies (see 11.5 and 11.6).
- k) Idle state energy consumption is measured:
 - at thermal equilibrium;
 - with ancillary equipment disconnected or turned off;
 - after equipment switches into low energy mode (if equipped).

Efficiency:
$$\eta = \frac{U_2 I_2}{P_1}$$

where:

I_1 is the rated supply current;

P_1 is the supply energy consumption;

U_2 is the conventional welding voltage.

NOTE This ratio, lying between 0 and 1, is expressed as a percentage.

Annex N
(normative)

Touch current measurement in fault condition

For measuring the touch current in fault condition, the measuring network in accordance with Figure N.1 and the appropriate configurations in Figures N.2 and N.3 shall be used with an appropriate measuring device.

Caution! A expert shall perform this test. The protective conductor is disabled for this test.

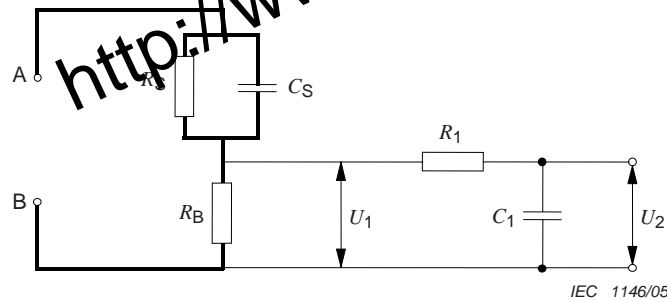

Key

A, B	Test terminals	C_S	0,22 μ F
R_S	1 500 Ω	R_1	10 000 Ω
R_B	500 Ω	C_1	0,022 μ F
U_1	r.m.s. voltage	U_2	peak voltage

$$\text{Weighted touch current (perception/reaction)} = \frac{U_2}{500} \text{ (peak value)}$$

Figure N.1 – Measuring network for weighted touch current

For three-phase equipment, touch current in fault condition is measured with the switches (l) and (n) in the closed position and switch (e) in the open position. The measurement is then repeated with each of the switches (l) and (n) opened one by one, with the other switches closed, except switch (e). The measurements are similar for single-phase equipment, except that they shall be repeated for each position of the polarity switch (p).

The manufacturer shall identify the configuration (TN, TT, star IT, etc.) to which its equipment is intended to be connected in its final application. The equipment under test shall be tested to those identified configurations or the worst-case configuration.

The use of isolating transformer (T) is optional. When not used, safety precautions shall be taken to protect the test operator from any hazardous voltage on the enclosure and other accessible conductive parts of the equipment.

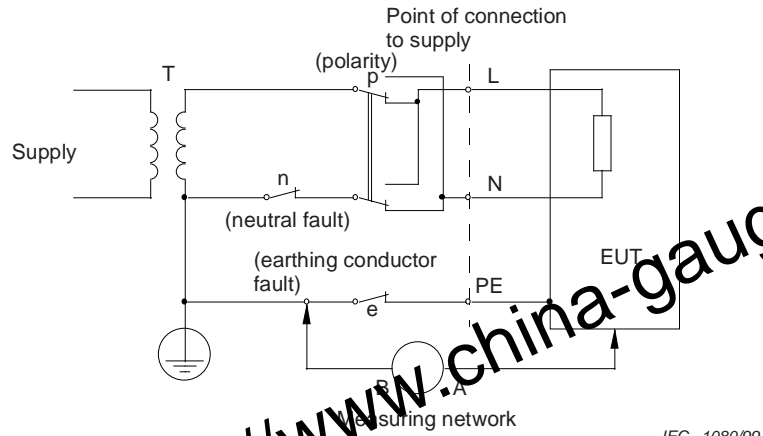

a) Single phase equipment on star TN or TT system IEC 1080/99

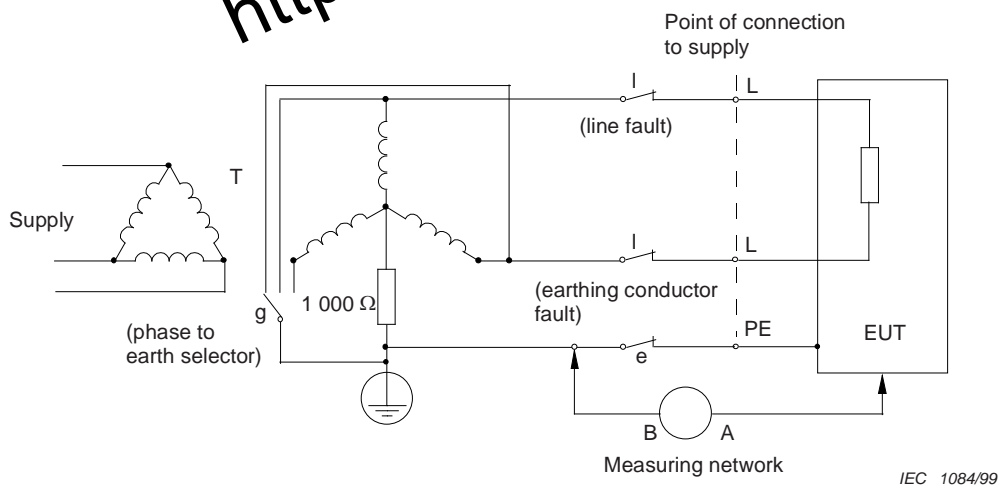

b) Single phase equipment connected line-to-line on star TN or TT system IEC 1084/99

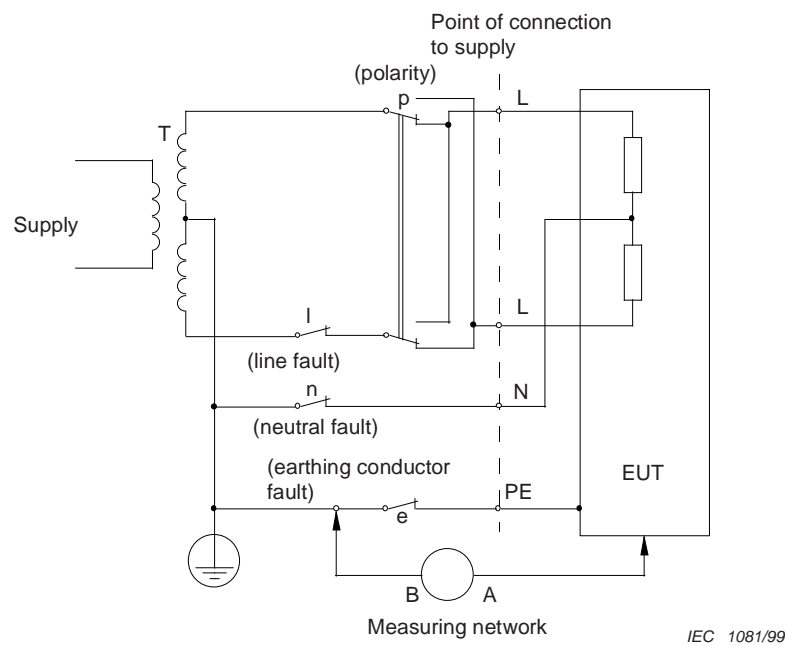

c) Single phase equipment on centre-earthed TN or TT system IEC 1081/99

<http://www.china-gauges.com/>

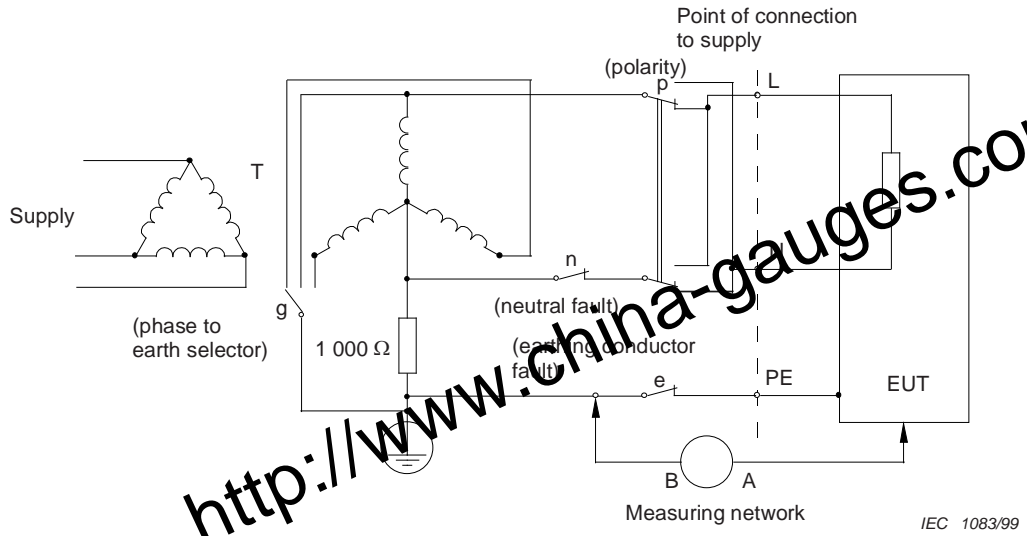

d) Single phase equipment connected line-to-neutral on star IT system

Figure N.2 – Diagram for touch current measurement on fault condition at operating temperature for single-phase connection of appliances other than those of class II

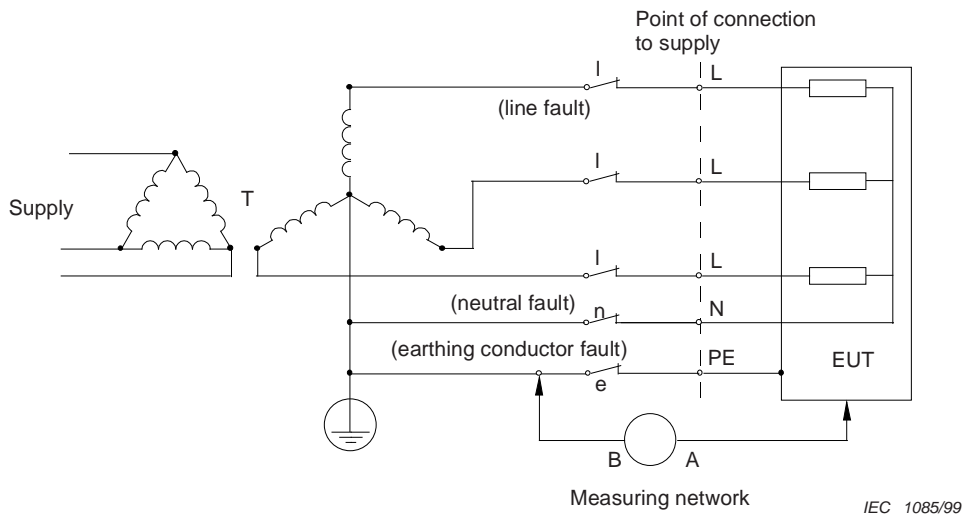

a) Three-phase equipment on star TN or TT system

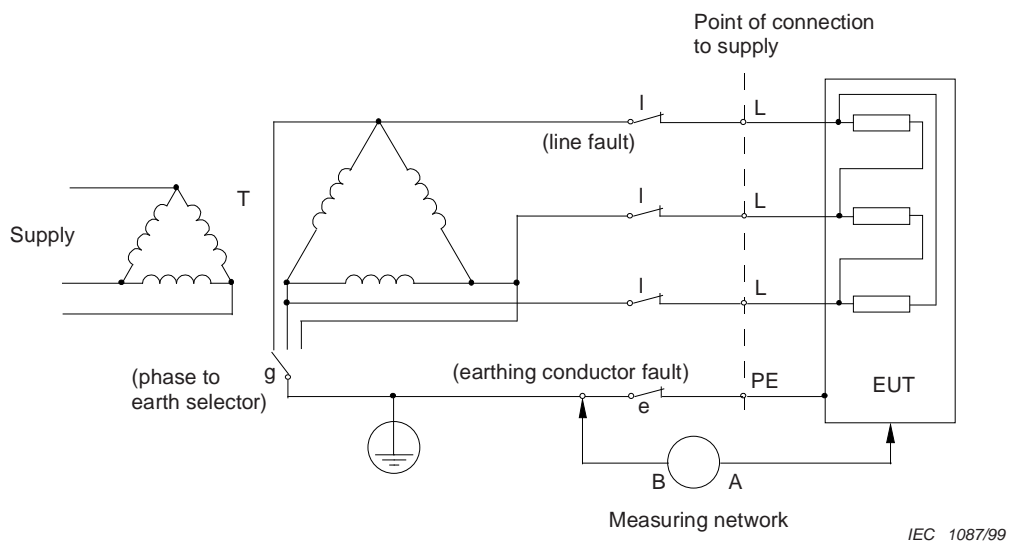

b) Three-phase equipment on unearthed three-phase three-line system

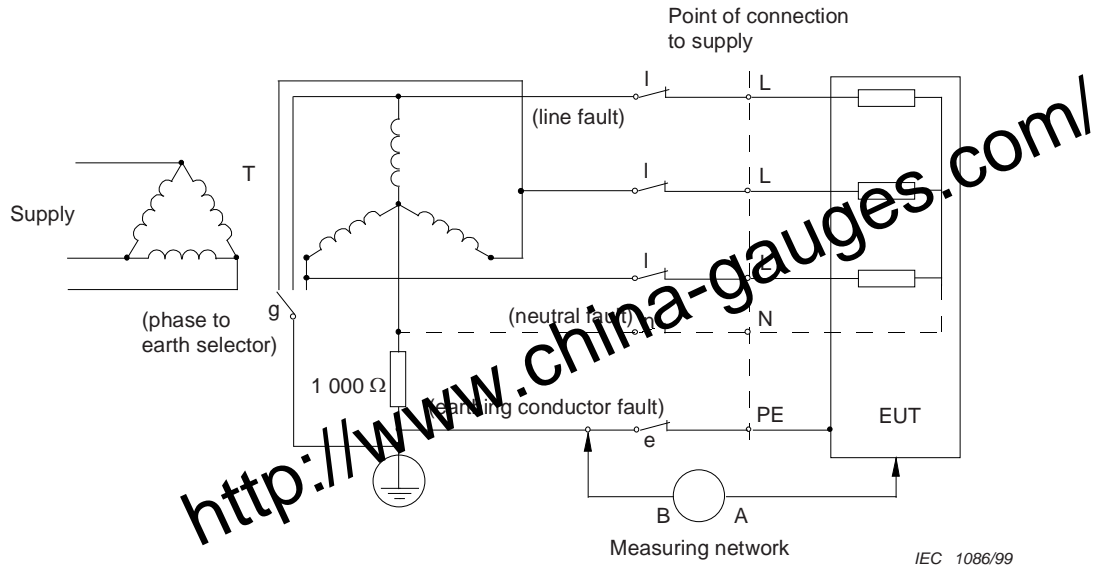

c) Three-phase equipment on star IT system

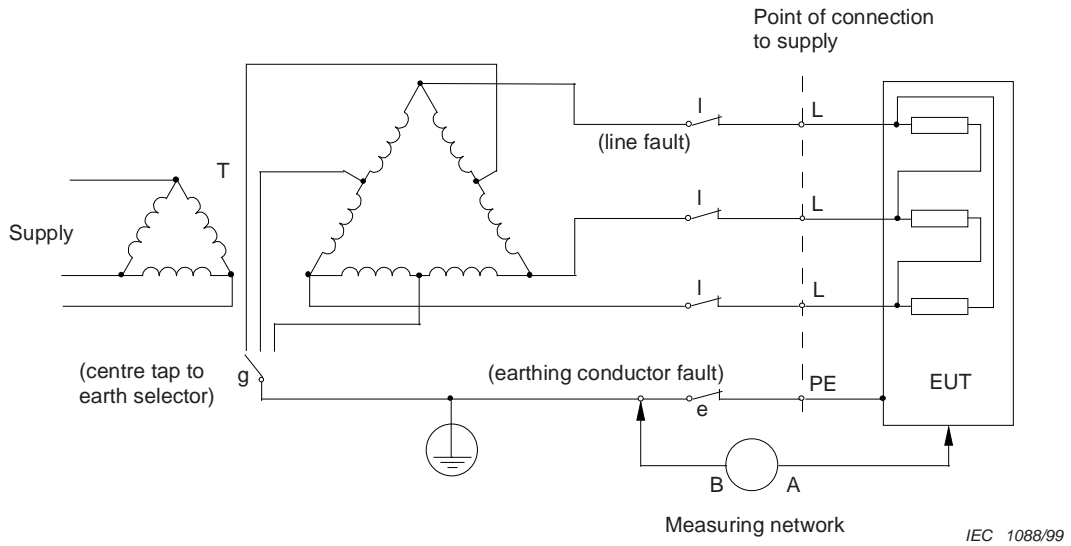

d) Three-phase equipment on earthed centred three-phase three-line system

Figure N.3 – Diagram for touch current measurement on fault condition for three-phase four-wire system connection of appliances other than those of class II

Bibliography

IEC 60038:2009, *IEC standard voltages*

IEC 60050-195:1998, *International Electrotechnical Vocabulary (IEV) – Part 195: Earthing and protection against electric shock*

IEC 60050-811:1991, *International Electrotechnical Vocabulary – Chapter 811: Electric traction*

IEC 60050-826:2004, *International Electrotechnical Vocabulary – Part 826: Electrical installations*

IEC 60076-12, *Power transformers – Part 12: Loading guide for dry-type power transformers*

IEC 60085, *Electrical insulation – Thermal evaluation and designation*

IEC 60204-1, *Safety of machinery – Electrical equipment of machines – Part 1: General requirements*

IEC 60309-1, *Plugs, socket-outlets and couplers for industrial purposes – Part 1: General requirements*

IEC/TR 60755:2008, *General requirements for residual current operated protective devices*

IEC 60950-1, *Information technology equipment – Safety – Part 1: General requirements*

IEC 60974-6, *Arc welding equipment – Part 6: Limited duty equipment*

IEC 60974-9, *Arc welding equipment – Part 9: Installation and use*

IEC 60974-10, *Arc welding equipment – Part 10: Electromagnetic compatibility (EMC) requirements*

IEC 60974-12, *Arc welding equipment – Part 12: Coupling devices for welding cables*

IEC 61558-1, *Safety of power transformers, power supplies, reactors and similar products – Part 1: General requirements and tests*

IEC 62079, *Preparation of instructions – Structuring, content and presentation*

ISO 3864-1, *Graphical symbols – Safety colours and safety signs – Part 1: Design principles for safety signs and safety markings*

ISO 7000:2004, *Graphical symbols for use on equipment – Index and synopsis*

ISO 13732-1, *Ergonomics of the thermal environment – Methods for the assessment of human responses to contact with surfaces – Part 1: Hot surfaces*

ISO 17846, *Welding and allied processes – Health and safety – Wordless precautionary labels for equipment and consumables used in arc welding and cutting*

CSA C22.1, *Canadian electrical code*

HD 22.1 S4, *Cables of rated voltages up to and including 450/750 V and having crosslinked insulation – Part 1: General requirements*

HD 22.6 S2, *Rubber Insulated Cables of Rated Voltages up to and Including 450/750 V – Part 6: Arc Welding Cables²*

NFPA 70, *National Electrical code*

US Code of Federal Regulations, Title 16: *Commercial Practices – Parts 1407: Portable Generators: Requirements to provide performance and technical data by labelling*

<http://www.china-gauges.com/>

² This document will be replaced by prEN 50525-2-81:2008.

<http://www.china-gauges.com/>

British Standards Institution (BSI)

BSI is the independent national body responsible for preparing British Standards and other standards-related publications, information and services. It presents the UK view on standards in Europe and at the international level.

BSI is incorporated by Royal Charter. British Standards and other standardisation products are published by BSI Standards Limited.

Revisions

British Standards and PASs are periodically updated by amendment or revision. Users of British Standards and PASs should make sure that they possess the latest amendments or editions.

It is the constant aim of BSI to improve the quality of our products and services. We would be grateful if anyone finding an inaccuracy or ambiguity while using British Standards would inform the Secretary of the technical committee responsible, the identity of which can be found on the inside front cover. Similarly for PASs, please notify BSI Customer Services.

Tel: +44 (0)20 8996 9001 Fax: +44 (0)20 8996 7001

BSI offers BSI Subscribing Members an individual updating service called PLUS which ensures that subscribers automatically receive the latest editions of British Standards and PASs.

Tel: +44 (0)20 8996 7669 Fax: +44 (0)20 8996 7001

Email: plus@bsigroup.com

Buying standards

You may buy PDF and hard copy versions of standards directly using a credit card from the BSI Shop on the website www.bsigroup.com/shop. In addition all orders for BSI, international and foreign standards publications can be addressed to BSI Customer Services.

Tel: +44 (0)20 8996 9001 Fax: +44 (0)20 8996 7001

Email: orders@bsigroup.com

In response to orders for international standards, BSI will supply the British Standard implementation of the relevant international standard, unless otherwise requested.

Information on standards

BSI provides a wide range of information on national, European and international standards through its Knowledge Centre.

Tel: +44 (0)20 8996 7004 Fax: +44 (0)20 8996 7005

Email: knowledgecentre@bsigroup.com

BSI Subscribing Members are kept up to date with standards developments and receive substantial discounts on the purchase price of standards. For details of these and other benefits contact Membership Administration.

Tel: +44 (0)20 8996 7002 Fax: +44 (0)20 8996 7001

Email: membership@bsigroup.com

Information regarding online access to British Standards and PASs via British Standards Online can be found at www.bsigroup.com/BSOL

Further information about British Standards is available on the BSI website at www.bsi-group.com/standards

Copyright

All the data, software and documentation set out in all British Standards and other BSI publications are the property of and copyrighted by BSI, or some person or entity that own copyright in the information used (such as the international standardisation bodies) has formally licensed such information to BSI for commercial publication and use. Except as permitted under the Copyright, Designs and Patents Act 1988 no extract may be reproduced, stored in a retrieval system or transmitted in any form or by any means – electronic, photocopying, recording or otherwise – without prior written permission from BSI. This does not preclude the free use, in the course of implementing the standard, of necessary details such as symbols, and size, type or grade designations. If these details are to be used for any other purpose than implementation then the prior written permission of BSI must be obtained. Details and advice can be obtained from the Copyright & Licensing Department.

Tel: +44 (0)20 8996 7070

Email: copyright@bsigroup.com

BSI

389 Chiswick High Road London W4 4AL UK

Tel +44 (0)20 8996 9001

Fax +44 (0)20 8996 7001

www.bsigroup.com/standards