

# Low-voltage switchgear and controlgear —

Part 6-2: Multiple function  
equipment — Control and protective  
switching devices (or equipment) (CPS)

The European Standard EN 60947-6-2:2003, incorporating  
amendment A1:2007, has the status of a British Standard

ICS 29.120.40; 29.130.20

## National foreword

This British Standard is the official UK implementation of EN 60947-6-2:2003, incorporating amendment A1:2007. It is identical with IEC 60947-6-2:2002, incorporating amendment 1:2007. It supersedes BS EN 60947-6-2:1993 which is withdrawn.

The start and finish of text introduced or altered by amendment is indicated in the text by tags **A1** **A1**. Tags indicating changes to IEC text carry the number of the IEC amendment. For example, text altered by IEC amendment 1 is indicated in the text by **A1** **A1**.

The UK participation in its preparation was entrusted by Technical Committee PEL/17, Switchgear, controlgear, and LV LV co-ordination, to Subcommittee PEL/17/2, LV switchgear and controlgear.

A list of organizations represented on this subcommittee can be obtained on request to its secretary.

This publication does not purport to include all the necessary provisions of a contract. Users are responsible for its correct application.

**Compliance with a British Standard cannot confer immunity from legal obligations.**

This British Standard was published under the authority of the Standards Policy and Strategy Committee on 26 June 2003

### Amendments issued since publication

Amd. No.	Date	Comments
17136	29 June 2007	See national foreword

© BSI 2007

ISBN 978 0 580 59191 4

EUROPEAN STANDARD  
NORME EUROPÉENNE  
EUROPÄISCHE NORM

**EN 60947-6-2**

June 2003

**+A1**

March 2007

ICS 29.120.40; 29.130.20

Supersedes EN 60947-6-2:1993 + A1:1997 + A2:1999

English version

**Low-voltage switchgear and controlgear  
Part 6-2: Multiple function equipment –  
Control and protective switching devices  
(or equipment) (CPS)  
(IEC 60947-6-2:2002)**

Appareillage à basse tension  
Partie 6-2: Matériels à fonctions multiples –  
Appareils (ou matériel) de connexion de  
commande et de protection (ACP)  
(CEI 60947-6-2:2002)

Niederspannungsschaltgeräte  
Teil 6-2: Mehrfunktions-Schaltgeräte –  
Steuer- und Schutz-Schaltgeräte (CPS)  
(IEC 60947-6-2:2002)

This European Standard was approved by CENELEC on 2002-09-01. CENELEC members are bound to comply with the CEN/CENELEC Internal Regulations which stipulate the conditions for giving this European Standard the status of a national standard without any alteration.

Up-to-date lists and bibliographical references concerning such national standards may be obtained on application to the Central Secretariat or to any CENELEC member.

This European Standard exists in three official versions (English, French, German). A version in any other language made by translation under the responsibility of a CENELEC member into its own language and notified to the Central Secretariat has the same status as the official versions.

CENELEC members are the national electrotechnical committees of Austria, Belgium, Czech Republic, Denmark, Finland, France, Germany, Greece, Hungary, Iceland, Ireland, Italy, Luxembourg, Malta, Netherlands, Norway, Portugal, Slovakia, Spain, Sweden, Switzerland and United Kingdom.

**CENELEC**

European Committee for Electrotechnical Standardization  
Comité Européen de Normalisation Electrotechnique  
Europäisches Komitee für Elektrotechnische Normung

**Central Secretariat: rue de Stassart 35, B - 1050 Brussels**

## Foreword

The text of document 17B/1188/FDIS, future amendment to IEC 60947-6-2:1992, prepared by SC 17B, Low-voltage switchgear and controlgear, of IEC TC 17, Switchgear and controlgear, was submitted to the IEC-CENELEC parallel vote and was approved by CENELEC as amendment A3 to EN 60947-6-2:1993 on 2002-09-01.

The text of this document, together with that of IEC 60947-6-2:2002 and its amendments 1:1997 and 2:1998, was published by IEC as the second edition of IEC 60947-6-2 in October 2002. According to a decision of principle taken by the Technical Board of CENELEC, the approval of EN 60947-6-2:1993/A3 has been converted into the approval of a new EN 60947-6-2.

This European Standard supersedes EN 60947-6-2:1993 + corrigendum June 1997 + A1:1997 + A2:1999.

The following dates were fixed:

- latest date by which the EN has to be implemented  
at national level by publication of an identical  
national standard or by endorsement (dop) 2003-12-01
- latest date by which the national standards conflicting  
with the EN have to be withdrawn (dow) 2005-09-01

Annexes designated "normative" are part of the body of the standard.  
Annexes designated "informative" are given for information only.  
In this standard, annexes A, C and ZA are normative and annex D is informative.  
Annex ZA has been added by CENELEC.

---

## Endorsement notice

The text of the International Standard IEC 60947-6-2:2002 was approved by CENELEC as a European Standard without any modification.

---

## Foreword to amendment A1

The text of document 17B/1526/FDIS, future amendment 1 to IEC 60947-6-2:2002, prepared by SC 17B, Low-voltage switchgear and controlgear, of IEC TC 17, Switchgear and controlgear, was submitted to the IEC-CENELEC parallel vote and was approved by CENELEC as amendment A1 to EN 60947-6-2:2003 on 2007-03-01.

The following dates were fixed:

- latest date by which the amendment has to be implemented at national level by publication of an identical national standard or by endorsement (dop) 2007-12-01
- latest date by which the national standards conflicting with the amendment have to be withdrawn (dow) 2010-03-01

Annex ZA has been added by CENELEC

---

## Endorsement notice

The text of amendment 1:2007 to the International Standard IEC 60947-6-2:2002 was approved by CENELEC as an amendment to the European Standard without any modification.

---

## CONTENTS

INTRODUCTION .....	9
1 Scope and object .....	10
2 Normative references .....	10
3 Definitions .....	11
3.1 Control and protective switching device (or equipment) (CPS).....	11
3.2 CPS suitable for isolation .....	12
3.3 CPS for motor control and protection .....	12
3.3.1 Direct-on-line CPS .....	12
3.3.2 Reversing CPS .....	12
3.3.3 Two-direction CPS .....	12
3.4 Opening time .....	12
3.5 Phase loss sensitive relay or release (for motor protection).....	13
4 Classification.....	13
5 Characteristics .....	14
5.1 Summary of characteristics.....	14
5.2 Type of CPS.....	14
5.2.1 Number of poles .....	14
5.2.2 Kind of current (a.c. or d.c.) .....	14
5.2.3 Method of operation .....	14
5.2.4 Method of control .....	14
5.2.5 Method of resetting after overload .....	14
5.2.6 Method of rearming after short-circuit.....	14
5.3 Rated and limiting values of the main circuit .....	15
5.3.1 Rated voltages.....	15
5.3.2 Currents and powers.....	15
5.3.3 Rated frequency .....	15
5.3.4 Rated duties .....	15
5.3.5 Normal load and overload characteristics .....	15
5.3.6 Short circuit characteristics .....	16
5.4 Utilization categories .....	16
5.4.1 Standard utilization categories .....	16
5.4.2 Assignment of utilization categories based on the results of tests .....	17
5.4.3 Application of utilization categories for motor control duty.....	18
5.5 Control circuits .....	18
5.6 Auxiliary circuits .....	19

5.7	Relays or releases.....	19
5.7.1	Types of relays or releases .....	19
5.7.2	Characteristic values .....	20
5.7.3	Designation and current setting of overload relays or releases .....	20
5.7.4	Time current characteristics of over current relays or releases .....	20
5.7.5	Influence of ambient air temperature .....	21
6	Product information .....	21
6.1	Nature of information .....	21
6.1.1	Identification .....	21
6.1.2	Characteristics.....	21
6.2	Marking.....	22
6.3	Instructions for installation, operation and maintenance .....	22
7	Normal service, mounting and transport conditions .....	22
8	Constructional and performance requirements .....	23
8.1	Constructional requirements .....	23
8.1.1	Materials .....	23
8.1.2	Current-carrying parts and their connections .....	23
8.1.3	Clearances and creepage distances.....	23
8.1.4	Actuator.....	23
8.1.5	Indication of the contact position .....	23
8.1.6	Additional safety requirements for CPS's suitable for isolation .....	23
8.1.7	Terminals .....	24
8.1.8	Additional requirements for CPS's provided with a neutral pole.....	24
8.1.9	Provisions for protective earthing .....	24
8.1.10	Enclosures for CPS's .....	24
8.2	Performance requirements.....	24
8.2.1	Operating conditions .....	24
8.2.2	Temperature rise .....	30
8.2.3	Dielectric properties.....	32
8.2.4	Performance under no load, normal load and overload conditions.....	32
8.2.5	Ability to make, carry and break short-circuit currents.....	37
8.3	Electromagnetic compatibility (EMC).....	38
8.3.1	General .....	38
8.3.2	Immunity.....	38
8.3.3	Emission.....	39
9	Tests.....	39
9.1	Kind of tests .....	39
9.1.1	General .....	39
9.1.2	Type test .....	39
9.1.3	Routine tests .....	39
9.1.4	Sampling tests .....	39
9.1.5	Special tests.....	39
9.2	Compliance with constructional requirements.....	40

9.3	Compliance with performance requirements.....	40
9.3.1	Test sequences .....	40
9.3.2	General test conditions .....	40
9.3.3	Performance under no load, normal load and overload conditions.....	41
9.3.4	Performance under short-circuit conditions.....	45
9.3.5	EMC tests.....	47
9.4	Test sequences.....	57
9.4.1	Test Sequence I: Temperature-rise, operating limits, dielectric properties .....	59
9.4.2	Test Sequence II: Performance under normal load and overload conditions .....	62
9.4.3	Test Sequence III: Operational performance before and after operating sequences at $I_{cr}$ and "r" current test .....	63
9.4.4	Test Sequence IV: Operational performance before and after operating sequences at $I_{cs}$ .....	64
9.4.5	Test Sequence V: Additional breaking capacity .....	65
9.4.6	Test Sequence VI: Additional test sequence for four-pole CPS's.....	65
9.4.7	Test Sequence VII: Additional test sequence for CPS's intended for use in an individual enclosure .....	66
9.4.8	Test sequence VIII: EMC .....	66
9.5	Routine tests .....	66
9.5.1	General .....	66
9.5.2	Operation and operating limits .....	66
9.5.3	Dielectric tests.....	67
Annex A	(normative) Special tests .....	95
Annex B	Vacant.....	98
Annex C	(normative) Marking and identification of CPS terminals.....	98
Annex D	(informative) Items subject to agreement between manufacturer and user .....	102
Annex E	(informative) Examples of control circuit configurations.....	103
Annex F	(normative) Coordination under short-circuit conditions between a CPS and another short-circuit protective device associated in the same circuit .....	105
Annex G	(normative) Test sequence for CPSs for IT systems.....	114
Annex H	(normative) Extended functions within electronic overload relays or releases ....	116
Annex ZA	(normative) Normative references to international publications with their corresponding European publications .....	121
Figure 1	– Multiple of current setting limits for ambient air temperature time-delay overload relays or releases (see 8.2.1.5.1) .....	67
Figure 2a	– Elevation .....	68
Figure 2b	– Sections A-A and B-B .....	69
Figure 2	– EUT mounted in metallic enclosure – Two-phase poles in series configuration.....	69
Figure 3a	– Elevation .....	70
Figure 3b	– Sections A-A and B-B.....	71
Figure 3	– EUT mounted in metallic enclosure – Three-phase poles in series configuration .....	71
Figure 4a	– Elevation.....	72



Figure 4b – Sections A-A and B-B.....	73
Figure 4 – EUT mounted in metallic enclosure – Three-phase configuration .....	73
Figure 5 – Test circuit for emission tests, immunity to harmonics, current dips, electrostatic discharges and radiated electromagnetic fields – Two-phase poles in series configuration .....	74
Figure 6 – Test circuit for emission tests, immunity to harmonics, current dips, electrostatic discharges and radiated electromagnetic fields – Three-phase poles in series configuration .....	75
Figure 7 – Test circuit for emission tests, immunity to harmonics, current dips, electrostatic discharges and radiated electromagnetic fields – Three-phase configuration .....	76
Figure 8 – Test set-up for the verification of immunity to electrostatic discharges .....	77
Figure 9 – Test set-up for immunity to radiated electromagnetic fields .....	78
Figure 10 – Test set-up for conducted disturbances induced by radio-frequency fields (common mode) – Two-phase poles in series configuration .....	79
Figure 11 – Test set-up for conducted disturbances induced by radio-frequency fields (common mode) – Three-phase poles in series configuration .....	80
Figure 12 – Test set-up for conducted disturbances induced by radio-frequency fields (common mode) – Three-phase configuration.....	81
Figure 13 – Circuit for electrical fast transients/bursts (EFT/B) immunity test – Two-phase poles in series configuration .....	82
Figure 14 – Circuit for electrical fast transients/bursts (EFT/B) immunity test – Three-phase poles in series configuration .....	83
Figure 15 – Circuit for electrical fast transients/bursts (EFT/B) immunity test – Three-phase configuration .....	84
Figure 16 – Test set-up for electrical fast transients/bursts (EFT/B) immunity test.....	85
Figure 17 – Test circuit for the verification of the influence of surges in the main circuit (line-to-earth) – Two-phase poles configuration.....	86
Figure 18 – Test circuit for the verification of the influence of current surges in the main circuit – Two-phase poles configuration.....	87
Figure 19 – Test circuit for the verification of the influence of surges in the main circuit (line-to-earth) – Three-phase poles in series configuration .....	88
Figure 20 – Test circuit for the verification of the influence of current surges in the main circuit – Three-phase poles in series configuration .....	89
Figure 21 – Test circuit for the verification of the influence of surges in the main circuit (line to earth) – Three-phase configuration.....	90
Figure 22 – Test circuit for the verification of the influence of current surges in the main circuit – Three-phase configuration .....	91
Figure 23 – Representation of test current produced by back-to-back thyristors.....	92
Figure 24 – Test current for the verification of the influence of the current dips and interruptions .....	93
Figure 25 – Radiated emission test set-up .....	94
Figure 26 – Thermal memory test.....	94
Figure F.1 – Over-current coordination between a CPS and a fuse or back-up protection by a fuse: operating characteristics .....	110
Figure F.2 – Total discrimination between CPSs and circuit-breakers – Case 1 .....	111
Figure F.3 – Total discrimination between CPSs and circuit-breakers – Case 2 .....	111

Figure F.4 – Back-up protection by a CPS/circuit-breaker – Operating characteristics – Case 1 .....	112
Figure F.5 – Back-up protection by a CPS/circuit-breaker – Operating characteristics Case 2 .....	112
Figure F.6 – Example of test circuit for conditional short-circuit breaking capacity tests showing cable connections for a 3-pole CPS ( $C_1$ ) .....	113
Figure H.1 – Test circuit for the verification of the operating characteristic of a residual current electronic overload relay .....	120
Table 1 – Utilization categories .....	17
Table 2 – Limits of operation of inverse time-delay overload relays or releases when energized on all poles .....	27
Table 3 – Trip classes of overload relays or releases for utilization categories AC-42, AC-43, AC-44, DC-43, DC-45 .....	27
Table 4 – Limits of operation of inverse time-delay overload relays or releases when energized on two poles only .....	28
Table 5 – Temperature rise limits of terminals .....	30
Table 6 – Temperature-rise limits of accessible parts .....	30
Table 7 – Temperature-rise limits for insulated coils in air .....	31
Table 8 – Intermittent duty test cycle data .....	32
Table 9 – Rated making and breaking capacities – Making and breaking conditions corresponding to the utilization categories .....	33
Table 10 – Relationship between current broken $I_C$ and OFF time for the verification of rated making and breaking capacities .....	34
Table 11 – Conventional operational performance after making/breaking capacity tests .....	35
Table 12 – Operational performance before and after short-circuit tests at $I_{Cr}$ and $I_{CS}$ .....	36
Table 13 – Prospective conventional test current $I_{Cr}$ and "r" current ( $I_r$ ) as a function of the maximum $I_e$ for a given construction .....	37
Table 14 – Acceptance criteria when EM disturbances are present .....	38
Table 15 – Test parameters for current dips and interruptions .....	56
Table 16 – Test sequences .....	58
Table G.1 – Individual pole .....	114
Table H.1 – Operating time of residual current electronic overload relays .....	117

## INTRODUCTION

The provisions of the General Rules are applicable to this part of IEC 60947-6, where specifically called for. General Rules clauses and subclauses thus applicable as well as tables, figures and appendices are identified by reference to Part 1 of IEC 60947-1, for example, 1.2.3, table 4, or annex A of Part 1.

<http://www.china-gauges.com/>

## LOW-VOLTAGE SWITCHGEAR AND CONTROLGEAR –

### Part 6-2: Multiple function equipment – Control and protective switching devices (or equipment) (CPS)

#### 1 Scope and object

This part of IEC 60947 applies to control and protective switching devices (or equipment) (CPS), the main contacts of which are intended to be connected to circuits of rated voltage not exceeding 1 000 V a.c. or 1 500 V d.c.

CPSs are intended to provide both protective and control functions for circuits and are operated otherwise than by hand. They may also fulfill additional functions, such as isolation.

**A1** Digital inputs and/or digital outputs contained in CPSs, and intended to be compatible with PLCs are covered by IEC 61131-2. **A1**

The object of this part is to state:

- the characteristics of CPS's;
- the conditions with which CPS's shall comply with reference to their operation and behaviour, their dielectric properties, the degree of protection provided by their enclosure where applicable;
- the tests intended to verify that these conditions have been met, and the methods to be adopted for these tests;
- the information to be marked on or given with the CPS's.

#### 2 Normative references

The following referenced documents are indispensable for the application of this document. For dated references, only the edition cited applies. For undated references, the latest edition of the referenced document (including any amendments) applies.

**A1** EC 60034-1:2004, *Rotating electrical machines – Part 1: Rating and performance*

IEC 60085:2004, *Electrical insulation – Thermal classification* **A1**

IEC 60410:1973, *Sampling plans and procedures for inspection by attributes*

IEC 60695-2-10:2000, *Fire hazard testing – Part 2-10: Glowing/hot-wire based test methods –Glow-wire apparatus and common test procedure*

IEC 60695-2-11:2000, *Fire hazard testing – Part 2-11: Glowing/hot-wire based test methods –Glow-wire flammability test method for end-products*

IEC 60695-2-12:2000, *Fire hazard testing – Part 2-12: Glowing/hot-wire based test methods –Glow-wire flammability test method for materials*

IEC 60695-2-13:2000, *Fire hazard testing – Part 2-13: Glowing/hot-wire based test methods – Glow-wire ignitability test method for materials*

<sup>A1</sup> IEC 60695-11-10:1999, *Fire hazard testing – Part 11-10: Test flames – 50 W horizontal and vertical flame test methods*  
Amendment 1 (2003)

IEC 60947-1:2004, *Low-voltage switchgear and controlgear – Part 1: General rules* <sup>A1</sup>

IEC 60947-6-1:1998, *Low-voltage switchgear and controlgear – Part 6-1: Multiple function equipment – Automatic transfer switching equipment*  
Amendment 1 (1994)  
Amendment 2 (1997)

<sup>A1</sup> IEC 60947-2:2006, *Low-voltage switchgear and controlgear – Part 2: Circuit-breakers* <sup>A1</sup>

IEC 61000-4-2:1995, *Electromagnetic compatibility (EMC) – Part 4: Testing and measurement techniques – Section 2: Electrostatic discharge immunity test – Basic EMC publication*  
Amendment 1 (1998)  
Amendment 2 (2000)

<sup>A1</sup> IEC 61000-4-3:2006, *Electromagnetic compatibility (EMC) – Part 4-3: Testing and measurement techniques – Radiated radio-frequency electromagnetic field immunity test*

IEC 61000-4-4:2004, *Electromagnetic compatibility (EMC) – Part 4-4: Testing and measurement techniques – Electrical fast transient/burst immunity test* <sup>A1</sup>

IEC 61000-4-5:1995, *Electromagnetic compatibility (EMC) – Part 4: Testing and measurement techniques – Section 5: Surge immunity tests*  
Amendment 1 (2000)

<sup>A1</sup> IEC 61000-4-6:2003, *Electromagnetic compatibility (EMC) – Part 4-6: Testing and measurement techniques – Immunity to conducted disturbances, induced by radio-frequency fields*  
Amendment 1 (2004)  
Amendment 2 (2006)

IEC 61131-2:2003, *Programmable controllers – Part 2: Equipment requirements and tests*

CISPR 11:2003, *Industrial, scientific and medical (ISM) radio-frequency equipment – Electromagnetic disturbance characteristics – Limits and methods of measurement*  
Amendment 1 (2004)  
Amendment 2 (2006) <sup>A1</sup>

### 3 Definitions

Clause 2 of Part 1 applies with the following additional definitions:

#### 3.1 Control and protective switching device (or equipment) (CPS)

switching device (or equipment) capable of operation other than by hand, but with or without local manual operating means

NOTE 1 The term "capable of operation other than by hand" means that the device is intended to be controlled and kept in working position from one or more external supplies.

**A1** NOTE 2 For CPSs controlled with an electromagnet, such an electromagnet may be electronically controlled (see 3.1.1). **A1**

A CPS is capable of making, carrying and breaking currents under normal conditions, including specified operating overload conditions and of making, carrying for a specified time and breaking currents under specified abnormal conditions such as those of short-circuits.

A CPS has overload and short-circuit protection, these functions being associated and coordinated so as to permit continuity of service at all currents up to its rated service short-circuit breaking capacity  $I_{CS}$ . A CPS may or may not consist of a single device but is always rated as a unit. Coordination may be either inherent or obtained by correct selection of releases in accordance with the manufacturer's instructions.

**A1** NOTE 3 **A1** A CPS may have more than one position of rest.

**A1** NOTE 4 **A1** In the context of this standard, the term "manufacturer" means any person, company or organization with ultimate responsibility as follows:

- to verify compliance with this standard;
- to provide the product information according to clause 6 (marking, identification, characteristics).

**A1** NOTE 5 **A1** In the context of this standard "continuity of service" means that CPS can be returned to service after occurrence of an over-current under the conditions specified of this part.

### **A1** 3.1.1

#### **electronically controlled coil for electromagnet**

coil controlled by a circuit with active electronic elements **A1**

### **3.2 CPS suitable for isolation**

CPS which in the open position complies with the requirements specified for the isolating function (see 8.1.6)

### **3.3 CPS for motor control and protection**

#### **3.3.1 Direct-on-line CPS**

CPS which connects the line voltage across the motor terminals in one step

#### **3.3.2 Reversing CPS**

CPS for starting a motor, intended to cause a motor to reverse the direction of rotation by reversing the motor primary connections while the motor may be running

#### **3.3.3 Two-direction CPS**

CPS for starting a motor, intended to cause a motor to reverse the direction of rotation by reversing the motor primary connections only when the motor is not running

### **3.4 Opening time**

Subclause 2.5.39 of Part 1 applies, with the following additions:

- in the case of a CPS tripped by an over-current relay or release, the instant of initiation of the opening time is the instant when the current reaches a value large enough to cause the CPS to operate;

- in the case of a CPS operated by any form of auxiliary power, the instant of initiation of the opening time is the instant of application of the auxiliary power to or its removal from the opening release.

NOTE For CPS's "opening time" is commonly referred to as "tripping time", although strictly speaking, tripping time applies to the time between the instant of initiation of the opening time and the instant when the opening command becomes irreversible.

### 3.5 Phase loss sensitive relay or release (for motor protection)

multipole relay or release for motor protection which operates in case of loss of phase in accordance with specified requirements

### **A1** 3.6

#### **under-current relay or release**

relay or release which operates automatically when the current through it is reduced below a predetermined value

### 3.7

#### **under-voltage relay or release**

relay or release which operates automatically when the voltage applied to it is reduced below a predetermined value

### 3.8

#### **stall sensitive electronic overload relay or release**

electronic overload relay or release which operates when the current has not decreased below a predetermined value for a specific period of time during start-up or when the relay receives the input indicating there is no rotation of the motor after a predetermined time in accordance with specified requirements

NOTE Explanation of stall: rotor locked during start.

### 3.9

#### **jam sensitive electronic overload relay or release**

electronic overload relay or release which operates in the case of overload and also when the current has increased above a predetermined value for a specific period of time during run in accordance with specified requirements

NOTE Explanation of jam: high overload occurring after the completion of starting which causes the current to reach the locked rotor current value of the motor being controlled.

### 3.10

#### **inhibit time**

time-delay period during which the tripping function of the relay is inhibited (may be adjustable)

### 3.11

#### **$I^2t$ characteristic of a SCPD**

information (usually a curve) giving the maximum values of  $I^2t$  related to break time as a function of prospective current (r.m.s. symmetrical for a.c.) up to the maximum prospective current corresponding to the rated short-circuit breaking capacity and associated voltage **A1**

## 4 Classification

Data which may be used as criteria for classification are given in 5.2.

## 5 Characteristics

### 5.1 Summary of characteristics

The characteristics of a CPS shall be stated in terms of the following, as applicable:

- type of CPS (5.2);
- rated and limiting values of the main circuit (5.3);
- utilization categories (5.4);
- control circuits (5.5);
- auxiliary circuits (5.6);
- relays and releases (5.7).

A1 Text deleted A1

### 5.2 Type of CPS

The following shall be stated:

#### 5.2.1 Number of poles

#### 5.2.2 Kind of current (a.c. or d.c.)

#### 5.2.3 Method of operation

For example:

- electromagnetic, manual, motor operated.

#### 5.2.4 Method of control

For example:

- automatic (by pilot switch or sequence control);
- non automatic (such as by handle or by push-buttons).

#### 5.2.5 Method of resetting after overload

The following types are recognized:

- self resetting;
- local manual resetting;
- remote resetting.

#### 5.2.6 Method of rearming after short-circuit

The following types are recognized:

- CPS capable of remote re-arming after operation;
- CPS incapable of remote re-arming after operation:
  - Those not requiring replacement of a renewable short-circuit protective element, for example a normally operated circuit-breaker.
  - Those requiring replacement of a renewable short-circuit protective element, for example a fuse-link.



### 5.3 Rated and limiting values of the main circuit

These values shall be stated in accordance with 5.3.1 to 5.3.6 but it may not be necessary to establish all the values listed.

#### 5.3.1 Rated voltages

**[A1]** Subclause 4.3.1 of IEC 60947-1 applies with the following addition.

CPSs for unearthed or impedance earthed systems (IT) require additional tests according to Annex G. **[A1]**

#### 5.3.2 Currents and powers

A CPS is defined by the following currents and powers:

- conventional free air thermal current ( $I_{th}$ ): 4.3.2.1 of Part 1 applies;
- conventional enclosed thermal current ( $I_{the}$ ): 4.3.2.2 of Part 1 applies;
- rated operational currents ( $I_e$ ) or, if applicable, rated operational powers): 4.3.2.3 of Part 1 applies.

#### 5.3.3 Rated frequency

Subclause 4.3.3 of Part 1 applies.

#### 5.3.4 Rated duties

Subclause 4.3.4 of Part 1 applies with the following addition to 4.3.4.3 of Part 1 (intermittent periodic duty or intermittent duty): In case of utilization categories AC-42 and AC-43, an operating cycle comprises starting, running to full speed and switching off the supply to the motor.

NOTE In the case of a CPS controlling a motor for intermittent duty, the difference between the thermal time-constant of the overload relay and that of the motor may render a thermal relay unsuitable for overload protection. It is recommended that, in this case, the question of overload protection be subject to an agreement between manufacturer and user.

#### 5.3.5 Normal load and overload characteristics

##### 5.3.5.1 Rated making and breaking capacities

Subclauses 4.3.5.2 and 4.3.5.3 of Part 1 apply with the following additions:

Requirements for the various utilization categories (5.4) are given in 8.2.4.1.

The rated making and breaking capacities are only valid when the CPS is operated in accordance with the requirements of 8.2.1.1 and 8.2.1.2.

### 5.3.6 Short circuit characteristics

#### 5.3.6.1 Rated service short-circuit breaking capacity ( $I_{CS}$ )

Subclause 4.3.6.3 of Part 1 applies with the following additions:

A rated short-circuit breaking capacity requires that the CPS shall be able to break any value of short-circuit current up to and including the value corresponding to the rated capacity at a power-frequency recovery voltage corresponding to the prescribed test voltage values and,

- for a.c., at any power-factor not less than that of table 16 of Part 1;
- for d.c., with a time constant up to that of table 16 of Part 1.

The rated service short-circuit breaking capacity of a CPS is the value of service short-circuit breaking capacity assigned to that CPS by the manufacturer for the corresponding rated operational voltage, under the conditions specified in 9.4.4.2. It is expressed as a value of prospective breaking current.  $I_{CS}$  shall be equal to or greater than  $I_{CR}$  (see 8.2.5a).

NOTE For a.c., the short-circuit making capacity of a CPS shall be not less than its rated service short-circuit breaking capacity, multiplied by the factor  $n$  of table 16 of Part 1.

For d.c., the short-circuit making capacity of a CPS shall be not less than its rated service short-circuit breaking capacity.

### 5.4 Utilization categories

Subclause 4.4 of Part 1 applies with the following additions:

#### 5.4.1 Standard utilization categories

Utilization categories given in table 1 are considered as standard. Any other type of utilization shall be based on an agreement between manufacturer and user, but information given in the manufacturer's catalogue or a tender may constitute such an agreement.

Each utilization category is characterized by the values of currents (including prospective conventional test current, see 8.2.5a), voltages, power factors, or time constants and other data in tables 9, 10, 11, 12 and 13 and by the test conditions specified in this standard.

For CPS's defined by their utilization categories, it is therefore unnecessary to specify separately the rated making and breaking capacities as these values depend directly on the utilization category as shown in table 9.

The voltage for all utilization categories is the rated operational voltage of the CPS.

Table 1 – Utilization categories

Utilization categories*	Typical application
AC-40	Distribution circuits comprising mixed resistive and reactive loads having a resultant inductive reactance
AC-41	Non-inductive or slightly inductive loads, resistance furnaces
AC-42	Slip-ring motors: starting, switching off
AC-43	Squirrel-cage motors: starting, switching off, motors during running <sup>1)</sup>
AC-44	Squirrel-cage motors: starting, plugging, inching
AC-45a	Switching of electric discharge lamp controls
AC-45b	Switching of incandescent lamps
DC-40	Distribution circuits comprising mixed resistive and ractive loads having a resultant inductive reactance
DC-41	Non-inductive or slightly inductive loads, resistance furnaces
DC-43	Shunt-motors: starting, plugging, inching. Dynamic breaking of d.c. motors
DC-45	Series-motors: starting, plugging, inching. Dynamic breaking of d.c. motors
DC-46	Switching of incandescent lamps

<sup>1)</sup> AC-43 category may be used for occasional inching (jogging) or plugging for limited time periods such as machine set up; during such limited time periods the number of operations should not exceed five per minute nor 10 in a 10-min period.

\* The first digit designates a CPS.  
The second digit designates a typical application.

#### 5.4.2 Assignment of utilization categories based on the results of tests

- a) A CPS which has been tested for one utilization category or at any combination of parameters (such as highest operational voltage and current, etc.) can be assigned other utilization categories without additional testing provided that the values of test current, voltages, power-factors or time-constants, number of operating cycles, the on and off times and the test circuit for the assigned utilization categories are not more severe than those at which the equipment has been tested and temperature rise has been verified at a current in continuous duty.

For example, when tested for utilization category AC-44, a CPS may be assigned utilization category AC-43 provided that  $I_e$  for AC-43 is not higher than 1,2 times  $I_e$  for AC-44 at the same rated operational voltage.

- b) DC-43 or DC-45 CPS is assumed to be capable of opening and closing loads other than those on which they have been tested provided that:
- the voltage and current do not exceed the specified values of  $U_e$  and  $I_e$ ;
  - the energy  $J$  stored in the actual load is equal to or less than the energy  $J_c$  stored in the load with which the CPS has been tested.

The values of the energy stored in the test circuit are as follows:

Utilization category	Stored energy $J_c$
DC-43	$0,00525 \times U_e \times I_e$
DC-45	$0,0315 \times U_e \times I_e$

The values of the constants 0,00525 and 0,0315 are derived from:  $I_c = 1/2 LI^2$  where the time constant has been replaced by  $2,5 \times 10^{-3}$  s for DC-43 and  $15 \times 10^{-3}$  s for DC-45 and where  $U = 1,05 U_e$  and  $I = 4 I_e$  (see table 9).

### 5.4.3 Application of utilization categories for motor control duty

Typical service conditions are:

- rotation in one direction, the motor being switched off while running under normal service conditions (utilization categories AC-42, AC-43);
- rotation in two directions, but running of the motor in the second direction being started only after the CPS has been switched off and the motor completely stopped (utilization categories AC-42, AC-43);
- rotation in one direction, or in two directions as in the previous paragraph, but with the possibility of infrequent inching. For this service condition, a direct-on-line CPS is generally used (utilization category AC-43);
- rotation in one direction with frequent inching (jogging); a direct-on-line CPS is generally used (utilization category AC-44);
- rotation in one or two directions but with the possibility of infrequent plugging in order to stop the motor, the plugging being associated with rotor resistor braking if this is provided. In this case a CPS may be used in the stator circuit (utilization category AC-42);
- rotation in two direction but with the possibility of reversing the supply connections to the motor while it is running in the first direction (plugging), in order to obtain its rotation in the other direction while switching off the motor running under normal service conditions. A direct-on-line reversing CPS is generally used for this service condition (utilization category AC-44).

Unless otherwise stated CPS's used as starters are designed on the basis of the starting characteristics of the motors compatible with the making capacities of table 9. When the starting current of a motor exceeds these values, a CPS having a suitably higher rated operational current should be used.

### 5.5 Control circuits

**[A1]** Subclause 4.5 of IEC 60947-1 applies; moreover, for an electronically controlled electro-magnet, Subclause 4.5.1 of IEC 60947-1 applies with the following addition.

The electronic part may form an integral part or a separate part provided it is an intrinsic function of the device. In both cases, the device shall be tested with this electronic part mounted and installed as in normal use. **[A1]**

**A1** The characteristics of electronic control circuits are as follows:

- type of current;
- power consumption;
- rated frequency (or d.c.);
- rated control circuit voltage,  $U_c$  (nature: a.c./d.c.);
- rated control supply voltage,  $U_s$  (nature: a.c./d.c.);
- nature of external control circuit devices (contacts, sensors, optocouplers, electronic active components, etc.).

Annex E gives examples and illustrations of different circuit configurations.

NOTE A distinction is made between the control circuit voltage  $U_c$ , which is the controlling input signal, and the control supply voltage  $U_s$ , which is the voltage applied to energize the power supply terminals of the control circuit equipment and may be different from  $U_c$  due to the presence of built-in transformers, rectifiers, resistors, electronic circuitry, etc. **A1**

## 5.6 Auxiliary circuits

Subclause 4.6 of Part 1 applies.

## 5.7 Relays or releases

Subclause 4.7 of Part 1 applies with the following additions:

### 5.7.1 Types of relays or releases

**5.7.1.1 Shunt release** (2.4.33 of Part 1)

**5.7.1.2 Under-voltage and under-current relay or release (for opening)** (2.4.34 of Part 1).

**5.7.1.3 Over-current relays or releases.**

#### **A1** 5.7.1.3.1 Overload relay or release

- a) Instantaneous overload relay or release (e.g. jam sensitive, see 3.9). **A1**
- b) Definite time delay overload relay or release (2.4.26 of Part 1).
- c) Inverse time delay overload relay or release (2.4.27 of Part 1):
  - i) **A1** substantially independent of previous load;
  - ii) dependent on previous load;
  - iii) dependent on previous load and also sensitive to phase loss (see 3.5).
- d) Stall relay or release (see 3.8). **A1**

#### **5.7.1.3.2 Short-circuit relays or releases:**

- a) Instantaneous short-circuit relay or release (2.4.24 of Part 1);
- b) Definite time delay short-circuit relay or release (2.4.26 of Part 1).

NOTE A CPS has a combination of relays or releases from 5.7.1.3.1 and 5.7.1.3.2 above.

**5.7.1.4 Other relays and releases** (e.g. phase failure relay, control relay associated with devices for motor thermal protection, residual current relay).

NOTE Types referred to under 5.7.1.4 require consultation between manufacturer and user according to the particular application.

### 5.7.2 Characteristic values

**A1** Shunt, under-voltage (under-current), over-voltage (instantaneous over current), current or voltage asymmetry and phase reversal opening relay or release:

- rated voltage (current);
- rated frequency;
- operating voltage (current);
- operating time (when applicable);
- inhibit time (when applicable).

*Over-current relay or release:*

- designation and current setting (or range of settings) (see 5.7.3);
- rated frequency, where necessary (e.g. in the case of a current transformer operated overload relay);
- time-current characteristics (or range of characteristics), where necessary;
- trip class, where applicable according to classification in Table 3, or the value of the maximum tripping time, in seconds, under the conditions specified in 8.2.1.5.1, Table 2, column *D*, when this time exceeds 40 s;
- nature of the relay or release: thermal, magnetic, electronic or electronic without thermal memory;
- nature of the reset: manual or automatic.

*Relay or release with residual current sensing:*

- rated current;
- operating current;
- operating time or time-current characteristic according to Table H.1;
- inhibit time (when applicable);
- type designation (see Annex H). **A1**

### 5.7.3 Designation and current setting of overload relays or releases

Overload relays or releases are designated by their current setting (or the upper and lower limits of current setting range, if adjustable) and their trip class, where applicable. The current setting (or current setting range) shall be marked on the relay or release.

### 5.7.4 Time current characteristics of over current relays or releases

*Time-delay relay or release:*

- Definite time delay: the time delay of such relays or releases is independent of the over-current. The tripping time setting shall be stated as the duration in seconds of the opening time of the CPS if the time delay is not adjustable, or the minimum and maximum values of the opening time, if the time delay is adjustable.

- Inverse time delay: the time-current characteristics shall be given in the form of curves supplied by the manufacturer. These shall indicate how the opening time, starting from the cold state, varies with current within the range of operation of the relay or release. The manufacturer shall indicate, by suitable means, the tolerances applicable to these curves. These curves shall be given for the minimum and maximum values of the current setting and, if the time setting for a given current setting is adjustable, it is recommended that they be given in addition for each minimum and maximum values of the time setting.

NOTE Note of 4.8 of Part 1 applies.

### 5.7.5 Influence of ambient air temperature

Unless otherwise specified, the operating value of over-current relays or releases other than those of the thermal type is independent of the ambient air temperature within the limits of  $-5\text{ }^{\circ}\text{C}$  to  $+40\text{ }^{\circ}\text{C}$ .

For relays or releases of the thermal type:

The time-current characteristics refer to a stated value of ambient air temperature and are based on no previous loading of the overload relay (i.e. from an initial cold state).

This value of the ambient air temperature shall be clearly given on the time curves; the preferred values are  $+20\text{ }^{\circ}\text{C}$  or  $+40\text{ }^{\circ}\text{C}$ .

The overload-relays or releases shall be able to operate within the ambient air temperature range of  $-5\text{ }^{\circ}\text{C}$  to  $+40\text{ }^{\circ}\text{C}$  and the manufacturer shall be prepared to state the effect of variation in ambient air temperature on the characteristics of overload relays or releases.

**A1** Subclause deleted **A1**

## 6 Product information

### 6.1 Nature of information

The following information shall be given by the manufacturer concerning:

#### 6.1.1 Identification

- a) The manufacturer's name or trademark.
- b) Type designation or serial number.
- c) Number of this part, if the manufacturer claims compliance.

#### 6.1.2 Characteristics

- d) **A1** Rated operational voltages  $U_e$  (see 5.3.1 and, where applicable, Annex G). **A1**
- e) Utilization category and rated operational currents (or, where applicable, rated powers) at the rated-operational voltages.
- f) Either the rated frequency (e.g.: 50 Hz, 50 Hz/60 Hz) and/or the indication "d.c." (or the symbol  $\text{—}=\text{—}$ ).
- g) Rated duty with the indication of the class of intermittent duty, if any.
- h) Rated service short-circuit breaking capacity ( $I_{cs}$ ) (see 5.3.6.1).
- i) Rated impulse withstand voltage ( $U_{imp}$ ).
- j) Indication of the open and closed positions (see 8.1.4 and 8.1.5).
- k) Pollution degree (see 7.1.3.2).

- l) Rated control circuit voltage ( $U_C$ ), nature of current and rated frequency (if a.c.).
- m)  $\square_{A1}$  Vacant.  $\square_{A1}$
- n) IP code, for enclosed CPS's.
- o) If necessary, nature of current, rated frequency and rated control supply voltage ( $U_S$ ).
- p) Ratings of auxiliary circuits.
- r)  $\square_{A1}$  Current setting and identification of time-current characteristic of over current relays or releases, specifying, according to 5.7, if the electronic overload relay does not contain thermal memory.  $\square_{A1}$
- s) Other characteristics of over-current relays or releases according to 5.7.
- t) In the case of renewable short-circuit protective elements (see 5.2) current rating, type and characteristics in accordance with relevant standard.
- u) Suitability for isolation where applicable (see 5.2 of Part 1).
- v) Environment A or environment B (see 7.3.1 of IEC 60947-1).
- w) Special requirements, if applicable, for example shielded or twisted conductors.

NOTE Unshielded or untwisted conductors are considered as normal installation conditions.

## 6.2 Marking

Sub-clause 5.2 of Part 1 applies with the following additions related to 6.1.1 and 6.1.2 above:

- Data a and b and relevant operational data under d, e, and f.
- Data a and b shall be marked on the CPS and preferably on the nameplate if any
- Data under c and n shall be preferably marked on the CPS
- Data under h and t and relevant operational data under d, e and f shall be marked on the CPS
- Data under r shall be marked on the relay or release
- Data under u shall be marked on the CPS, the global symbol being: 
- Any remaining data shall be marked on the CPS, or included in the manufacturer's published literature.
- Terminals shall be marked so as to clearly identify line and load terminals (see 8.1.7.4).

$\square_{A1}$  If the manufacturer declares an electronic overload relay without thermal memory, this shall be marked on the device.  $\square_{A1}$

## 6.3 Instructions for installation, operation and maintenance

$\square_{A1}$  Subclause 5.3 of IEC 60947-1 applies with the following addition:

The manufacturer of a CPS incorporating an automatic reset overload relay capable of being connected to enable automatic restarting shall provide, with the CPS, that information necessary to alert the user to the possibility of automatic restarting.  $\square_{A1}$

## 7 Normal service, mounting and transport conditions

Clause 6 of Part 1 applies with the following additions:



### 7.1.3.2 Degrees of pollution

Unless otherwise stated by the manufacturer's, a CPS is for use in pollution degree 3 environmental conditions, as defined in 6.1.3.2 of Part 1. However, other pollution degrees may be considered to apply depending upon the micro-environment.

## 8 Constructional and performance requirements

### 8.1 Constructional requirements

#### 8.1.1 Materials

<sup>A1</sup> Subclause 7.1.1 of IEC 60947-1 applies with the following additions.

The manufacturer shall specify which test method is to be used.

When tests on the equipment or on sections taken from the equipment are used, parts of insulating materials necessary to retain current-carrying parts in position shall conform to the glow-wire tests of 8.2.1.1.1 of IEC 60947-1 at a test temperature of 960 °C.

Parts of insulating materials other than those specified in the previous paragraph shall conform to the requirements of the glow-wire test of 8.2.1.1.1 of IEC 60947-1 at a temperature of 650 °C.

When tests on materials are used, they shall be made according to the tests for flammability category, hot wire ignition and, where applicable, arc ignition, as specified in 8.2.1.1.2 of IEC 60947-1. The material used shall comply with the values given in Table M.1 of IEC 60947-1 according to the manufacturer's chosen flammability category (see IEC 60695-11-10). <sup>A1</sup>

#### 8.1.2 Current-carrying parts and their connections

Subclause 7.1.2 of IEC 60947-1 applies.

#### 8.1.3 Clearances and creepage distances

Subclause 7.1.3 of Part 1 applies.

#### 8.1.4 Actuator

Subclause 7.1.4 of Part 1 applies.

#### 8.1.5 Indication of the contact position

Subclause 7.1.5 of Part 1 applies.

#### 8.1.6 Additional safety requirements for CPS's suitable for isolation

Subclause 7.1.6 of Part 1 applies with the following addition:

CPS's suitable for isolation shall be provided with means for locking in the isolated position.

<sup>A1</sup> Text deleted <sup>A1</sup>

### 8.1.7 Terminals

Subclause 7.1.7 of Part 1 applies with the following addition:

#### 8.1.7.4 Terminal identification and marking

Subclause 7.1.7.4 of Part 1 applies with additional requirements as given in annex C with the following addition:

Line and load terminals of CPS for utilization categories AC-40 and DC-40 having trip units which are not removable or sealed against removal may not be identified, in which case control circuits shall not be internally connected to the main circuit.

#### 8.1.8 Additional requirements for CPS's provided with a neutral pole

Subclause 7.1.8 of Part 1 applies.

#### 8.1.9 Provisions for protective earthing

Subclause 7.1.9.1 of Part 1 applies.

#### 8.1.10 Enclosures for CPS's

Subclause 7.1.10 of Part 1 applies with the following addition:

In the case of enclosed CPS's provided with an externally manually operated actuator, the door or cover shall be interlocked so that they cannot be opened without the CPS being in the open position. However, provision may be made to open the door or cover with the CPS in the ON position by the use of a tool.

## 8.2 Performance requirements

### 8.2.1 Operating conditions

#### 8.2.1.1 General

Subclause 7.2.1.1 of Part 1 applies with the following additions:

CPS's shall be so constructed that they are trip free (see 2.4.23 of Part 1).

CPS's shall not trip due to the shock caused by their operation when tested according to 9.3.3.1 after having carried their maximum rated operational current at the reference ambient air temperature and reached thermal equilibrium at both minimum and maximum settings of the overload relay if adjustable.

Resetting of relays and releases shall not result in a closing operation of the CPS in the absence of a closing command.

#### 8.2.1.2 Limits of operation of power operated CPS's

##### **A1** 8.2.1.2.1 CPSs controlled with an electromagnet

CPSs controlled with an electromagnet shall close satisfactorily at any value between 85 % and 110 % of their rated control supply voltage  $U_c$ . Where a range is declared, 85 % shall apply to the lower value and 110 % to the higher. **A1**

**A1)** The limits between which CPSs shall drop out and open fully are 75 % to 20 % for a.c. and 75 % to 10 % for d.c. of their rated control supply voltage  $U_s$ . Where a range is declared, 20 % or 10 %, as the case may be, shall apply to the higher value and 75 % to the lower value.

Limits for closing are applicable after the coils have reached a stable temperature corresponding to indefinite application of 100 %  $U_s$  in an ambient temperature equivalent to the ambient temperature declared by the manufacturer but not less than +40 °C.

Limits for drop-out are applicable with the coil circuit resistance at -5 °C. This can be verified by calculation using values obtained at normal ambient air temperature.

The limits apply to d.c. and a.c. at declared frequency.

#### **8.2.1.2.2 CPSs with electronically controlled electromagnet**

Subclause 8.2.1.2.1 applies with the following modification.

Replace the second paragraph as follows:

The limits between which CPSs with an electronically controlled electromagnet shall drop out and open fully are as follows:

- for d.c.: 75 % to 10 % of their rated control supply voltage  $U_s$ ,
- for a.c.: 75 % to 20 % of their rated control supply voltage  $U_s$ ,
- for a.c.: 75 % to 10 % of their rated control supply voltage  $U_s$  if specified by the manufacturer,
- for a.c., where a range is declared with limits between 75 % to 10 % of their rated control supply voltage  $U_s$ , the CPS shall, in addition, be submitted to the capacitive drop out test of 8.2.1.2.4.

Where a range is declared, 20 % or 10 % as the case may be shall apply to the higher value of the range and 75 % to the lower value of the range.

#### **8.2.1.2.3 CPSs operated electro-pneumatically**

CPSs operated electro-pneumatically or pneumatically shall close satisfactorily with the air supply pressure between 85 % and 110 % of the rated pressure and open between 75 % and 10 % of the rated pressure.

#### **8.2.1.2.4 Capacitive drop out test**

A capacitor C shall be inserted in series in the supply circuit  $U_s$ , the total length of the connecting conductors being  $\leq 3$  m. The capacitor is short-circuited by a switch of negligible impedance. The supply voltage shall then be adjusted to 110 %  $U_s$ .

It shall be verified that the CPS drops out when the switch is operated to the open position.

The value of the capacitor shall be as follows:

$$C \text{ (nF)} = 30 + 200\,000 / (f \times U_s \text{ max})$$

e.g. for a coil rated 12...24 V – 50 Hz, the capacitor value is 196 nF (calculation made with  $U_s$  max., see note 1).

NOTE 1 The test voltage is the highest value of the declared rated supply voltage range  $U_s$ . **A1)**

**A1**) NOTE 2 The value of the capacitor is calculated in order to simulate a 100 m long cable of 1,5 mm<sup>2</sup> connected to a static output having a 1,3 mA leakage current.

NOTE 3 The drop out time should be specified for particular uses, e.g. emergency breaking.

### 8.2.1.5 Limits of operation of current sensing relays and releases

#### 8.2.1.5.1 Opening under overload conditions

##### 8.2.1.5.1.1 General tripping requirements of inverse time-delay overload relays or releases (type c) in 5.7.1.3.1)

###### i) Utilization categories AC-42, AC-43, AC-44, DC-43, DC-45

NOTE 1 The thermal protection of motors in the presence of harmonics in the supply voltage is under consideration.

*When all poles are energized*

The relays or releases are classified for these utilization categories according to Table 3 and shall comply with the requirements of Tables 2 and 3 when tested as follows:

- With the CPS in its enclosure, if normally fitted, and at *A* times the current setting, tripping shall not occur in less than 2 h starting from the cold state, at the value of reference ambient air temperature stated in Table 2. However, when the overload relay terminals have reached thermal equilibrium at the test current in less than 2 h, the test duration can be the time to reach such thermal equilibrium.
- When the current is subsequently raised to *B* times the current setting, tripping shall occur in less than 2 h.
- For trip classes 2, 3, 5 and 10A overload relays or releases energized at *C* times the current setting, tripping shall occur in less than 2 min, starting from thermal equilibrium at 1,0 times the current setting, in accordance with 9.3.3 of IEC 60034-1.

NOTE 2 Subclause 9.3.3 of IEC 60034-1 states: "Polyphase motors having rated outputs not exceeding 315 kW and rated voltages not exceeding 1 kV shall be capable of withstanding a current equal to 1,5 times the rated current for not less than 2 min."

- For trip classes 10, 20, 30 and 40 overload relays or releases energized at *C* times the current setting, tripping shall occur in less than 4 min, 8 min, 12 min or 16 min respectively, starting from thermal equilibrium at 1,0 times the current setting.
- At *D* times the current setting, tripping time  $T_p$  shall occur within the limits given in Table 3 for the appropriate trip class and tolerance band starting from the cold state.
- In the case of overload relays or releases having a current setting range, the limits of operation shall apply both when the relay or release is carrying the current associated with the maximum setting and when the relay or release is carrying the current associated with the minimum setting.
- For non-compensated overload relays or releases the current multiple/ambient temperature characteristic shall be not greater than 1,2 %/K.

NOTE 3 1,2 %/K is the derating characteristic of PVC insulated cables.

An overload relay or release is regarded as compensated if it complies with the relevant requirements of Table 2 at 20 °C and is within the limits shown in Figure 1 at other temperatures. **A1**

**Table 2 – Limits of operation of inverse time-delay overload relays or releases when energized on all poles**

Utilization category	Type of relay or release	Multiples of current setting				Ambient air temperature values
		A	B	C	D	
AC-42	Thermal type not compensated for ambient air temperature variations	1,0	1,2	1,5	7,2	-5 °C, +20 °C and +40 °C
AC-43	Thermal type compensated for ambient air temperature variations	1,05	1,3	1,5	-	-5 °C
AC-44		1,05	1,2	1,5	7,2	+20 °C
DC-43		1,0	1,2	1,5	-	+40 °C
DC-45	Electronic type	1,05	1,2	1,5	7,2	-5 °C, +20 °C and +40 °C
AC-40 AC-41 AC-45a AC-45b DC-40 DC-41 DC-46	All types	1,05	1,3	-	-	+30 °C

**Table 3 – Trip classes of overload relays or releases for utilization categories AC-42, AC-43, AC-44, DC-43, DC-45**

Trip class	Tripping time $T_p$ under the conditions specified in 8.2.1.5.1.1, Table 2, column D <sup>a</sup>	Tripping time $T_p$ under the conditions specified in 8.2.1.5.1.1, Table 2, column D for tighter tolerances (tolerance band E) <sup>a</sup>
	s	s
2	-	$T_p \leq 2$
3	-	$2 < T_p \leq 3$
5	$0,5 < T_p \leq 5$	$3 < T_p \leq 5$
10A	$2 < T_p \leq 10$	-
10	$4 < T_p \leq 10$	$5 < T_p \leq 10$
20	$6 < T_p \leq 20$	$10 < T_p \leq 20$
30	$9 < T_p \leq 30$	$20 < T_p \leq 30$
40	-	$30 < T_p \leq 40$

<sup>a</sup> The manufacturer shall add the letter E to trip classes to indicate compliance with the band E.

*When two poles are energized*

With reference to Table 4, with the relay or release energized on three poles, at A times the current setting, tripping shall not occur in less than 2 h, starting from the cold state, at the value of the ambient air temperature stated in Table 4. **A1**

**A1)** Moreover, when the value of the current flowing in two poles (in phase-loss sensitive relays those carrying the higher current) is subsequently increased to  $B$  times the current setting, and the third pole de-energized, tripping shall occur in less than 2 h.

The values shall apply to all combinations of poles.

In the case of relays or releases having an adjustable current setting the characteristics shall apply both when the relay or release is carrying the current associated with the maximum setting, and when the relay is carrying the current associated with the minimum setting.

**Table 4 – Limits of operation of three-pole inverse time-delay overload relays or releases when energized on two poles only**

Type of overload relay or release	Multiples of current setting		Reference ambient air temperature
	A	B	
Thermal, compensated for ambient air temperature variations or electronic Not phase-loss sensitive	3 poles 1,0	2 poles 1,32  1 pole 0	+20 °C
Thermal, not compensated for ambient air temperature variations Not phase-loss sensitive	3 poles 1,0	2 poles 1,25  1 pole 0	+40 °C
Thermal, compensated for ambient air temperature variations or electronic Phase-loss sensitive	2 poles 1,0  1 pole 0,9	2 poles 1,15  1 pole 0	+20 °C

ii) *Utilization categories AC-40, AC-41, AC-45a, AC-45b; DC-40, DC-41, DC-46*

Conventional values for inverse time-delay overload relays or releases operation are given in Table 2.

At the reference temperature of  $30\text{ °C} \pm 2\text{ °C}$  and at 1,05 times the current setting, i.e. with the conventional non-tripping current (see 2.5.30 of IEC 60947-1), the opening release being energized on all poles, tripping shall not occur in less than the conventional time 2 h (1 h when  $I_e < 63\text{ A}$ ) from the cold state i.e. with the CPS at the reference temperature.

Moreover, when at the end of the conventional time the value of current is immediately raised to 1,30 times the current setting, i.e. with the conventional tripping current (see 2.5.31 of IEC 60947-1), tripping shall occur in less than the conventional time above.

NOTE 4 The reference temperature is the ambient air temperature on which the time/current characteristic of the CPS is based.

If a relay or release is declared by the manufacturer as substantially independent of ambient temperature, the current values of Table 2 shall apply within the temperature band declared by the manufacturer, within a tolerance of 0,3 % per K. The width of the temperature band shall be at least  $\pm 10\text{ K}$  from the reference temperature. **A1)**

**Ⓐ) 8.2.1.5.1.2 Thermal memory test verification for utilization categories AC-42, AC-43, AC-44, DC-43, DC-45**

Unless the manufacturer has specified that the device does not contain thermal memory, electronic overload relays shall fulfil the following requirements (see Figure 25).

- apply a current equal to  $I_e$  until the device has reached the thermal equilibrium;
- interrupt the current for a duration of  $2 \times T_p$  (see Table 3) with a relative tolerance of  $\pm 10\%$  (where  $T_p$  is the time measured at current  $I$  according to Table 2);
- apply a current equal to  $7,2 \times I_e$ ;
- the relay shall trip within 50 % of time  $T_p$ .

**8.2.1.5.1.3 Opening under overload conditions of instantaneous and definite time-delay overload relays or releases (types a) and b) in 5.7.1.3.1)**

For all values of the current setting, the CPS shall trip with an accuracy of  $\pm 10\%$  of the specified tripping current value corresponding to the current setting.

**8.2.1.5.2 Opening under short-circuit conditions**

*Instantaneous and definite time-delay short-circuit relays or releases (items a) and b) of 5.7.1.3.2).*

For all values of the current setting, the CPS shall trip with an accuracy of  $\pm 20\%$  of the published tripping current value corresponding to the current setting.

**8.2.1.5.3 Limits of operation of under-current relays or releases for automatic change-over**

An under-current relay or release shall operate to open the CPS within 90 % to 110 % of the set time when the current during run is below 0,9 times the under-current setting in all poles.

**8.2.1.5.4 Limits of operation of stall relays or releases**

A stall relay or release shall operate to open the CPS within 80 % to 120 % of the set time (stall inhibit time) or within the accuracy specified by the manufacturer, in the following cases:

- a) current sensing relays: the current is 20 % higher than the set stall current value;

EXAMPLE: Set current of the stall relay: 100 A; set time: 6 s; accuracy:  $\pm 10\%$ , the relay shall trip within 5,4 s and 6,6 s when the current is equal to or greater than  $100 \text{ A} \times 1,2 = 120 \text{ A}$ .

- b) rotation sensing relays: an input signal indicating no motor rotation exists.

**8.2.1.5.5 Limits of operation of jam relays or releases**

A jam relay or release shall operate to open the CPS within 80 % to 120 % of the set time (jam inhibit time) or within the accuracy specified by the manufacturer, when the current is above 1,2 times the set current value of the jam relay, during running after completion of the starting. **Ⓐ)**

### 8.2.2 Temperature rise

**A1)** Subclause 7.2.2 of IEC 60947-1 applies to CPSs in a clean, new condition. In the case of conducting the test at a voltage below 100 V, such devices may have the contacts cleaned by any nonabrasive method or cycled with or without load several times prior to initiating the test.

NOTE Contact resistance due to oxidation is not considered to impact the temperature rise test at test voltages above 100 V.

In the case of an electronically controlled solenoid magnet, coil temperature measuring by variation of resistance may be impractical; in such a case, other methods are permitted, e.g. thermocouples or other suitable methods. **A1)**

#### 8.2.2.1 Terminals

The temperature rise of terminals shall not exceed the values stated in table 5.

**Table 5 – Temperature rise limits of terminals**

Terminal material	Temperature-rise limits <sup>2)</sup> K
Bare copper	60
Bare brass	65
Tin plated copper or brass	65
Silver plated or nickel plated copper or brass	70 <sup>1)</sup>
Other metals	<sup>3)</sup>

1) The terminal temperature-rise limit of 70 K is based on the connection of PVC cables. The use in service of connected conductors or cables significantly smaller than those listed in table 9 and 10 of Part 1 could result in higher terminal and internal part temperatures and such conductors should not be used without the manufacturer's consent since higher temperatures could lead to equipment failure.

2) The specified temperature-rise limits apply to a new sample, as in test sequence I of 9.4.1. Those applicable to temperature-rise verifications, as in test sequence IV (9.4.4) are increased by 10 K.

3) Temperature rise limits to be based on service experience or life tests but not exceeding 65 K.

#### 8.2.2.2 Accessible parts

The temperature-rise of accessible parts shall not exceed the values stated in table 6.

**Table 6 – Temperature-rise limits of accessible parts**

Description of part <sup>1)</sup>	Temperature-rise limits <sup>2)</sup> K
Manual operating means:	
– metallic	15
– non-metallic	25
Parts intended to be touched but not hand held:	
– metallic	30
– non-metallic	40
Parts which need not be touched for normal operation:	
– metallic	40
– non-metallic	50

1) No value is specified for parts other than those listed but no damage shall be caused to adjacent parts of insulating materials.

2) The temperature-rise limits specified apply to a new sample.



### 8.2.2.3 Ambient air temperature

Subclause 7.2.2.3 of Part 1 applies.

### 8.2.2.4 Main circuit

Subclause 7.2.2.4 of Part 1 applies with the following addition:

The main circuit of a CPS, including the over current relays or releases, shall be capable of carrying the maximum rated operational current corresponding to the utilization category for uninterrupted, intermittent or temporary duty without the temperature-rise exceeding the limits specified in tables 5 and 6. An uninterrupted duty rating is required for utilization categories AC-40 and DC-40.

### 8.2.2.5 Control circuits

The control circuits, including control circuit devices to be used for the closing and opening operations of a CPS, shall permit the rated duty as specified in 5.3.4 and also the temperature-rise tests specified in 9.3.3.3.5 without the temperature-rise exceeding the limits specified in tables 5 and 6.

### 8.2.2.6 Windings of coils and electromagnets

#### 8.2.2.6.1 Uninterrupted and 8 h duty windings

With the maximum value of current flowing through the main circuit, the windings of the coils shall withstand under continuous load and at the rated frequency, if applicable, their rated control supply voltage without the temperature rise exceeding the limits specified in table 7.

<sup>A1</sup> NOTE Depending on the technology, e.g. for some kinds of electronically controlled electromagnets, the control supply voltage may not be directly applied on the coil winding when connected as in normal service. <sup>A1</sup>

#### 8.2.2.6.2 Intermittent duty windings

With no current flowing through the main circuit the windings of the coils shall withstand, at the rated frequency, if applicable, their rated control supply voltage (or the maximum rated control voltage in case of a range) applied as detailed in table 8 according to their intermittent duty class, without the temperature-rise exceeding the limits specified in table 7.

<sup>A1</sup> NOTE Depending on the technology, e.g. for some kind of electronically controlled electromagnet, the control supply voltage may not be directly applied on the coil winding when connected as in normal service. <sup>A1</sup>

**Table 7 – Temperature-rise limits for insulated coils in air**

Class of insulating material <sup>A1</sup> (according to IEC 60085) <sup>A1</sup>	Temperature-rise limit (measured by resistance variation) K
A	85
E	100
B	110
F	135
H	160

<sup>A1</sup> Note deleted <sup>A1</sup>

Table 8 – Intermittent duty test cycle data

Intermittent duty class of CPS	One close-open operating cycle every:	Interval of time during which the supply to the control CPS is maintained
1	3 600 s	"ON time" shall correspond to the on load factor specified by the manufacturer
3	1 200 s	
12	300 s	
30	120 s	
120	30 s	
300	12 s	
1 200	3 s	

**8.2.2.6.3 Specially rated (short-time or periodic duty) windings**

Specially rated windings shall be tested under operating conditions corresponding to the most severe duty for which they are intended and their ratings shall be stated by the manufacturer.

**8.2.2.7 Auxiliary circuits**

Subclause 7.2.2.7 of Part 1 applies.

**8.2.2.8 Other Parts**

Subclause 7.2.2.8 of Part 1 applies.

**8.2.3 Dielectric properties**

Subclause 7.2.3 of Part 1 applies.

**8.2.4 Performance under no load, normal load and overload conditions**

Unless otherwise specified all tests are made by energizing and de-energizing remotely the control function circuit.

**8.2.4.1 Making and breaking capacities**

CPS shall be capable of making and breaking currents without failure, under the conditions stated in table 9 for the required utilization categories.

The values of the OFF time and the ON time stated in tables 9 and 10 shall not be exceeded.

**Table 9 – Rated making and breaking capacities – Making and breaking conditions corresponding to the utilization categories**

Utilization category	Make and break conditions					
	$I_c/I_e$	$U_r/U_e$	$\text{Cos } \phi$	On time <sup>2)</sup> s	Off time s	Number of operating cycles
AC-40	6	1,05	0,5	0,05	5)	24
AC-41	1,5	1,05	0,8	0,05	5)	50
AC-42	4,0	1,05	0,55	0,05	5)	50
AC-43 <sup>7)</sup>	8,0	1,05	1)	0,05	5)	50
AC-44 <sup>7)</sup>	10,0	1,05	1)	0,05	5)	50
AC-45a	3,0	1,05	0,45	0,05	5)	50
AC-45b	1,5 <sup>3)</sup>	1,05	3)			
			L/R (ms)			
DC-40	2,5	1,05	2,5	0,05	5)	24 <sup>4)</sup>
DC-41	1,5	1,05	1,0	0,05	5)	50 <sup>4)</sup>
DC-43	4,0	1,05	2,5	0,05	5)	50 <sup>4)</sup>
DC-45	4,0	1,05	15,0	0,05	5)	50 <sup>4)</sup>
DC-46	1,5 <sup>3)</sup>	1,05	3)	0,05	5)	50 <sup>4)</sup>
Utilization category	Make conditions					
	$I/I_e$	$U_r/U_e$	$\text{Cos } \phi$	On time <sup>2)</sup> s	Off time s	Number of operating cycles
AC-43	10,0	1,05 <sup>6)</sup>	1)	0,05	10	50
AC-44	12,0	1,05 <sup>6)</sup>	1)	0,05	10	50
<i>I</i>	Current made. The making current is expressed in d.c. or a.c. r.m.s. symmetrical values but it is understood that for a.c. the peak value of the asymmetrical current corresponding to the power factor of that circuit may assume a higher value					
$I_c$	Current made and broken, expressed in d.c. or a.c. r.m.s. symmetrical values					
$I_e$	Rated operational current					
<i>U</i>	Applied voltage					
$U_r$	Power frequency recovery voltage					
$U_e$	Rated operational voltage					
$\text{Cos } \phi$	Power factor of test circuit					
L/R	Time constant of test circuit					
<p>1) <math>\text{Cos } \phi</math> is 0,45 for <math>I_e \leq 100</math> A, 0,35 for <math>I_e &gt; 100</math> A.</p> <p>2) Time may be less than 0,05 s provided that contacts are allowed to become properly seated before re-opening.</p> <p>3) Tests to be carried out with an incandescent light load.</p> <p>4) Half the operations with one polarity and the other half with reverse polarity.</p> <p>5) See table 10.</p> <p>6) For <math>U/U_e</math> a tolerance of <math>\pm 20</math> % is accepted.</p> <p>7) The make conditions shall also be verified. The verification may be made during the make break test, but only with the manufacturer's agreement. In this case, the making current multiples shall be as shown for <math>I/I_e</math> and the breaking current as shown for <math>I_c/I_e</math>. Twenty-five operating cycles shall be made at a control supply voltage equal to 110 % of the rated control supply voltage <math>U_s</math> and 25 operating cycles at 85 % of <math>U_s</math>. The off-times are to be determined from table 10.</p>						

**Table 10 – Relationship between current broken  $I_c$  and OFF time for the verification of rated making and breaking capacities**

Current broken $I_c$ A	OFF time s
$I_c \leq 100$	10
$100 < I_c \leq 200$	20
$200 < I_c \leq 300$	30
$300 < I_c \leq 400$	40
$400 < I_c \leq 600$	60
$600 < I_c \leq 800$	80
$800 < I_c \leq 1\,200$	100
$1\,000 < I_c \leq 1\,300$	140
$1\,300 < I_c \leq 1\,600$	180
$1\,600 < I_c$	240

#### 8.2.4.2 Operational performance

Subclause 7.2.4.2 of Part 1 applies with the following additions:

a) *Conventional operational performance after making breaking capacity tests*

CPS's shall be capable of making and breaking currents after making/breaking capacity tests, without failure under the conventional conditions stated in table 11 for the required utilization categories and the number of operating cycles indicated.

ON time shall be 0,05 s. It may be less than 0,05 s provided that contacts are allowed to become properly seated before re-opening.

OFF time shall be not greater than the values specified in table 10 except for utilization categories AC-45b and DC-46 where the OFF time shall be 60 s.

b) *Operational performance before and after short-circuit tests at  $I_{cr}$  and  $I_{cs}$*

CPS's shall be capable of making and breaking currents before and after short-circuit tests at  $I_{cr}$  and  $I_{cs}$  (see 8.2.5 a)) without failure under the conditions stated in table 12 for the required utilization categories and the number of operating cycles indicated. The first 25 operating cycles after the  $I_{cs}$  short circuit test shall be performed by the local manual operating means, if any, the control function circuit being energized. A local manual operating means may be activated locally or remotely (e.g. handle, motor drive, solenoid etc.).

For all but the above 25 operating cycles, ON time shall be 0,05 s. It may be less than 0,05 s provided that contacts are allowed to become properly seated before re-opening and the OFF time shall be not greater than the values specified in table 10 except for utilization categories AC-45b and DC-46 where the OFF time shall be 60 s.

c) *Conventional mechanical operational performance*

In addition to the electrical operational performance requirements of item a) CPS's shall be capable of effecting mechanical close-open operating cycles without current in accordance with table 11 and under the test conditions specified in 9.4.2.2.

For CPS's which can be fitted with under-voltage and/or shunt releases 10 % of the total number of operating cycles shall be closing-tripping operations for each release, 5 % at the beginning and 5 % at the end of the test.

**Table 11 – Conventional operational performance after making/breaking capacity tests**

Conditions for making and breaking corresponding to the several utilization categories and number of operating cycles.

Category	$I_c/I_e$	$U_r/U_e$	$\cos \phi^{4)}$	Number of operating cycles	
				with current	without current
AC-40	1,0	1,05	0,8	3 000	4 000
AC-41	1,0	1,05	0,8	6 000	4 000
AC-42	2,0	1,05	0,65	6 000	4 000
AC-43	2,0	1,05	1)	6 000	4 000
AC-44	6,0	1,05	1)	6 000	4 000
AC-45a	2,0	1,05	0,45	6 000	4 000
AC-45b	1,0 <sup>2)</sup>	1,05	2)		
			L/R (ms) <sup>5)</sup>		
DC-40	1,0	1,05	2,5	3 000 <sup>3)</sup>	4 000
DC-41	1,0	1,05	1,0	6 000 <sup>3)</sup>	4 000
DC-43	2,5	1,05	2,5	6 000 <sup>3)</sup>	4 000
DC-45	2,5	1,05	15,0	6 000 <sup>3)</sup>	4 000
DC-46	1,0 <sup>2)</sup>	1,05	2)	6 000 <sup>3)</sup>	4 000

See notes, table 12.

**Table 12 – Operational performance before and after short-circuit tests at  $I_{cr}$  and  $I_{cs}$**

Conditions for making and breaking corresponding to the several utilization categories.

Category	Value of the rated operational current	Make			Break			Number of operating cycles before and after	
		$I/I_e$	$U/U_e$	$\text{Cos } \phi$ 4)	$I_e$	$U_r/U_e$	$\text{Cos } \phi$ 4)	$I_{cr}$	$I_{cs}$
AC-40	(all values)	1	1	0,8	1	1	0,8	1 500	750
AC-41	(all values)	1	1	0,95	1	1	0,95	3 000	1 500
AC-42	(all values)	2,5	1	0,65	2,5	1	0,65	3 000	1 500
AC-43	$I_e \leq 17A$	6	1	0,65	1	0,17	0,65	3 000	1 500
	$I_e > 17A$	6	1	0,35	1	0,17	0,35	3 000	1 500
AC-44	$I_e \leq 17A$	6	1	0,65	6	1	0,65	3 000	1 500
	$I_e > 17A$	6	1	0,35	6	1	0,35	3 000	1 500
AC-45a	(all values)	2	1	0,45	2	1	0,45	3 000	1 500
AC-45b	(all values)	1 2)	1	L/R (ms) 5)	1 2)	1	L/R (ms) 5)	3 000	1 500
DC-40	(all values)	1	1	1	1	1	1	1 500	750
DC-41	(all values)	1	1	1	1	1	1	3 000	1 500
DC-43	(all values)	2,5	1	2	2,5	1	2	3 000	1 500
DC-45	(all values)	2,5	1	7,5	2,5	1	7,5	3 000	1 500
DC-46	(all values)	1	1	2)	1	1	2)	3 000	1 500
<p><math>I</math> Current made. In a.c. the conditions for making are expressed in r.m.s. values but it is understood that the peak value of asymmetrical current, corresponding to the power-factor of the circuit, may assume a higher value</p> <p><math>I_c</math> Current made or broken. Except for AC-45b or DC-46, the making current is expressed in d.c. or a.c. r.m.s. symmetrical values but it is understood that the actual value will be the peak value corresponding to the power-factor of the circuit</p> <p><math>I_e</math> Rated operational current</p> <p><math>U_r</math> Power frequency or d.c. recovery voltage</p> <p><math>U</math> Applied voltage</p> <p><math>U_e</math> Rated operational voltage</p> <p><math>\text{Cos } \phi</math> Power factor of test circuit</p> <p><math>L/R</math> Time constant of test circuit</p>									
<p>1) <math>\text{Cos } \phi</math> is 0,45 for <math>I_e \leq 100 A</math>, 0,35 for <math>I_e &gt; 100 A</math>.</p> <p>2) Test to be carried out with an incandescent light load.</p> <p>3) Half of the operating cycles with one polarity and the other half with reverse polarity.</p> <p>4) Tolerance for <math>\text{Cos } \phi</math>: <math>\pm 0,05</math>.</p> <p>5) Tolerance for <math>L/R</math>: <math>\pm 15 \%</math>.</p>									

### 8.2.4.3 Durability

Subclause 7.2.4.3 of Part 1 applies.

#### 8.2.4.3.1 Mechanical durability

Subclause 7.2.4.3.1 of Part 1 applies with the following additions:

Mechanical durability of a CPS is verified by a special test conducted at the discretion of the manufacturer.

Recommendations for conducting this test are given in clause A.2 of annex A.

#### 8.2.4.3.2 Electrical durability

Subclause 7.2.4.3.2 of Part 1 applies with the following additions:

Electrical durability of a CPS is verified by a special test conducted at the discretion of the manufacturer.

Recommendations for conducting this test are given in clause A.3 of annex A.

#### 8.2.5 Ability to make, carry and break short-circuit currents

The CPS shall be capable of withstanding, the thermal, dynamic and electrical stresses, resulting from short-circuit currents.

Short-circuit currents may be encountered during current making, current carrying in the closed position and current interruption.

- a) The ability of the CPS to make, carry and break short-circuit currents is stated in terms of the following:
  - Prospective conventional short-circuit currents  $I_{cr}$  and "r" current ( $I_r$ );
  - Rated service short-circuit breaking capacity  $I_{cs}$  (see 5.3.6.1).
- b) An additional test of three making and breaking operations shall be made at a current equal to 80 % of the instantaneous maximum tripping value of the instantaneous tripping release if this 80 % value exceeds the value of the  $I_c/I_e$  given in table 9 (see 9.4.5).
- c) Four-pole CPS's shall comply with the requirements of 9.3.4.1.6 items a), b), c), as applicable.

**Table 13 – Prospective conventional test current  $I_{cr}$  and "r" current ( $I_r$ ) as a function of the maximum  $I_e$  for a given construction**

Maximum $I_e$ for a given construction	$I_{cr}$		"r" current ( $I_r$ ) kA
	$(I_{cr})/(I_e \text{ max.})$	min. kA	
A			
$0 < I_e \leq 16$	30	0,2	1
$16 < I_e \leq 32$	30	0,2	3
$32 < I_e \leq 63$	25	1	3
$63 < I_e \leq 125$	20	1,6	5
$125 < I_e \leq 250$	20	1,6	10
$250 < I_e \leq 315$	15	5	10
$315 < I_e \leq 630$	15	5	18

The power-factor or the time-constant shall be according to table 16 of IEC 60947-1.

**A1** Subclause deleted **A1**

### 8.3 Electromagnetic compatibility (EMC)

#### 8.3.1 General

Subclause 7.3.1 of part 1 applies with the following addition:

Power frequency magnetic field tests are not required because such devices are naturally submitted to such fields. Immunity is demonstrated by the successful completion of the operating capability tests (see 9.3.3.5 and 9.3.3.6).

#### 8.3.2 Immunity

Subclause 7.3.2 of IEC 60947-1 applies with the following additions:

**Table 14 – Acceptance criteria when EM disturbances are present**

Item	Acceptance criteria		
	A	B	C
Overall performance	No noticeable changes of the operating characteristic Operating as intended	Temporary degradation or loss of performance which is self-recoverable	Temporary degradation or loss of performance which requires operator intervention or system reset
Operation of power and control circuits	No maloperation according to the basis given under 1)	Temporary maloperation which cannot cause tripping according to the basis given under 2); unintentional separation or closure of contact is not accepted Self-recoverable	Tripping of overload relay; unintentional separation or closure of contact
Operation of displays, control panels and auxiliary circuits	No changes to display information Only slight light intensity fluctuation of LEDs, or slight movement of characters	Temporary visible changes or loss of information Undesired LED illumination No maloperation of auxiliary contacts	Shut down Permanent loss of display or wrong information Unpermitted operating mode Maloperation of auxiliary contacts Not self-recoverable
Information processing and sensing functions	Undisturbed communication and data interchange to external devices	Temporarily disturbed communication, with error reports of the internal and external devices	Erroneous processing of information Loss of data and/or information Errors in communication Not self-recoverable
<p>1) Acceptance criteria A is based on the result of the following test procedure: during the test, the CPS when loaded at 0,9 times the current setting shall not trip, and when loaded at 2,0 times the current setting it shall trip within 0,9 times the minimum value and 1,1 times the maximum value of the manufacturer's time current characteristic, and the monitoring functions, if any, shall correctly indicate the status of the CPS.</p> <p>2) Acceptance criteria B is based on the result of the following test procedure: during the test, the CPS when loaded at 0,9 times the current setting shall not trip. After the test, the CPS shall comply with the manufacturer's time current characteristic when loaded at 2,0 times the current setting and the monitoring functions, if any, shall correctly indicate the status of the CPS.</p>			

The test values and procedures are given in 9.3.5.2.



### 8.3.3 Emission

#### 8.3.3.1 Equipment not incorporating electronic circuits

Subclause 7.3.3.1 of part 1 applies.

#### 8.3.3.2 Equipment incorporating electronic circuits

Subclause 7.3.3.2 of part 1 applies.

The test values and procedures are given in 9.3.3.3.

## 9 Tests

### 9.1 Kind of tests

#### 9.1.1 General

Subclause 8.1.1 of Part 1 applies.

#### 9.1.2 Type test

Subclause 8.1.2 of Part 1 applies.

#### 9.1.3 Routine tests

Subclause 8.1.3 of Part 1 applies.

Routine tests comprise:

- operation and operating limits (9.5.2);
- dielectric tests (9.5.3).

NOTE The combined test of 8.3.3.4.2 of IEC 60947-1 is permitted.

#### 9.1.4 Sampling tests

**A1** Sampling tests for clearance verification shall be made in accordance with 8.3.3.4.3 of IEC 60947-1.

If by the control of materials and manufacturing processes, the integrity of the dielectric properties has been proven, the routine tests may be replaced by sampling tests according to a recognized sampling plan (see IEC 60410).

The combined test of 8.3.3.4.2 of IEC 60947-1 is permitted. **A1**

#### 9.1.5 Special tests

These tests are done either at the discretion of the manufacturer or by agreement between manufacturer and user. These tests (see annex A) apply to:

- mechanical durability;
- electrical durability.

## 9.2 Compliance with constructional requirements

Subclause 8.2 of IEC 60947-1 applies.

## 9.3 Compliance with performance requirements

In order to avoid repetition of identical texts applicable to the various test sequences, the general test conditions have been grouped together at the beginning of this subclause under three headings:

- test conditions applicable to all sequences (9.3.2);
- performance under no load, normal load and overload conditions (9.3.3);
- test conditions applicable to short-circuit tests (9.3.4).

Throughout this clause, the term "test" has been used for every test to be made; "verification" should be interpreted as "test for the verification" and has been used where it is intended to verify the condition of the CPS following an earlier test in a sequence whereby it may have been adversely affected.

### 9.3.1 Test sequences

Type tests are grouped together in a number of sequences as shown in table 16 of 9.4.

### 9.3.2 General test conditions

#### 9.3.2.1 General requirements

Subclause 8.3.2.1 of Part 1 applies with the following additions:

The number of samples to be tested for each test sequence and the test conditions (e.g. setting of overload releases, terminal connections), are specified in table 16.

Unless otherwise specified, tests are to be performed on a CPS having the maximum rated operational current(s) of a given physical size and similar construction, and are deemed to cover all rated currents of that physical size and construction.

NOTE Some utilization categories may be assigned without tests or with a restricted number of tests, when tests of equivalent or higher severity have already been made (see 5.4.2).

#### 9.3.2.2 Test quantities

Subclause 8.3.2.2 of Part 1 applies.

#### 9.3.2.3 Evaluation of test results

The condition of the CPS after tests shall be checked by the verifications required for each sequence.

A CPS is deemed to have met the requirements of this standard if it meets the requirements of each sequence as applicable.

#### 9.3.2.4 Test reports

Subclause 8.3.2.4 of Part 1 applies.

### 9.3.3 Performance under no load, normal load and overload conditions

#### 9.3.3.1 Operation

Tests shall be made to verify that the equipment operates correctly according to the requirements of 8.2.1.1.

#### 9.3.3.2 Operating limits

Subclause 8.3.3.2 of Part 1 applies with the following additions:

The ambient air temperature shall be measured as for the temperature-rise test (see 8.3.3.3.1 of Part 1).

When the over-current opening release is normally a built-in part of the CPS, it shall be verified inside the corresponding CPS. Any separate release shall be mounted approximately as under normal service conditions. The complete CPS shall be mounted in accordance with 9.3.2.1. The CPS under test shall be protected against undue external heating or cooling.

**A1)** The connections of the CPS or, if appropriate, of any separate release shall be made using conductors in accordance with Tables 9, 10 and 11 of IEC 60947-1 for test currents corresponding to

- 100 % of the current setting of the overload relay for overload relays of trip classes 2, 3, 5 and 10A for all overload relay types (see Table 3) and 10, 20, 30 and 40 for electronic overload relay types;
- 125 % of the current setting of the overload relay for thermal overload relays of trip classes 10, 20, 30 and 40 (see Table 3) and for overload relays for which a maximum tripping time greater than 40 s is specified (see 5.7.2). **A1)**

For CPS's with adjustable over-current releases, the tests shall be made at minimum and maximum current settings.

The tests may be made at any convenient voltage.

#### 9.3.3.3 Temperature-rise

##### 9.3.3.3.1 Ambient air temperature

Subclause 8.3.3.3.1 of Part 1 applies.

##### 9.3.3.3.2 Measurement of the temperature of parts

Subclause 8.3.3.3.2 of Part 1 applies.

##### 9.3.3.3.3 Temperature-rise of a part

Subclause 8.3.3.3.3 of Part 1 applies.

#### 9.3.3.3.4 Temperature-rise of the main circuit

Ⓐ) Subclause 8.3.3.3.4 of IEC 60947-1 applies with the exception that a single test shall be conducted with all poles in the main circuit loaded at their individual maximum rated currents and as stated in 8.2.2.4, and with the following additions. Ⓐ)

The main circuit shall be loaded as stated in 8.2.2.4.

All auxiliary circuits which normally carry current shall be loaded at their maximum rated operational current (see 5.6) and the control circuits shall be energized at their rated voltages (see 5.5).

For four-pole CPS's, a test shall first be made on the three poles which incorporate over-current releases. For CPS's having a value of conventional thermal current not exceeding 63 A, a separate and additional test shall be made by passing the test current through the fourth pole and its adjacent pole. For higher thermal current values, the method of testing shall be the subject of a separate agreement between manufacturer and user. The test shall be made in test sequence I (see 9.4.1.1).

#### 9.3.3.3.5 Temperature-rise of control circuits

Subclause 8.3.3.3.5 of Part 1 applies.

#### 9.3.3.3.6 Temperature-rise of coils of electromagnets

Subclause 8.3.3.3.6 of Part 1 applies with the following addition:

- a) Electromagnets of CPS's intended for uninterrupted or 8 h duty shall be subjected only to the conditions prescribed in 8.2.2.6.1, with the corresponding rated current flowing through the main circuit for the duration of the test.
- b) Electromagnets of CPS's intended for intermittent duty shall be subjected to the test as stated above, and also to the test prescribed in 8.2.2.6.2 dealing with their class, with no current flowing through the main circuit.
- c) Specially rated (short-time or periodic duty) windings shall be tested as stated in 8.2.2.6.3 without the current in the main circuit.

#### 9.3.3.3.7 Temperature-rise of auxiliary circuits

Subclause 8.3.3.3.7 of Part 1 applies.

#### 9.3.3.4 Dielectric properties

Subclause 8.3.3.4 of IEC 60947-1 applies with the following modifications.

##### 9.3.3.4.1 Type tests

Ⓐ) Subclause 8.3.3.4.1 of IEC 60947-1 applies with the following modifications.

- Insert the following paragraphs after the second paragraph of item 2) b):

Circuits of a CPS including devices which have been subjected to  $U_{imp}$  test voltages lower than those specified in 7.2.3.1 and 8.3.3.4.1 of IEC 60947-1 may be disconnected for the test, provided they are not connected between phase and earth, according to the manufacturer's instructions. Ⓐ)

**A1** Where the control circuit normally connected to the main circuit is disconnected, the method used to maintain the main contacts closed shall be indicated in the test report.

- Insert the following paragraph after the first paragraph after note 1 of item 7).

Where the control circuit normally connected to the main circuit is disconnected, the method used to maintain the main contacts closed shall be indicated in the test report.

- Replace the sentence of item 8) by the following:

For CPS suitable for isolation, the leakage current shall be measured through each pole with the contacts in the open position, at a test voltage of  $1,1 U_e$ , and shall not exceed 0,5 mA. **A1**

#### **9.3.3.4.2 Routine tests**

Subclause 8.3.3.4.2 of IEC 60947-1 applies.

#### **9.3.3.5 Making and breaking capacities**

##### **9.3.3.5.1 General test conditions**

Subclause 8.3.3.5.1 of Part 1 applies with the following additions.

The tests shall be made under operating conditions stated in table 9.

The control supply voltage shall be 100 % of  $U_s$  except that for the making test of utilization categories AC-43 and AC-44, the control supply voltage shall be 110 % of  $U_s$  for half the number of operating cycles and 85 % of  $U_s$  for the other half.

Connections to the main circuit shall be similar to those intended to be used when the CPS is in service. If necessary, or for convenience, the control and auxiliary circuits and, in particular, the operating coil of the CPS may be supplied from an independent source. Such a source shall deliver the same kind of current and the same voltage as specified for service conditions.

The overload relay may be short-circuited for the purpose of carrying out the rated making and breaking capacity tests.

##### **9.3.3.5.2 Test circuit**

Subclause 8.3.3.5.2 of Part 1 applies.

##### **9.3.3.5.3 Characteristics of transient recovery voltage**

Subclause 8.3.3.5.3 of Part 1 applies.

##### **9.3.3.5.4 **A1** Vacant **A1****

### 9.3.3.5.5 Test procedure for making and breaking capacities

Subclause 8.3.3.5 of Part 1 applies with the following additions:

1) *Test procedure for utilization categories other than AC-44*

The CPS shall perform the making and breaking operations stated in 8.2.4.1 and table 9.

CPS's of utilization category AC-43 shall be subjected to 50 making only operations followed by 50 making and breaking operations.

2) *Test procedure for utilization category AC-44*

The CPS shall make and break the currents given in table 9.

The 50 making only operations shall be done first followed by 50 making and breaking operations.

The load circuit shall be connected to the CPS in the same way as a motor. For reversing CPS's incorporating two devices A and B, these shall be wired and used as in normal application. Each sequence of 50 operations shall be:

close A – open A – close B – open B – off period.

The change-over from "open A" to "close B" shall be made as fast as the normal control system will allow. Mechanical and/or electrical interlocking means provided in the reversing CPS or intended for associating CPS's as reversing devices shall be used.

If the reversing circuit arrangement is such that both CPS's can be energized simultaneously, 10 additional sequences shall be made with both CPS's energized simultaneously.

### 9.3.3.5.6 Behaviour of the CPS during and condition after making and breaking, changeover and reversing tests

- a) There shall be neither arcing nor flashover between poles, or between poles and frame, and no melting of the fuse element F in the leakage detection circuit (see 8.3.4.1.2 of Part 1), and no welding of contacts.
- b) After the test with the CPS in the ON position it shall be verified that there is continuity between each pair of line and load terminals.
- c) **A1** Verification of no welding of the contacts shall be carried out as follows:

In the case of CPSs with manual operating means, there shall be no circuit continuity between any line and load terminals first with the manual operating means in closed position with no control supply voltage present and then by opening the manual operating means with the control supply voltage present. In the case of CPSs without manual operating means, it shall be verified that, with all the remote closing means in the closed position by opening each of the remote opening means in turn there is no circuit continuity between any line and load terminals. **A1**

NOTE To ensure the correct procedure for this verification it may be necessary to refer to the manufacturer's instructions.

### 9.3.3.6 Operational performance capability

Subclause 8.3.3.6 of Part 1 applies with the following additions:

Tests concerning the verification of conventional operational performance are intended to verify that a CPS is capable of fulfilling the requirements given in table 11 and after short-circuit tests at  $I_{cr}$  or  $I_{cs}$ , the requirements under the conditions given in table 12.

Connections to the main circuit shall be similar to those intended to be used when the CPS is in service.

The overload relay may be short-circuited for the purpose of carrying out the tests.

The test circuit given in 9.3.3.5.2 is applicable.

The control voltage shall be 100 % of the rated control supply voltage.

#### **9.3.4 Performance under short-circuit conditions**

Subclause 8.3.4 of Part 1 applies.

##### **9.3.4.1 General conditions for short-circuit tests**

###### **9.3.4.1.1 General requirements**

Subclause 8.3.4.1.1 of Part 1 is amplified as follows:

CPS's shall be tested in free air. For rated service short-circuit breaking capacity tests, a wire mesh shall be placed at all points of the CPS likely to be a source of external phenomena capable of producing a breakdown, in accordance with the arrangements and distances specified by the manufacturer. Details, including distance from the CPS under test to wire-mesh, shall be stated in the test report. CPS's intended for use in an individual enclosure shall, in addition, be tested in the smallest of such enclosure stated by the manufacturer according to test sequence VII.

NOTE An individual enclosure is an enclosure designed and dimensioned to contain one CPS only together with ancillary equipment if any.

This additional test shall be made on a new sample and shall consist in a sequence of operation O-t-CO-t-rCO (see 9.3.7) followed by a verification of dielectric withstand in accordance with 9.4.2.3.

If a CPS is fitted with adjustable over-current releases, the setting of the releases shall be as specified for each test sequence.

For CPS's without over-current releases but fitted with a shunt release, this release shall be energized by the application of a voltage equal to 70 % of the rated control supply voltage of the release (see 8.2.1.4), at a time not earlier than that of the initiation of the short-circuit nor later than 10 ms after the initiation of the short-circuit.

For all these tests, the line side of the test circuit shall be connected to the corresponding terminals of the CPS as marked by the manufacturer. In the absence of such markings, the test connections shall be as specified in table 16.

###### **9.3.4.1.2 Test circuit**

Subclause 8.3.4.1.2 of Part 1 applies.

###### **9.3.4.1.3 Power-factor of the test circuit**

Subclause 8.3.4.1.3 of Part 1 applies.

###### **9.3.4.1.4 Time constant of the test circuit**

Subclause 8.3.4.1.4 of Part 1 applies.

#### 9.3.4.1.5 Calibration of the test circuit

Subclause 8.3.4.1.5 of Part 1 applies.

#### 9.3.4.1.6 Test procedure

Subclause 8.3.4.1.6 of Part 1 applies with the following amplification.

Tests for the performance under short-circuit conditions shall be made according to test sequences III and IV (9.4.3 and 9.4.4).

For CPS's having a rated current up to and including 630 A, a conductor of 75 cm length, having a cross-part as specified in 9.3.3.2 should be included as follows:

- 50 cm on the supply side;
- 25 cm on the load side.

The following symbols are used for defining the operating sequences:

- O represents a breaking operation
- CO represents a manual making operation, the control circuit being previously energized, followed by a breaking operation. In the absence of manual operating means, operating sequence rCO shall apply instead
- rCO represents a remote controlled making operation (by energization of the control circuit) followed by a breaking operation
- $t$  represents the time interval between two successive short-circuit operations which shall be 3 min or the resetting time of the CPS whichever is the longer. The actual value of  $t$  shall be stated in the test report.

The maximum value of  $I^2t$  (see 2.5.18 of Part 1) during these tests shall be recorded in the test report.

NOTE The maximum value of  $I^2t$  recorded during the tests may not be the maximum possible value for the prescribed conditions. Additional tests are necessary if this maximum value needs to be determined.

#### *Four pole CPS*

- a) For a four-pole CPS having four equally rated poles, the tests shall be made on three poles according to figure 11 of Part 1.
- b) For a four-pole CPS having a fourth pole of reduced short-circuit rating, the tests shall be made on the three main poles according to figure 11 of Part 1; an additional test shall be made on the fourth pole and its adjacent pole at an applied voltage of  $U_e/\sqrt{3}$  using the test-circuit according to figure 12 of Part 1 (see note 3 on that figure). The test current shall be that which corresponds to the rating of the fourth pole.
- c) For a four-pole CPS having a switched neutral pole (see 7.1.8 of Part 1), the test shall be made on the four poles according to figure 12 of Part 1.

#### 9.3.4.1.7 Behaviour of the CPS during short-circuit making and breaking tests

Subclauses 9.3.3.5.6a) and 9.3.3.5.6c) apply. After rearming Subclause 9.3.3.5.6b) applies.

Moreover the case shall not be broken but hairline cracks are acceptable.

NOTE Hairline cracks are a consequence of high gas pressure or thermal stresses due to arc extinction when interrupting very high fault currents and are of a superficial nature. Consequently, they do not develop through the entire thickness of the moulded case of the device.



The door, or cover of the enclosure if any, shall not be blown open and it shall be possible to open it.

#### 9.3.4.1.8 Interpretation of records

Subclause 8.3.4.1.8 of Part 1 applies.

### 9.3.5 EMC tests

#### 9.3.5.1 General

Subclause 8.4 of IEC 60947-1 applies with the following additions.

With the agreement of the manufacturer, more than one EMC test or all EMC tests may be conducted on one and the same sample, which initially may be new or may have passed test sequences according to 9.3.1. The sequence of the EMC tests may be carried out in any order.

CPS rated at 50 Hz–60 Hz shall be tested at either one of the rated frequencies.

In the case of a range of CPS with identical electronic controls (including dimensions, components, printed circuit board assemblies and enclosure, if any) and the same design of sensors, it is sufficient to test only the sample of this CPS range with the lowest rated current.

The current setting  $I_R$  of the over-current relays or releases shall be adjusted to the minimum value.

Short-time and instantaneous relays or release settings shall each, if applicable, be adjusted to the minimum value but not less than 2,5 times  $I_R$ . Unless otherwise stated in this standard or specified by the manufacturer, performance criterion B applies and it shall be noted in the test report.

Unless otherwise specified in the relevant clause, after the immunity tests, the operating limits of 8.2.1.2 and 8.2.1.5.2, if applicable, shall be verified.

After emission tests, no performance checks are required.

The test report shall also include any special measures that have been taken to achieve compliance, for example the use of shielded or special cables. If auxiliary equipment is used with the device in order to comply with immunity or emission requirements, they shall be included in the report.

Unless otherwise specified in the relevant clauses, the test sample shall be in the open or closed position, whichever is worse, and shall be operated with the rated control supply.

Unless otherwise specified in the relevant clauses, the test sample shall be in free air.

According to their utilization category and to their over-current protection, CPS incorporating electronic circuits shall be grouped into the following utilization groups, and tested accordingly:

- Utilization group A for CPS of utilization categories AC-40, AC-41, AC-45a, AC-45b, DC-40, DC-41 and DC-46, not provided with electronic over-current protection, and for all CPS of utilization categories AC-42, AC-43, AC-44, DC-43 and DC-45.
- Utilization group B for CPS of utilization categories AC-40, AC-41, AC-45a, AC-45b, DC-40, DC-41 and DC-46, provided with electronic over-current protection.

CPS of utilization category AC-41 provided with relays or releases which are sensitive to phase loss and sensitive to a homopolar component shall be subjected to utilization group A tests.

### 9.3.5.2 Immunity

#### 9.3.5.2.1 General

Subclause 8.4.1.2 of IEC 60947-1 applies with the following addition:

Special requirements are specified in 9.3.5.2.2 to 9.3.5.2.8. If, during the EMC tests, conductors have to be connected to the test sample, the cross-part and the type of conductors are optional but shall be in accordance with the manufacturer's literature.

Performance criteria are given in table 14.

#### 9.3.5.2.2 Electrostatic discharges

##### 9.3.5.2.2.1 General

Tests shall be conducted according to IEC 61000-4-2. Except for metallic parts for which contact discharge is made, only air discharge is required. Ten positive and 10 negative pulses shall be applied to each selected point, the time interval between each successive single discharge being 1 s. Terminals are not required to be tested.

Tests are not possible if the device is an open frame or of degree of protection IP00. In this case, the manufacturer shall attach a label to the unit advising of the possibility of damage due to static discharges.

##### 9.3.5.2.2.2 Requirements specific to the utilization groups

a) Utilization group A (see 9.3.5.1)

As described in 9.3.5.2.2.1.

b) Utilization group B (see 9.3.5.1)

Tests shall be performed in accordance with 9.3.5.2.2.1 and the requirements 1) and 2) below.

1) Test conditions

The EUT (equipment under test) shall be mounted in a metallic enclosure as shown in figures 2, 3 or 4, as applicable. However, with the agreement of the manufacturer, the test may be carried out in free air.

The distances between the EUT and the metallic enclosure shall be 0,1 m with a tolerance of  $^{+10}_0$  %, except for the front face which shall be installed as in normal use according to the manufacturer's instructions, keeping the dimensions of the aperture to a minimum.

The test circuit shall be in accordance with figure 5. For releases with a phase-loss sensitive feature, the test circuit shall be in accordance with figures 6 or 7, as applicable.

The busbar routing shown in figures 2, 3 and 4 may be varied providing the distance 0,1 m with a tolerance of  $^{+10}_0$  %, to the enclosure is maintained. The actual configuration used shall be shown in the test report.

2) Test procedure

The EUT shall be tested as a floor-standing equipment (see 7.1.2 of IEC 61000-4-2), the test set-up being as shown in figure 8 of this standard.

Direct and indirect discharges shall be applied in accordance with IEC 61000-4-2.

The tests shall be performed:

- with contact discharge at 8 kV,
- with air discharge at 8 kV.

The direct discharge tests shall be performed only on parts of the CPS normally accessible to the user, such as setting means, keyboards, displays, push buttons, etc. The application points shall be stated in the test report.

If a direct discharge on the EUT (air or contact) occurs at any test point, the test at such a point is repeated 10 times, for both polarities, at intervals of  $\geq 1$  s.

Indirect discharges shall be applied at selected points on the surface of the enclosure, the test at such points is repeated 10 times, for both polarities, at intervals of  $\geq 1$  s.

### 9.3.5.2.3 Radiated radio-frequency electromagnetic fields

#### 9.3.5.2.3.1 General

Tests shall be conducted according to IEC 61000-4-3.

The device shall comply with performance criterion A.

#### 9.3.5.2.3.2 Requirements specific to the utilization groups

a) Utilization group A (see 9.3.5.1)

As described in 9.3.5.2.3.1.

b) Utilization group B (see 9.3.5.1)

Tests shall be performed in accordance with 9.3.5.2.3.1 and the requirements 1) and 2) below.

1) Test conditions

The EUT shall be tested in free air unless it is intended to be used only in a specified individual enclosure, in which case it shall be tested in such an enclosure. Details including the dimensions of the enclosure shall be stated in the test report.

The height from the floor of the EUT shall be  $1 \text{ m} \pm 0,1 \text{ m}$ .

The EUT shall be tested on the front face only, the test set-up being as shown in figure 9.

Where an enclosure is used, it shall be connected to the ground plane, according to the manufacturer's instructions.

The test circuit shall be in accordance with figure 5. For releases with a phase loss sensitive feature, the test circuit shall be in accordance with figures 6 or 7, as applicable.

To enable repeatability, the actual test set-up including supply bars, transformer, etc. shall be stated in the test report.

The test level shall be 10 V/m.

Tests shall be performed with both horizontal and vertical antenna polarization.

2) Test procedure

- i) To verify the resistance against unwanted tripping, the EUT shall be supplied with a current of 0,9 times the current setting and the test frequency swept over the range of 80 MHz to 1 000 MHz in accordance with clause 8 of IEC 61000-4-3.

The dwell time for each frequency shall be between 500 ms and 1000 ms and the step size shall be 1 % of the previous frequency.

The actual dwell time shall be stated in the test report.

- ii) To verify the time/current characteristics, the EUT shall be supplied with a current of 2,0 times the current setting.

The tripping time shall then be measured.

The test shall be performed at the following frequencies: 80; 100; 120; 180; 240; 320; 480; 640 and 960 MHz, the test current being applied after the field at each frequency has stabilized.

**9.3.5.2.4 Electrical fast transients/bursts (EFT/B)**

**9.3.5.2.4.1 General**

Tests shall be conducted according to IEC 61000-4-4.

The test level for power lines shall be 2 kV/5 kHz using the coupling/decoupling network. For I/O, signal, data and control ports, the test level shall be 1 kV/5 kHz using the capacitive coupling clamp.

The test voltage shall be applied for the duration of 1 min.

The device shall comply with performance criterion A.

**9.3.5.2.4.2 Requirements specific to the utilization groups**

- a) Utilization group A (see 9.3.5.1)

As described in 9.3.5.2.4.1.

- b) Utilization group B (see 9.3.5.1)

Tests shall be performed according to IEC 61000-4-4 and the requirements 1), 2) and 3) below.

- 1) Test conditions

The EUT shall be mounted in a metallic enclosure as shown in figures 2, 3, or 4, as applicable. However, with the agreement of the manufacturer, the test may be carried out in free air.

The distances between the EUT and the metallic enclosure shall be 0,1 m with a tolerance of  $^{+10}_0$  %, except for the front face which shall be installed as in normal use according to the manufacturer's instructions, keeping the dimensions of the aperture to a minimum.

The metallic enclosure shall be connected to the ground plane.

The test circuit shall be in accordance with figure 13. For releases with a phase loss sensitive feature, the test circuit shall be in accordance with figures 14 or 15, as applicable.

The test level shall be 4 kV on main circuits and on any auxiliary connected to the main circuit, and 2 kV for all auxiliary input/output ports.

2) Test procedure

The EUT shall be tested as a floor-standing equipment (see 7.2.1 of IEC 61000-4-4), the test set-up being shown in figure 16. Disturbances shall be injected at a distance between 0,9 m and 1 m from the EUT.

NOTE 1 It is advisable to supply the transformer via a coupling-decoupling network to avoid disturbances on the mains network.

NOTE 2 The disturbance injection distance is defined in order to ensure test repeatability.

For the a.c. main circuit, the direct injection method shall be used. For auxiliary ports the coupling-decoupling network or clamp injection method shall be used, as applicable.

On the a.c. mains port, the disturbance shall be applied on one phase pole chosen at random, the EUT being supplied from the other phase poles, in accordance with figure 13. For releases which have a phase loss sensitive feature, the test shall be performed as shown in figure 14 for the three-phase poles in series connection and on a phase chosen at random for the three-phase connection shown in figure 15.

Tests shall be performed as follows:

- i) To verify the resistance against unwanted tripping, the EUT shall be supplied with a current of 0,9 times the current setting during the application of the disturbance.  
The disturbance shall be applied for a duration of 1 min.
- ii) To verify the time/current characteristics the CPS shall be supplied with a current of 2,0 times the current setting during the application of the disturbance.

3) Test results

Performance criterion A shall apply. However, temporary changes to the monitoring functions (e.g. unwanted LED illumination) during the tests are acceptable, in which case the correct functioning of the monitoring shall be verified after the tests.

**9.3.5.2.5 Surges (1,2/50  $\mu$ s – 8/20  $\mu$ s)**

**9.3.5.2.5.1 General**

Tests shall be conducted according to IEC 61000-4-5.

**9.3.5.2.5.2 Requirements specific to the utilization groups**

a) Utilization group A (see 9.3.5.1)

The test shall be conducted in accordance with 9.3.5.2.5.1 as well as the following.

Capacitive coupling shall be preferred. The surges shall be applied to all main, control or auxiliary terminals, whether they comprise electronic or conventional contacts.

Terminals for control and auxiliary circuits intended for the connection of conductors which extend more than 3 m shall be tested at 2,0 kV line-to-earth and 1,0 kV line-to-line. Tests are not applicable to protected circuits.

The repetition rate shall be one pulse per minute, with the number of pulses being five positive and five negative.

If the CPS is required to operate in an installation which is less protected, for example installation class 4 or 5 according to IEC 61000-4-5, this shall be specified by the user. In this case, the test levels shall be 4 kV line-to-earth and 2 kV line-to-line.

## b) Utilization group B (see 9.3.5.1)

Tests shall be performed in accordance with 9.3.5.2.5.1 and with the requirements of 1) and 2) below.

## 1) Test conditions

The EUT shall be mounted in a metallic enclosure as shown in figures 2, 3 or 4, as applicable. However, with the agreement of the manufacturer, the test may be carried out in free air.

The distances of the EUT to the metallic enclosure shall be 0,1 m with a tolerance  $^{+10}_0$  %, except for the front face which shall be installed as in normal use according to the manufacturer's instructions, keeping the dimensions of the aperture to a minimum.

The metallic enclosure shall be connected to the ground plane.

The test circuit for the a.c. mains port shall be in accordance with figure 17 (line-to-earth) or figure 18 (line-to-line).

For releases with a phase loss sensitive feature, the test circuits shall be in accordance with figures 19 (line-to-earth) and 20 (line-to-line) or 21 (line-to-earth) and 22 (line-to-line), as applicable.

NOTE It is advisable to supply the transformer via a coupling-decoupling network in order to avoid disturbances on the mains network.

The test level shall be 4 kV (line-to-earth) and 2 kV (line-to-line) on the a.c. main circuit and those auxiliaries intended to be connected to the main circuit, 2 kV (line-to-earth) and 1 kV (line-to-line) for those auxiliaries not intended to be connected to the main circuit.

## 2) Test procedure

On a.c. mains ports the disturbance shall be applied on one phase pole chosen at random, EUT being supplied from the other two phase poles, in accordance with figures 17 (line-to-earth) and 18 (line-to-line). For releases which have a phase loss sensitive feature, the test shall be performed as shown in figures 19 (line-to-earth) and 20 (line-to-line) for the three-phase poles in series connection or on a phase chosen at random for the three-phase connection shown in figures 21 (line-to-earth) and 22 (line-to-line).

Auxiliary port disturbances shall be injected by means of coupling-decoupling networks as specified in figure 6 and figure 7 of IEC 61000-4-5.

Pulses with both positive and negative polarity shall be applied, the phase angles being 0° and 90°.

A series of five pulses is applied for each polarity and each phase angle (total number of pulses: 20), the interval between two pulses being approximately 1 min. A shorter interval may be used by agreement with the manufacturer.

The CPS is supplied with a current of 0,9 times the current setting during the application of the pulses.

### 9.3.5.2.6 Conducted disturbances induced by radio-frequency fields (common mode)

#### 9.3.5.2.6.1 General

Tests shall be conducted according to IEC 61000-4-6.

The device shall comply with performance criterion A.

#### 9.3.5.2.6.2 Requirements specific to the utilization groups

a) Utilization group A (see 9.3.5.1)

As described in 9.3.5.2.6.1.

b) Utilization group B (see 9.3.5.1)

Tests shall be performed in accordance with 9.3.5.2.6.1 and the requirements 1) and 2) below.

1) Test conditions

The EUT shall be tested in free air, unless it is intended to be used only in a specified individual enclosure, in which case it shall be tested in such an enclosure. Details, including the dimensions of the enclosure, shall be stated in the test report.

Where an enclosure is used, it shall be connected to the ground plane, according to the manufacturer's instructions.

To enable repeatability, the actual test set-up including supply bars, transformer, etc. shall be stated in the test report.

Tests shall be performed on the main circuit and those auxiliaries intended to be connected to the main circuit.

The test set-up shall be according to figures 10, 11 or 12, as applicable.

The disturbance shall be injected by means of a coupling-decoupling network M1 or M2 according to 6.2.2 of IEC 61000-4-6, as applicable (see figures 10, 11 and 12).

The ratio between the cross-section "S" (mm<sup>2</sup>) of the connecting cable and its height "h" (cm) from the ground plane shall be 1:5.

The test circuit for the a.c. main circuit port shall be in accordance with figure 10. For releases with a phase loss sensitive feature, the test circuit shall be in accordance with figures 11 or 12, as applicable.

The test level shall be 10 V for main circuit and auxiliary ports.

2) Test procedure

- i) To verify the resistance against unwanted tripping, the EUT shall be supplied with a current of 0,9 times the current setting and the test frequency swept over the range 150 kHz to 80 MHz in accordance with clause 8 of IEC 61000-4-6.

The dwell time for each frequency shall be between 500 ms and 1 000 ms and the frequency step size shall be 1 % of the previous frequency.

The actual dwell time shall be stated in the test report.

- ii) To verify the time/current characteristics, the EUT shall be supplied with a current of 2,0 times the current setting.

The tripping time shall be measured.

The test shall be performed at the following frequencies: 0,150; 0,300; 0,450; 0,600; 0,900; 1,20; 1,80; 2,40; 3,60; 4,80; 7,20; 9,60; 12,0; 19,2; 27,0; 49,4; 72,0 and 80,0 MHz, the test current being applied after the level of the disturbing voltage at each frequency has stabilized.

### 9.3.5.2.7 Harmonics

#### 9.3.5.2.7.1 General

The device shall comply with performance criterion A.

#### 9.3.5.2.7.2 Requirements specific to the utilization groups

**A1** a) Utilization group A (see 9.3.5.1)

Subclause 8.4.1.2 of IEC 60947-1 applies.

b) Utilization group B (see 9.3.5.1)

1) Test conditions

These tests apply to CPS for which the electronic current sensing means are stated by the manufacturer to be r.m.s. responsive.

This shall be indicated either by marking "r.m.s." on the CPS or given in the manufacturer's literature, or both.

The EUT shall be tested in free air unless it is intended to be used only in a specified individual enclosure, in which case it shall be tested in such an enclosure. Details, including the dimensions of the enclosure, shall be stated in the test report.

Where applicable, the tests shall be performed at the rated frequency.

NOTE The test currents may be generated by a source of power based on the utilization of thyristors (see figure 23), saturated cores, programmable power supplies or other appropriate sources.

2) Test currents

The test current waveform shall consist of one of the following two options:

- option a): two waveforms applied successively:
  - a waveform consisting of a fundamental and a third harmonic component;
  - a waveform consisting of a fundamental and a fifth harmonic component.
- option b): a waveform consisting of a fundamental and a third, fifth and seventh harmonic component.

Test currents shall be:

- for option a):

test of the third harmonic and peak factor

- 72 % of fundamental component  $\leq$  third harmonic  $\leq$  88 % of fundamental component;
- peak factor:  $2,0 \pm 0,2$ ;

test of the fifth harmonic and peak factor

- 45 % of fundamental component  $\leq$  fifth harmonic  $\leq$  55 % of fundamental component;
- peak factor:  $1,9 \pm 0,2$ ;

–

<http://www.china-gauges.com/>



for option b):

the test current, for each period, consists of two equal opposite half-waves defined as follows:

- current conduction time, for each half-wave is  $\leq 21$  % of the period,
- peak factor:  $\geq 2,1$ .

NOTE 1 The peak factor is the peak value of the current divided by the r.m.s. value of the current wave. For the relevant formula, see figure 23.

NOTE 2 This test current for option b) has at least the following harmonic content of the fundamental component:

- third harmonic  $> 60$  %;
- fifth harmonic  $> 14$  %;
- seventh harmonic  $> 7$  %.

Higher harmonics may also be present.

NOTE 3 The test current waveform for option b) may be produced, for example, by two back-to-back thyristors (see figure 23).

NOTE 4 The test currents  $0,9 I_R$  and  $2,0 I_R$  (see performance criterion A) are the r.m.s. values of the composite waveforms.

### 3) Test procedure

The tests shall be performed on any two-phase poles, chosen at random in accordance with 8.2.1.5.1 carrying the test current at any convenient voltage, connections being in accordance with figure 5. For releases with a phase loss sensitive feature, connections shall be made in accordance with figures 6 or 7, as applicable.

Under-voltage releases, if any, shall either be energized or disabled. All other auxiliaries shall be disconnected during the test.

The duration of the test to verify the immunity to unwanted tripping (at  $0,9$  times the current setting) shall be  $10$  times the tripping time which corresponds to twice the current setting.

#### 9.3.5.2.8 Current dips and short time interruptions

A CPS is inherently responsive to dips and short-time interruptions on the control supply; it shall react within the limits of 8.2.1.2, and this is verified by the operating limits tests given in 9.3.3.2.

However, under rated control supply voltage (or current), the power circuit of CPS of utilization category AC-40, AC-41, AC-45a, AC-45b, DC-40, DC-41 and DC-46 provided with electronic circuits may be declared as not sensitive to perturbation, which shall be verified as defined hereafter.

#### 1) Test procedure

The EUT shall be tested in free air unless it is intended to be used only in a specified individual enclosure, in which case it shall be tested in such an enclosure. Details, including the dimensions of the enclosure, shall be stated in the test report.

The test circuit shall be in accordance with figure 5 on any two-phase poles chosen at random. For releases with a phase loss sensitive feature, the test circuit shall be in accordance with figures 6 or 7, as applicable.

The tests shall be performed with a sinusoidal current at any convenient voltage. The current shall be applied according to figure 24 and to table 15 where  $I_R$  is the setting current,  $I_D$  is the dip test current and  $T$  is the period of the sinusoidal current.

**A1)** Note deleted **A1)**

The duration of each test shall be between three and four times the maximum tripping time corresponding to twice the current setting, or 10 min, whichever is the lower.

**Table 15 – Test parameters for current dips and interruptions**

Test no.	$I_D$	
1		0,5 $T$
2		1 $T$
3		5 $T$
4		25 $T$
5		50 $T$
6	0,4 $I_R$	10 $T$
7		25 $T$
8		50 $T$
9	0,7 $I_R$	10 $T$
10		25 $T$
11		50 $T$

2) Test results

Performance criterion B of table 14 shall apply, except that the after-test verification is not required.

**9.3.5.3 Emission**

Subclause 8.4.2 of IEC 60947-1 applies with the following additions:

**9.3.5.3.1 Conducted radio-frequency emission tests**

A description of the test, the test method and the test set-up are given in CISPR 11.

a) Utilization group A (see 9.3.5.1)

- limits of table 2a of CISPR 11, group 1, apply for environment A;
- limits of table 2b of CISPR 11, group 1, apply for environment B.

b) Utilization group B (see 9.3.5.1)

- limits of table 2a of CISPR 11, group 1, apply for environment A;
- limits of table 2b of CISPR 11, group 1, apply for environment B.

**9.3.5.3.2 Radiated radio-frequency emission tests**

**9.3.5.3.2.1 General**

A description of the test, the test method and the test set-up is given in CISPR 11.

Tests are required where the control and/or auxiliary circuits contain components with fundamental switching frequencies greater than 9 kHz, for example switch-mode power supplies, etc.

**9.3.5.3.2.2 Requirements specific to the utilization groups**

a) Utilization group A (see 9.3.5.1)

Limits of table 3 of CISPR 11 apply, according to the given class of environment.

b) Utilization group B (see 9.3.5.1)

Tests shall be performed according to 9.3.5.3.2.1 and the requirements of 1), 2) and 3) below.

1) Test conditions

The EUT shall be tested in free air unless it is intended to be used only in a specified individual enclosure, in which case it shall be tested in such an enclosure. Details, including the dimensions of the enclosure, shall be stated in the test report.

NOTE It is recognized that the presence of an enclosure may cause interference at certain frequencies.

The height from the floor of the EUT shall be  $1\text{ m} \pm 0,1\text{ m}$ .

The test circuit shall be in accordance with figure 5. For releases with a phase loss sensitive feature, the test circuit shall be in accordance with figures 6 or 7, as applicable.

The test set-up is shown in figure 25.

To enable repeatability, the actual test set-up including supply bars, transformer, etc. shall be stated in the test report.

2) Test procedure

Under-voltage releases, if any, shall either be energized or disabled. All other auxiliaries shall be disconnected during the test.

3) Test results

Limits of table 3 of CISPR 11 apply, according to the given class of environment.

### 9.3.5.3.3 Harmonics

The electronic control circuits operate at very low power and hence create negligible disturbances; as a result, no tests are required.

### 9.3.5.3.4 Voltage fluctuations

The electronic control circuits operate at very low power and hence create negligible disturbances; as a result, no tests are required.

## 9.4 Test sequences

CPS's shall be tested according to the sequences given in table 16. For each sequence, the tests shall be made in the order listed.

Table 16 – Test sequences

Test sequence No.	Tests	Test Clause	Performance Clause	$U_e/I_e$	$U_e/I_{cs}$	Test sample		Setting of release 3)
						Quantity	No. 4)	
I	– Temperature-rise (for $I_e$ maximum) – Operation – Operating limits – Dielectric properties	9.4.1.1 9.4.1.2 9.4.1.3 9.4.1.4	8.2.2 8.2.1 8.2.1 8.2.3			1 6)		
II	– Rated making and breaking capacity – Conventional operational performance electrical-mechanical – Dielectric withstand verification	9.4.2.1 9.4.2.2 9.4.2.3	8.2.4.1 8.2.4.2 (a + c) 9.3.3.4	5)		1 6)		
III	– Operational performance at $U_e/I_e$	9.4.3.1	8.2.4.2 b)	5)		2	1	Max.
	– Rated breaking capacity at $I_{cr}$	9.4.3.2	8.2.5 a)					
	– Operational performance at $U_e/I_e$	9.4.3.1	8.2.4.2 b)					
	– Dielectric withstand verification	9.4.3.4	9.3.3.4					
	– Overload releases verification	9.4.3.5	8.2.1.5					
	– Rated breaking capacity at $I_r$	9.4.3.2	8.2.5 a)					
IV	– Dielectric withstand verification	9.4.3.4	9.3.3.4	5)			2	Max.
	– Overload releases verification	9.4.3.5	8.2.1.5					
	– Operational performance $U_e/I_e$	9.4.4.1	8.2.4.2b)					
	– Rated service short-circuit breaking capacity at $I_{cs}$	9.4.4.2	8.2.5a)					
	– Operational performance at $U_e/I_e$	9.4.4.1	8.2.4.2b)					
	– Dielectric withstand verification	9.4.4.4	9.3.3.4					
– Temperature-rise verification	9.4.4.5	8.2.2	1	1 1)	1	Max.		
– Overload releases verification	9.4.4.6	8.2.1.5						
V 7)	– Additional breaking capacity	9.4.5.1	8.2.5b)				1	Max.
	– Dielectric withstand verification	9.4.5.3	9.3.3.4					
VI 8)	– Short-circuit breaking capacity	9.4.6.1	8.2.5c)				1	1
	– Dielectric withstand verification	9.4.6.3	9.3.3.4					
VII 9)	– Rated service short-circuit breaking capacity at $I_{cs}$	9.4.7.1	8.2.5a)				1	1
	– Dielectric withstand verification	9.4.7.3	9.3.3.4					
VIII 10)	EMC	9.4.8	8.3					

- 1) In the case of CPS's having line and load terminals not identified and having fixed or sealed trip units (see 8.1.7.4), and additional sample shall be tested with the connections reversed.
- 2) In the case of CPS's having line and load terminals not identified and having fixed or sealed trip units (see 8.1.7.4), one of the samples shall be tested with the connections reversed.
- 3) Over-current release settings if adjustable.
- 4) No. of sample if multiple rating of  $I_{cs}$ , related to  $U_e$ :  
No. 1  $U_e$  max / corresponding  $I_{cs}$   
No. 2  $I_{cs}$  max / corresponding  $U_e$   
No. 3 Intermediate values of  $U_e/I_{cs}$  corresponding  $I_{cs}$
- 5) In accordance with 9.3.2.1, rated values  $U_e/I_e$  may be assigned to some utilization categories without test or with a restricted number of tests and/or samples when tests of equivalent or higher severity have already been made.
- 6) In sequences I and II, the same sample may be used.
- 7) See 8.2.5; Test at  $U_e$  max.
- 8) Applicable to four-pole CPS's only.
- 9) Applicable to CPS's intended for use in an individual enclosure.
- 10) If applicable (8.3).

#### 9.4.1 Test Sequence I: Temperature-rise, operating limits, dielectric properties

- temperature-rise test (9.4.1.1)
- operation test (9.4.1.2)
- operating limits test (9.4.1.3)
- dielectric properties test (9.4.1.4)
- verification of main contact position for CPS suitable for isolation (9.4.1.5)

##### 9.4.1.1 Temperature-rise test

The temperature-rise test shall be made at the conventional thermal current according to 9.3.3.3. At the end of the test, the values of temperature-rise shall not exceed those specified in tables 5, 6 and 7.

##### 9.4.1.2 Operation test

Tests shall be made when the CPS is installed as specified in 9.3.2.1, in accordance with 8.2.1.1 for the following purposes:

- to verify tripping of the CPS with the closing device energized;
- to verify trip free operation of the CPS when the closing operation is initiated with the tripping device actuated;
- to verify that the operation of an external power-operated device when the CPS is already closed shall neither cause damage to the CPS nor endanger the operator;
- to verify that the operation of resetting shall not close the CPS in the absence of a closing command.

If the CPS is fitted with combined opening (stop) and reset actuating mechanisms, with the CPS closed, the resetting mechanism shall be operated and this shall cause the CPS to open.

If the CPS is fitted with either a reset or a stop-reset mechanism only or separate opening (stop) and reset actuating mechanisms, with the CPS closed and the resetting mechanism in the reset position, the tripping mechanism shall be operated and the CPS shall open.

NOTE These tests verify that the overload tripping action cannot be defeated by holding the reset mechanism in the reset position.

With the CPS loaded as for the temperature-rise test of the main circuit and the equilibrium temperature having been reached, the CPS shall be operated by its normal means three times in quick succession. The CPS shall not trip due to shock caused by the operation.

The mechanical operation of a CPS may be checked under no-load condition.

For a CPS with stored energy operation it shall be verified that the moving contacts cannot be moved from the open position when the operating mechanism is charged to slightly below the full charge, as evidenced by the indicating device.

If the closing and opening times of a CPS are stated by the manufacturer, such times shall comply with the stated values.

### 9.4.1.3 Operating limits tests

Tests shall be made as specified in 9.3.3.2.

#### 9.4.1.3.1 Power operated CPS's

CPS's shall be tested to verify their performance according to the requirements given in 8.2.1.2.

A CPS with dependent power operation shall be operated with operating mechanism charged to the minimum and maximum limits stated by the manufacturer.

#### 9.4.1.3.2 Relays or releases

##### a) Operation of shunt releases

Shunt releases shall be tested for compliance with the requirements of 8.2.1.4.

##### b) Operation of under-voltage relays or releases

Under voltage relays or releases shall be tested for compliance with the requirements of 8.2.1.3. Each limit shall be verified three times. For the drop-out test, the voltage shall be reduced from the rated value to zero at an uniform rate in approximatively 1 min.

##### c) Operation of over-current relays or releases

###### i) Opening under overload conditions

*Instantaneous or definite time-delay relays or releases (types a) and b) in 5.7.1.3.1)*

Operation shall be verified at 90 % and 110 % of the nominal tripping current of the relay or release. The test current shall have no asymmetry.

At a test current having a value equal to 90 % of the nominal value of the tripping current, the CPS shall not trip, the current being maintained:

- for 0,2 s in the case of instantaneous relays or releases;
- for an interval of time equal to twice the time-delay stated by the manufacturer in the case of definite time delay relays or release.

At a test current having a value equal to 110 % of the nominal tripping current, the CPS shall trip:

- within 0,2 s in the case of instantaneous relays or releases;
- within an interval of time equal to twice the time-delay stated by the manufacturer in the case of definite time delay relays or releases.

The operation of multipole relays or releases shall be verified with all poles loaded simultaneously with the test current.

###### **A1** *Inverse time-delay relays or releases (type c) in 5.7.1.3.1)*

It shall be verified that relays and releases operate according to the requirements of 8.2.1.5.1 with all poles energized.

Moreover, the characteristics defined in 8.2.1.5.1.1 shall be verified by tests at  $-5\text{ }^{\circ}\text{C}$ ,  $+20\text{ }^{\circ}\text{C}$ ,  $+40\text{ }^{\circ}\text{C}$  and may be verified at minimum and maximum temperatures given by the manufacturer if larger. However, for relays or releases declared compensated for ambient temperature, in case of a temperature range declared by the manufacturer larger than those given in Figure 1, the characteristics at  $-5\text{ }^{\circ}\text{C}$  and/or  $+40\text{ }^{\circ}\text{C}$  need not be verified if, when tested at the declared minimum and maximum temperatures, the corresponding tripping current values are in compliance with the limits specified for  $-5\text{ }^{\circ}\text{C}$  and/or  $+40\text{ }^{\circ}\text{C}$  in Figure 1. **A1**

**A1)** For electronic overload relays or releases, the thermal memory test verification of 8.2.1.5.1.2 shall be carried out at +20 °C.

Three-pole thermal or electronic overload relays energized on two poles only shall be tested as stated in 8.2.1.5.1.1 on all combinations of poles and at the maximum and minimum current settings for relays with adjustable settings. **A1)**

ii) *Opening under short-circuit conditions*

*Instantaneous or definite time-delay relays or releases (items a) and b) in 5.7.1.3.2)*

a) The operation of over-current relays or releases intended for protection against short-circuits shall be verified at 80 % and 120 % of the short circuit current setting of the relays or release. The test current shall have no asymmetry. At a test current having a value equal to 80 % of the short-circuit current setting, the CPS shall not trip, the current being maintained

- for 0,2 s in the case of instantaneous relays or releases;
- for an interval of time equal to twice the time-delay stated by the manufacturer, in the case of definite time-delay relays or releases.

At a test current having a value equal to 120 % of the short-circuit current setting, the CPS shall trip:

- within 0,2 s in the case of instantaneous relays or releases;
- within an interval of time equal to twice the time-delay stated by the manufacturer, in the case of definite time-delay relays or releases.

The operation of multipole opening relays or releases shall be verified with two poles in series using all possible combinations of poles having a short circuit release.

b) In addition, the operation of the short circuit releases, shall be verified individually on each pole at the value of the single pole tripping current published by the manufacturer; tripping shall occur:

- within 0,2 s in the case of instantaneous relays or releases;
- within an interval of time equal to twice the time-delay stated by the manufacturer, in the case of definite time-delay relays or releases.

iii) *Additional test for the time-delay of definite time-delay relays or releases (types b) in 5.7.1.3.1 and 5.7.1.3.2).*

*Opening time*

This test is made at a current value equal to 1,5 times the current setting:

- with all the poles loaded, in the case of overload relays or release (type b) in 5.7.1.3.1);
- with two poles in series using all possible combinations successively carrying the test current, in the case of short-circuit relays or releases (type b) in 5.7.1.3.2).

The opening time measured shall be between the limits of the time-delay stated by the manufacturer.

*Non-tripping duration*

This test is made under the same conditions as for the above test.

Firstly, the current is maintained for a time interval equal to the non-tripping duration stated by the manufacturer; then, the current is reduced to the rated current and maintained at this value for twice the nominal time-delay stated by the manufacturer. The CPS shall not trip.

**A1**) iv) *Under-current relays in automatic change-over*

The limits of operation shall be verified in accordance with 8.2.1.5.3.

v) *Stall relays*

The limits of operation shall be verified in accordance with 8.2.1.5.4.

For current sensing stall relays, the verification shall be made for the minimum and for the maximum set current values and for the minimum and maximum stall inhibit time (four settings).

For stall relays operating in conjunction with a rotation sensing mean, the verification shall be made for the minimum and maximum stall inhibit time. The sensor can be simulated by an appropriate signal on the sensor input of the stall relay.

vi) *Jam relays*

The limits of operation shall be verified in accordance with 8.2.1.5.5.

The verification shall be made for the minimum and for the maximum set current values and for the minimum and maximum jam inhibit time (four settings).

For each of the four settings, the test shall be made under the following conditions:

- apply a test current of 95 % of the set current value. The jam relay shall not trip;
- increase the test current to 120 % of the set current value. The jam relay shall trip according to the requirements given in 8.2.1.5.5. **A1**

#### 9.4.1.4 Dielectric properties test

The CPS shall be tested in accordance with 9.3.3.4.

#### 9.4.1.5 Verification of main contact position for CPS suitable for isolation

For CPS suitable for isolation, a test shall be made to verify the effectiveness of the indication of the main contact position in accordance with 8.2.5 of IEC 60947-1.

#### 9.4.2 Test Sequence II: Performance under normal load and overload conditions

- Rated making and breaking capacity test (9.4.2.1)
- Conventional operational performance test (9.4.2.2)
- Dielectric withstand verification (9.4.2.3)

##### 9.4.2.1 Rated making and breaking capacity test

The CPS shall be tested in accordance with 9.3.3.5.

###### 9.4.2.1.1 Rated making and breaking capacity for utilization categories other than AC-44 (e.g. direct-on-line and two direction CPS's)

Item 1 of 9.3.3.5.5 applies.

###### 9.4.2.1.2 Rated making and breaking capacity for utilization category AC-44 (e.g. direct-on-line and reversing CPS's)

Item 2 of 9.3.3.5.5 applies.

###### 9.4.2.1.3 Behaviour of the CPS during and condition after the making and breaking, change-over and reversing tests

The conditions of 9.3.3.5.6 shall be met.



#### 9.4.2.2 Conventional operational performance test

The CPS shall be tested in accordance with 9.3.3.6.

##### 9.4.2.2.1 Conventional operational performance for utilization categories other than AC-44 (e.g. direct-on-line and two direction CPS's)

The CPS shall make and break the currents corresponding to its utilization category and for the number of operations given in table 11.

##### 9.4.2.2.2 Conventional operational performance for utilization category AC-44 (e.g. direct-on-line and reversing CPS's)

- The CPS shall make and break the currents corresponding to its utilization category and for the number of operations given in table 11.
- For reversing CPS's, each sequence shall be:

Close A – open A – close B – open B – OFF period

The change-over from "open A" to "close B" shall be made as fast as the normal control system will allow.

##### 9.4.2.2.3 Behaviour of the CPS during and after the conventional operational performance tests

The conditions of 9.3.3.5.6 shall be fulfilled.

#### 9.4.2.3 Dielectric withstand verification

The dielectric withstand shall be verified in accordance with 9.3.3.4.

For CPS suitable for isolation, the leakage current shall be measured in accordance with 9.3.3.4.1 except that the leakage current shall not exceed 2 mA.

#### 9.4.3 Test sequence III: Operational performance before and after operating sequences at $I_{cr}$ and "r" current test

Test on the first sample:

- Operational performance test at  $U_e/I_e$  (9.4.3.1)
- Rated breaking capacity at short-circuit current  $I_{cr}$ , with the operating sequence O - t - CO - t - CO - t - O - t - rCO - t - rCO
- Operational performance test at  $U_e/I_e$  (9.4.3.1)
- Dielectric withstand verification (9.4.3.4)
- Overload releases verification (9.4.3.5).

Test on the second sample:

- Rated breaking capacity at short-circuit current "r" with the operating sequence O - t - CO - t - rCO
- Dielectric withstand verification (9.4.3.4)
- Overload releases verification (9.4.3.5).

NOTE With the agreement of the manufacturer the tests may be made on one sample.

#### 9.4.3.1 Operational performance test

Before and after the  $I_{cr}$  test on the first sample, the CPS shall be tested in accordance with 8.2.4.2 b) and 9.3.3.6.

#### 9.4.3.2 Test at prospective conventional current $I_{cr}$ and $I_r$

A short-circuit test is made under the general conditions of 9.3.4 with the values of prospective currents  $I_{cr}$  and  $I_r$  in accordance with 8.2.5 a).

The operating sequence shall be according to 9.4.3.

#### 9.4.3.3 Behaviour of the CPS during and after the tests at $I_{cr}$ and $I_r$

Subclause 9.3.4.1.7 applies.

#### 9.4.3.4 Dielectric withstand verification

The dielectric withstand shall be verified according to 9.4.2.3.

#### 9.4.3.5 Overload releases verification

Following the test of 9.4.3.4, the operation of overload releases (types a), b), c) in 5.7.1.3.1) shall be verified at the reference temperature and at any convenient voltage:

- at 1,2 times the values of their current setting for utilization categories AC-42, AC-43, AC-44, DC-43, DC-45;
- at 1,45 times the values of their current setting for utilization categories AC-40, AC-41, AC-45a, AC-45b, DC-40, DC-41, DC-46.

For this test, all poles shall be connected in series. Alternatively, this test may be made using a 3-phase supply.

Tripping shall occur within 2 h.

### 9.4.4 Test Sequence IV: Operational performance before and after operating sequences at $I_{cs}$

- Operational performance test (9.4.4.1)
- Test at short-circuit current  $I_{cs}$  (9.4.4.2)
- Dielectric withstand verification (9.4.4.4)
- Temperature rise verification (9.4.4.5)
- Overload releases verification (9.4.4.6).

#### 9.4.4.1 Operational performance test

Before and after the test of 9.4.4.2, the CPS shall be tested in accordance 9.3.3.6 with test parameters given in table 12.

#### 9.4.4.2 Rated service short-circuit breaking capacity test at $I_{cs}$

A short-circuit test is made under the general conditions of 9.3.4 with a value of prospective current  $I_{cs}$  (see 5.3.6.1), as declared by the manufacturer.

The power-factor for this test shall be according to table 16 of Part 1.

The operating sequence shall be: O-t-CO-t-rCO (see 9.3.4.1.6).

NOTE In the USA and Canada, minimum values of service short-circuit breaking capacity ( $I_{CS}$ ) are specified and an additional test sequence is required to verify the single pole interrupting capability of multi-pole CPS's corresponding to the minimum specified value of the short-circuit breaking capacity and the corresponding phase-to-phase voltage for CPS's marked with phase-to-phase voltage only or phase-to neutral voltage for CPS's marked with phase-neutral/phase-phase voltage.

#### 9.4.4.3 Behaviour of the CPS during and after the test at $I_{CS}$

Subclause 9.3.4.1.7 applies.

#### 9.4.4.4 Dielectric withstand verification

The dielectric withstand shall be verified according to sub clause 9.4.2.3.

#### 9.4.4.5 Temperature-rise verification

The temperature-rise at the terminals shall be verified at the rated operational current corresponding to the utilization category according to 9.3.3.3.1 to 9.3.3.3.4. The temperature-rise shall not exceed the values given in table 5.

#### 9.4.4.6 Overload releases verification

Following the test, of 9.4.4.5, the operation of overload releases shall be verified in accordance with 9.4.3.5.

### 9.4.5 Test Sequence V: Additional breaking capacity

- Additional breaking capacity test (9.4.5.1)
- Dielectric withstand verification (9.4.5.3)

#### 9.4.5.1 Additional breaking capacity test

The CPS shall break the test current stated in 8.2.5b) at the rated operational voltage  $U_e$  and the power factor or time constant according to table 16 of Part 1.

The operating sequence shall be O-t-O-t-O.

#### 9.4.5.2 Behaviour of the CPS during and after the additional breaking capacity test

The requirements of 9.3.3.5.6 shall be met.

#### 9.4.5.3 Dielectric withstand verification

The electric withstand shall be verified according to 9.4.2.3.

### 9.4.6 Test Sequence VI: Additional test sequence for four-pole CPS's

- Short-circuit breaking capacity test (9.4.6.1)
- Dielectric withstand verification (9.4.6.3).

#### 9.4.6.1 Short-circuit breaking capacity test

Four pole CPS having a fourth pole of reduced short-circuit rating shall pass the additional test of 9.3.4.1.6, item b).

The operating sequence shall be O-t-CO-t-rCO.

#### 9.4.6.2 Behaviour of the CPS during and after the short circuit breaking capacity test

Subclause 9.3.4.1.7 applies.

#### 9.4.6.3 Dielectric withstand verification

The dielectric withstand shall be verified according to 9.4.2.3.

#### 9.4.7 Test Sequence VII: Additional test sequence for CPS's intended for use in an individual enclosure

- Rated service short-circuit breaking capacity test at  $I_{CS}$  (9.4.7.1)
- Dielectric withstand verification (9.4.7.3)

##### 9.4.7.1 Rated service short-circuit breaking capacity test at $I_{CS}$

CPS intended for use in an individual enclosure shall pass the additional test of 9.3.4.1.1 in the smallest individual enclosure stated by the manufacturer at the rated operational voltage  $U_e$  and the power-factor or time constant according to table 16 of Part 1.

The test current shall be equal to the rated service short-circuit breaking capacity  $I_{CS}$  of the CPS corresponding to  $U_e$  max.

The operating sequence shall be O-t-CO-t-rCO.

##### 9.4.7.2 Behaviour of the CPS during the rated service short circuit breaking capacity test at $I_{CS}$

Subclause 9.3.4.1.7 applies.

##### 9.4.7.3 Dielectric withstand verification

The dielectric withstand shall be verified according to 9.4.2.3.

#### 9.4.8 Test sequence VIII: EMC

The CPS shall be tested in accordance with 9.3.5.

### 9.5 Routine tests

#### 9.5.1 General

Routine tests shall be carried out under conditions the same as, or equivalent to those specified for type tests in the relevant parts of 9.1.2. However the limits of operation in 9.4.1.3 may be verified at the prevailing ambient air temperature.

#### 9.5.2 Operation and operating limits

Tests are carried out to verify operation within the limits specified in 8.2.1.

NOTE In these tests it is not necessary to reach thermal equilibrium.

The lack of thermal equilibrium may be compensated by using a series resistor or by appropriately decreasing the voltage limit.

**A1** Tests shall be made to verify the calibration of relays or releases. In the case of a time delay overload relay or release, this may be a single test with all poles equally energized at a multiple of the current setting, to check that the tripping time conforms (within tolerances) to the curves supplied by the manufacturer; in the case of an instantaneous overload relay or release, the test shall be carried out at 1,1 times the current setting. For under-current relays, stall relays and jam relays, tests shall be carried out to verify the proper operation of these relays (see 8.2.1.5.3, 8.2.1.5.4 and 8.2.1.5.5). **A1**

NOTE In the case of a time-delay overload relay or release comprising a time delay device working with a fluid dashpot, calibration may be carried out with the dashpot empty at a percentage of the current setting indicated by the manufacturer and capable of being verified by a special test.

### 9.5.3 Dielectric tests

The dielectric withstand shall be verified in accordance with 9.3.3.4.

**A1** Subclause deleted **A1**

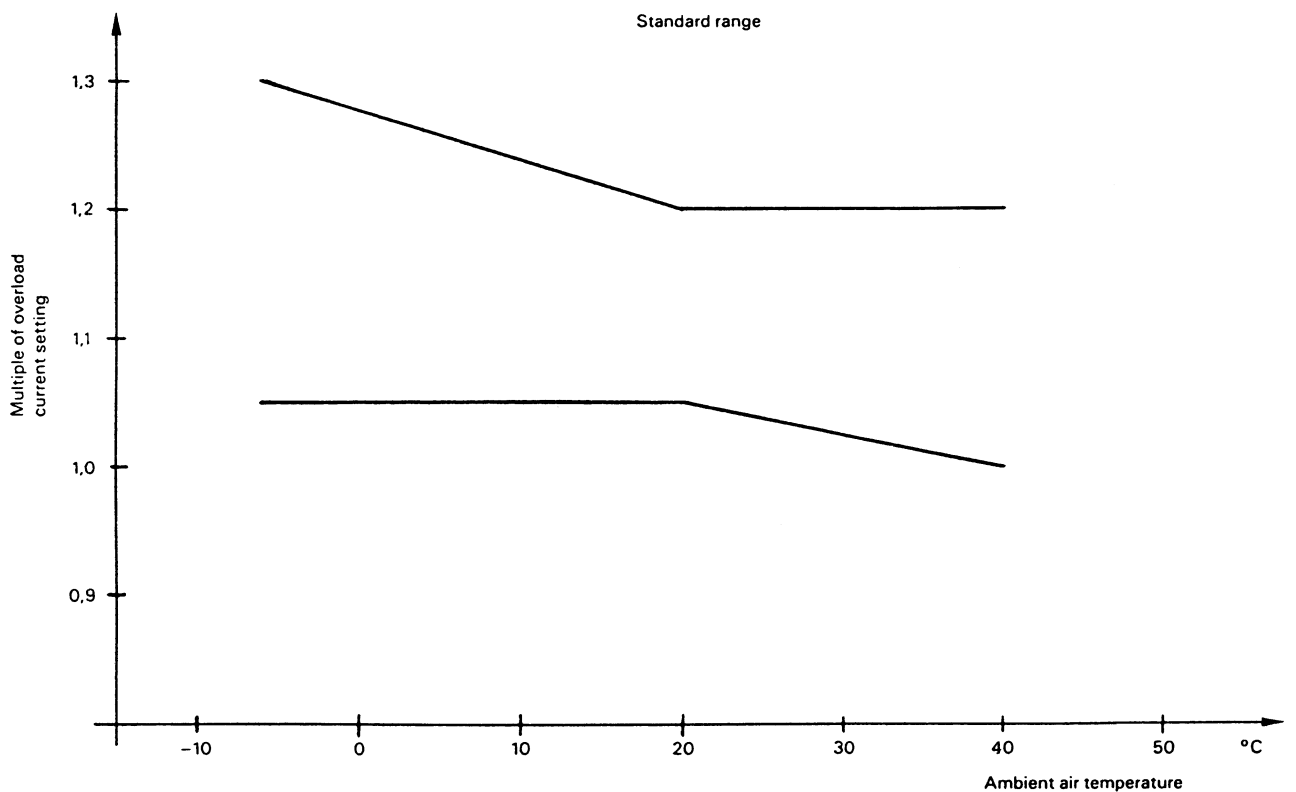

IEC 2379/02

**Figure 1 – Multiple of current setting limits for ambient air temperature time-delay overload relays or releases (see 8.2.1.5.1)**

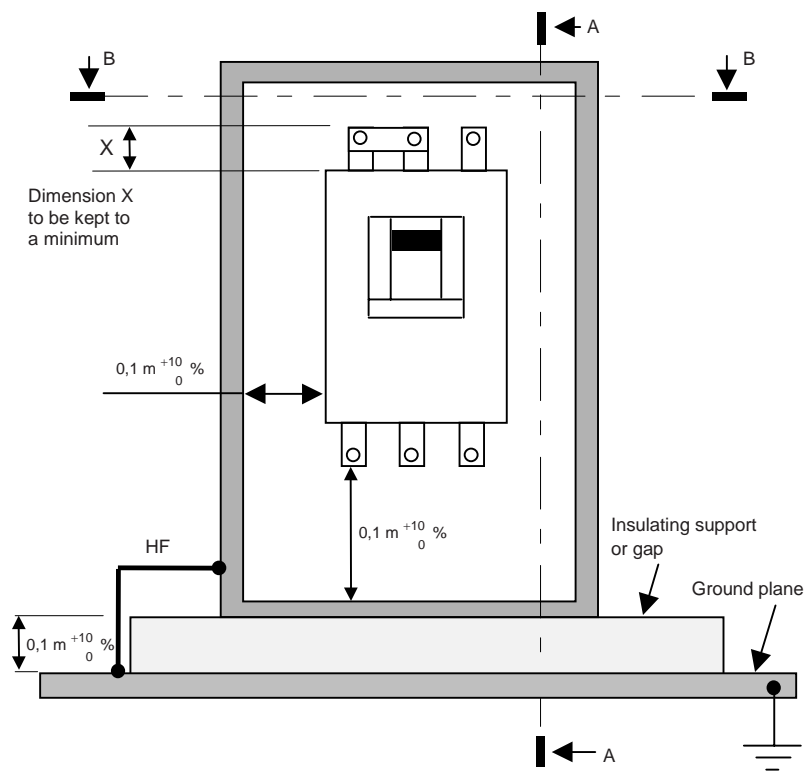
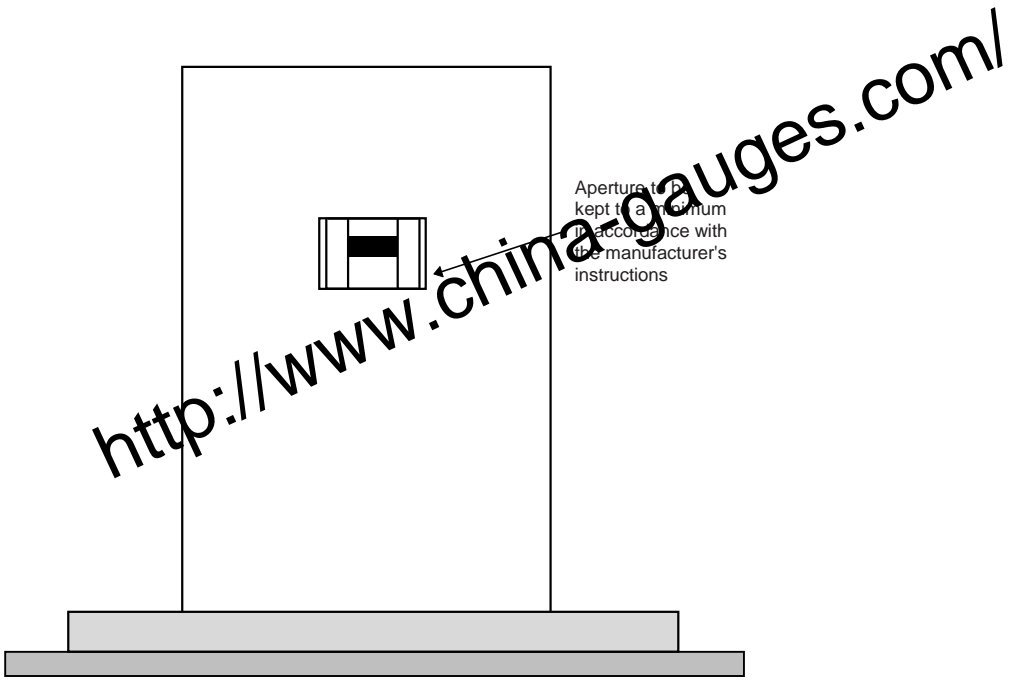

IEC 2380/02

Figure 2a – Elevation

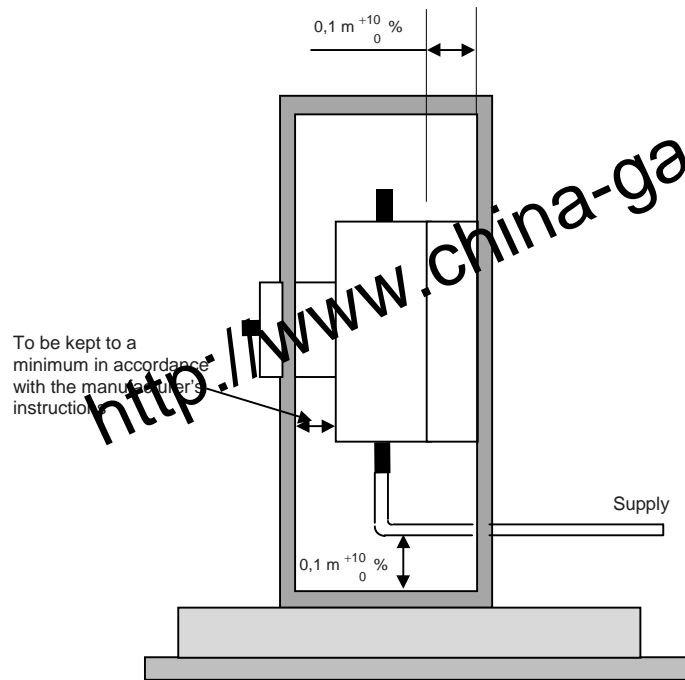

Section A-A

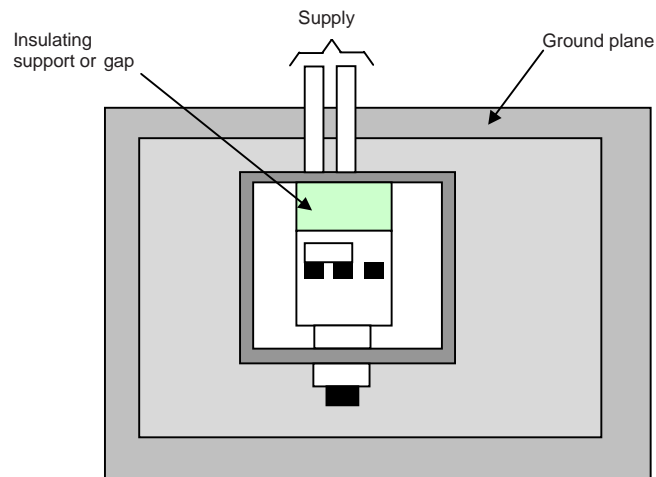

Section B-B

IEC 2381/02

Figure 2b – Sections A-A and B-B

Figure 2 – EUT mounted in metallic enclosure –  
Two-phase poles in series configuration

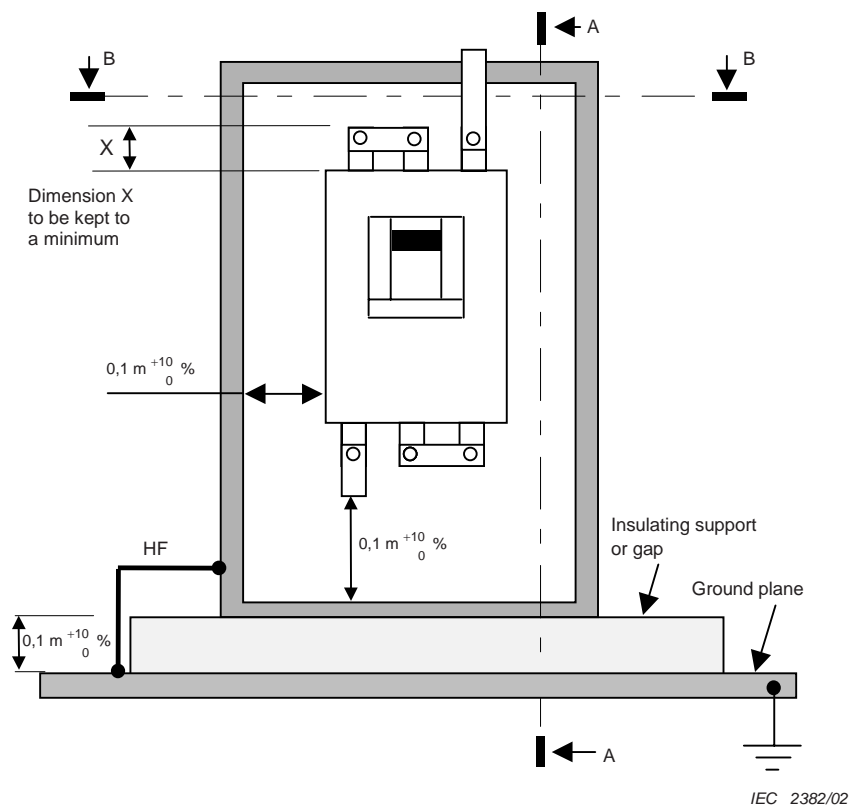
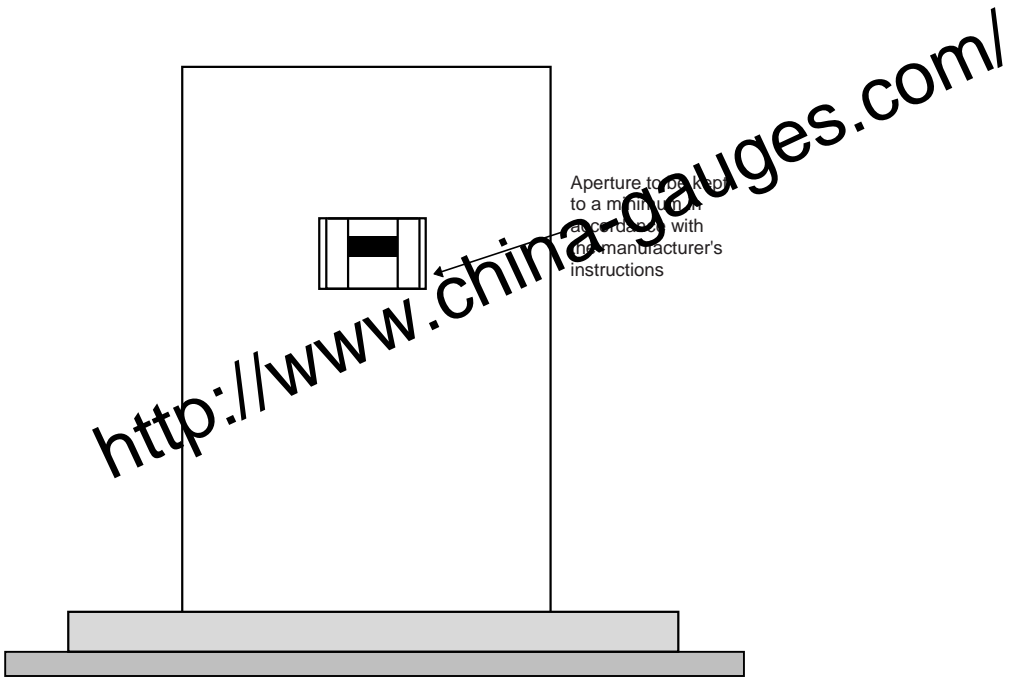
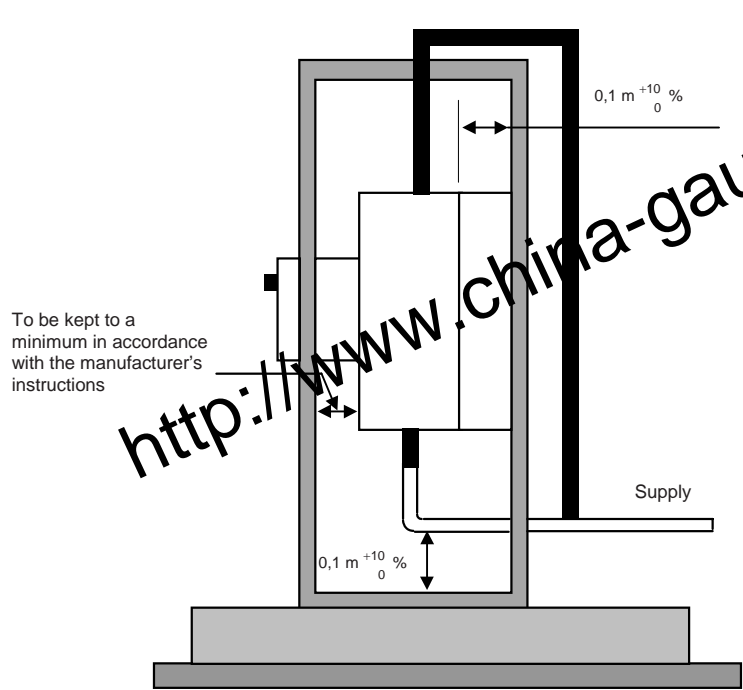
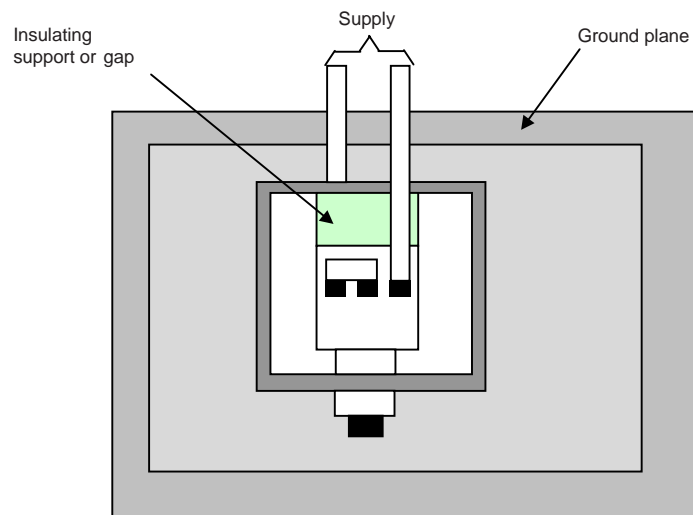

Figure 3a – Elevation





Section A-A



Section B-B

IEC 2383/02

Figure 3b – Sections A-A and B-B

Figure 3 – EUT mounted in metallic enclosure –  
Three-phase poles in series configuration

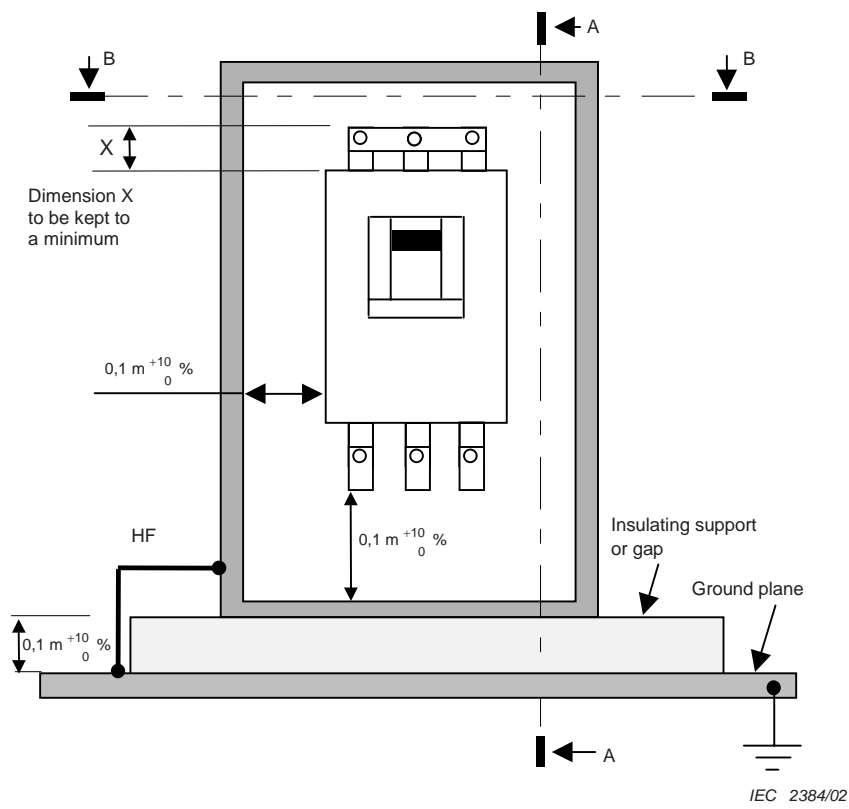
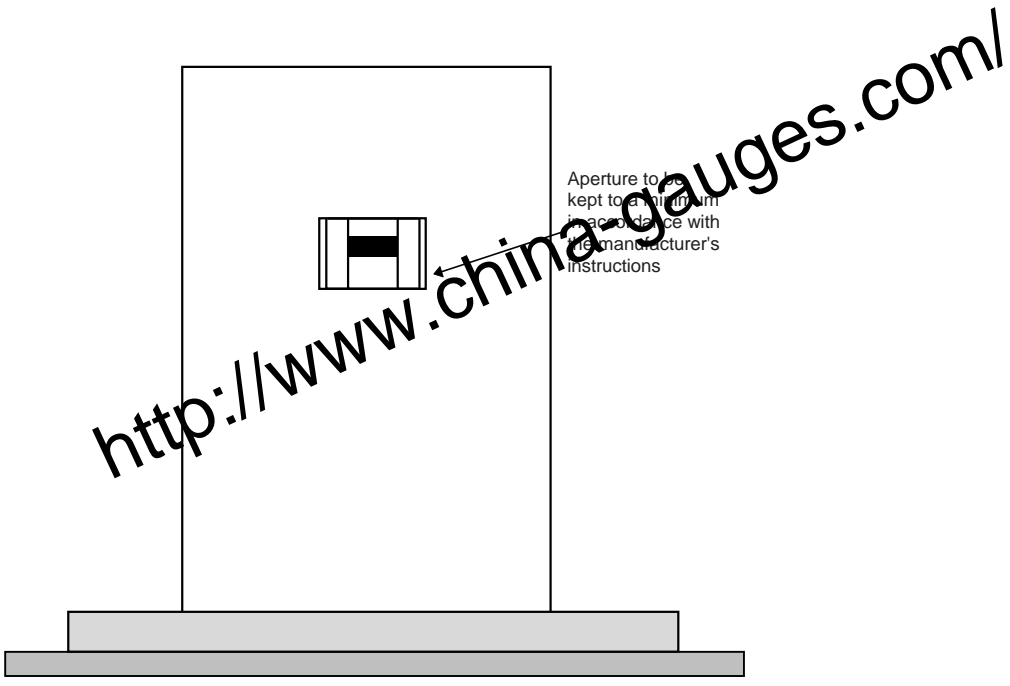
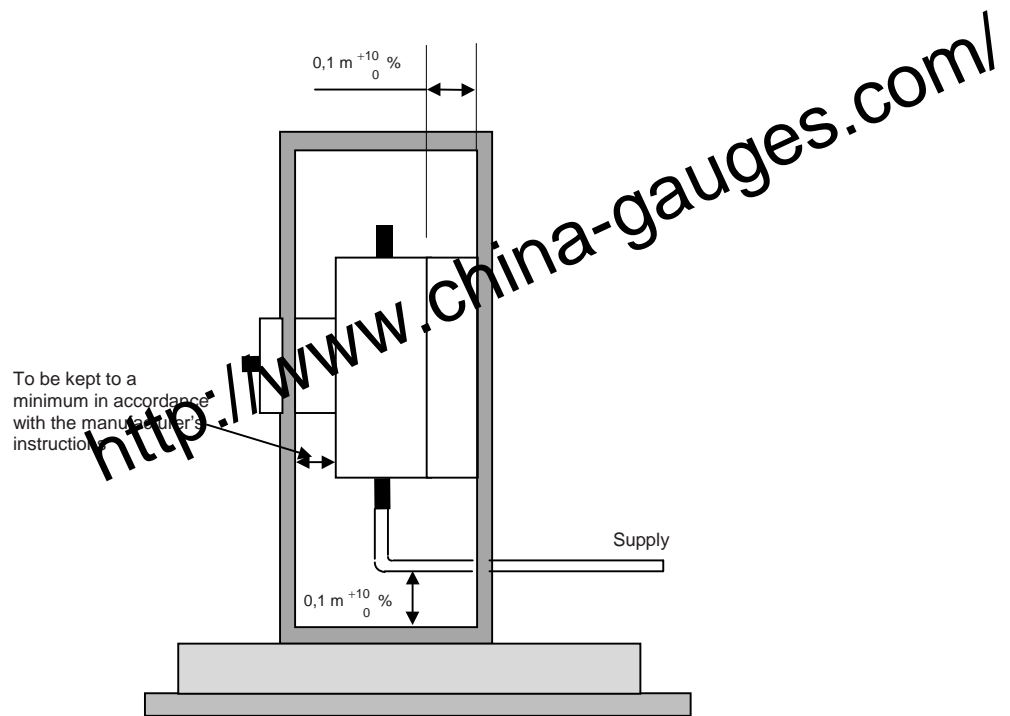
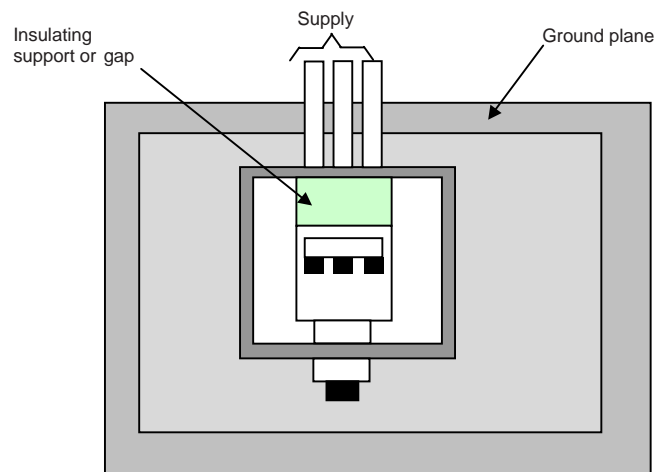

Figure 4a – Elevation



Section A-A



Section B-B

IEC 2385/02

Figure 4b – Sections A-A and B-B

Figure 4 – EUT mounted in metallic enclosure –  
Three-phase configuration

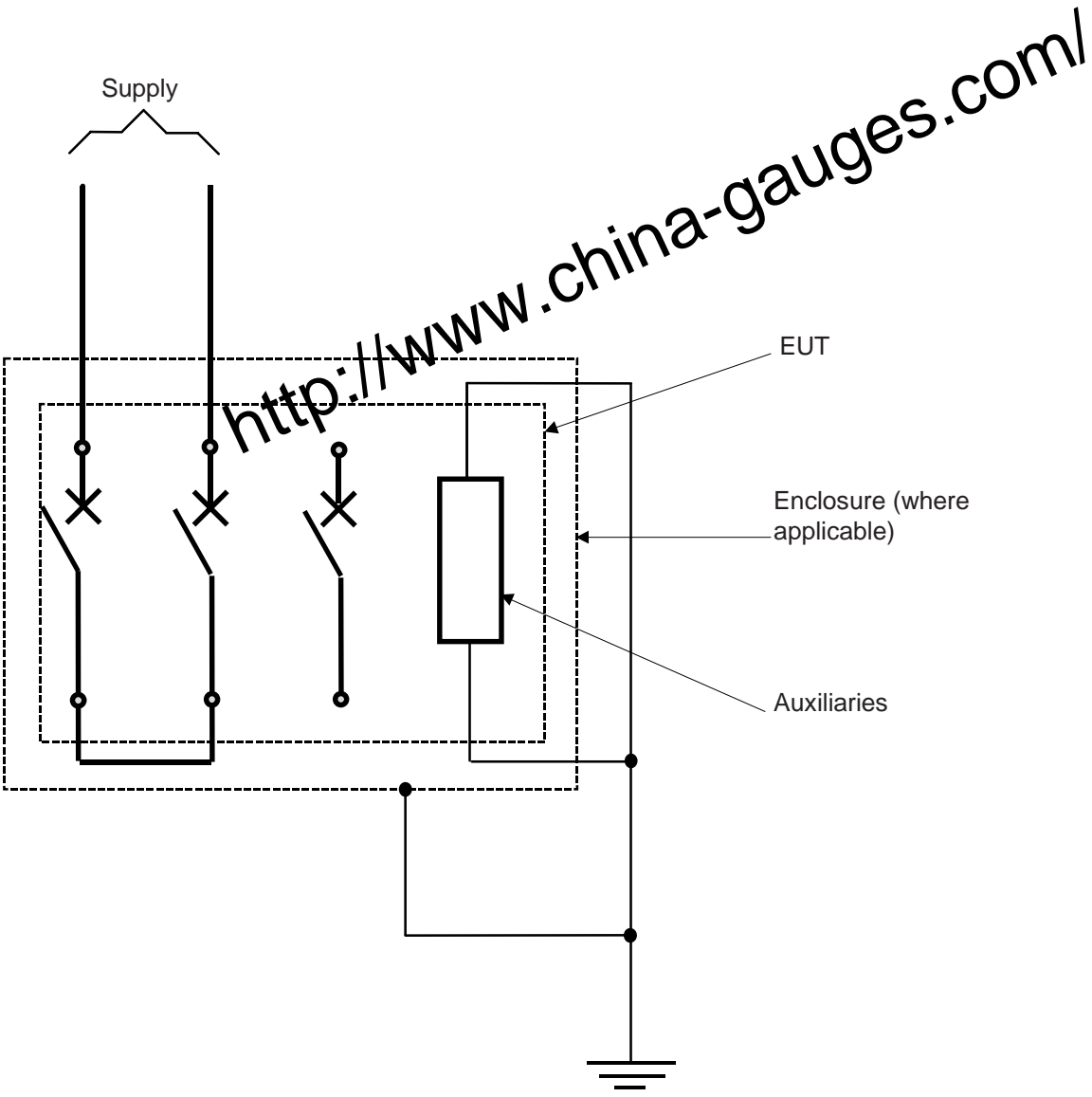

IEC 2386/02

**Figure 5 – Test circuit for emission tests, immunity to harmonics, current dips, electrostatic discharges and radiated electromagnetic fields – Two-phase poles in series configuration**

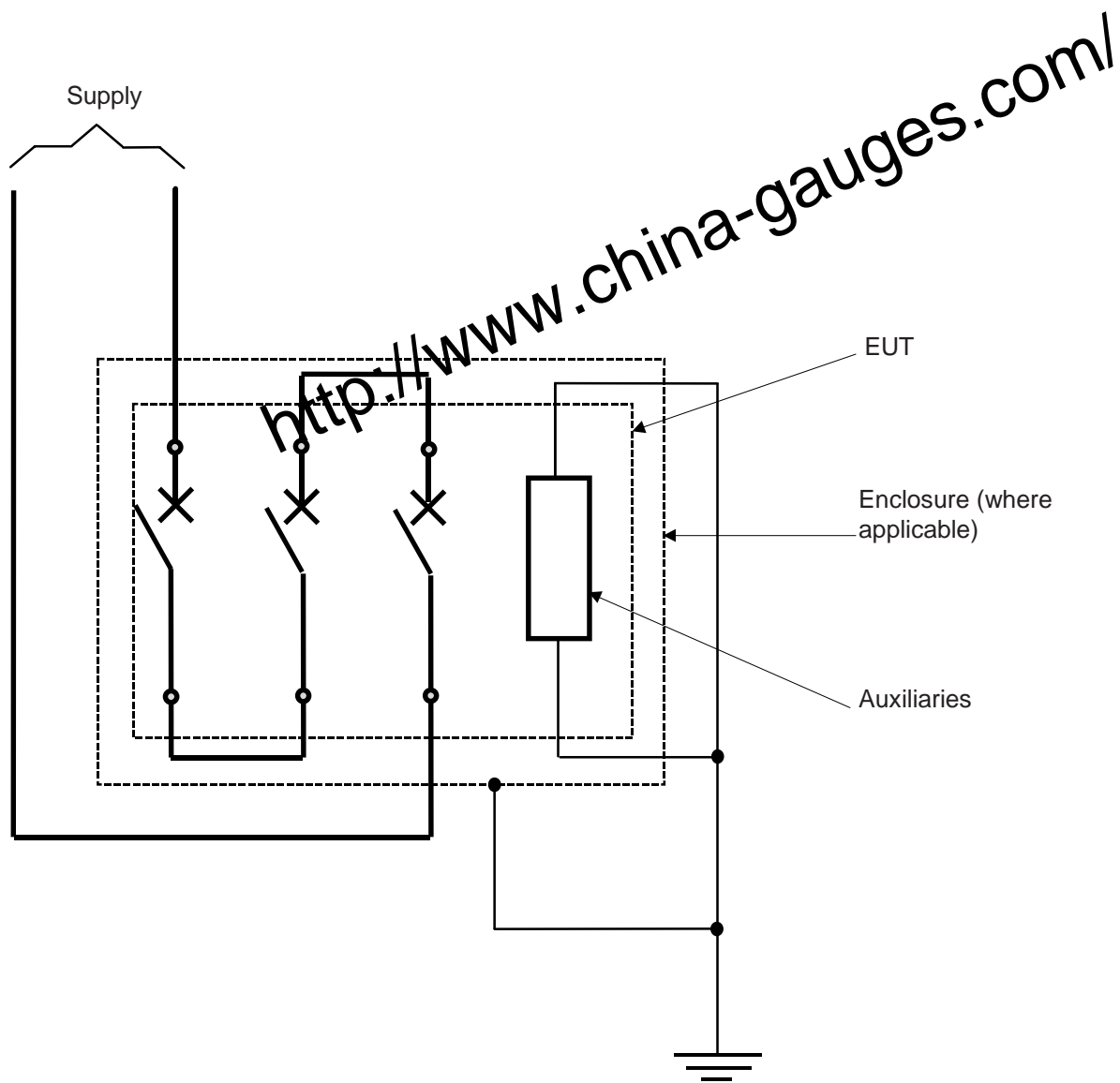

IEC 2387/02

**Figure 6 – Test circuit for emission tests, immunity to harmonics, current dips, electrostatic discharges and radiated electromagnetic fields – Three-phase poles in series configuration**

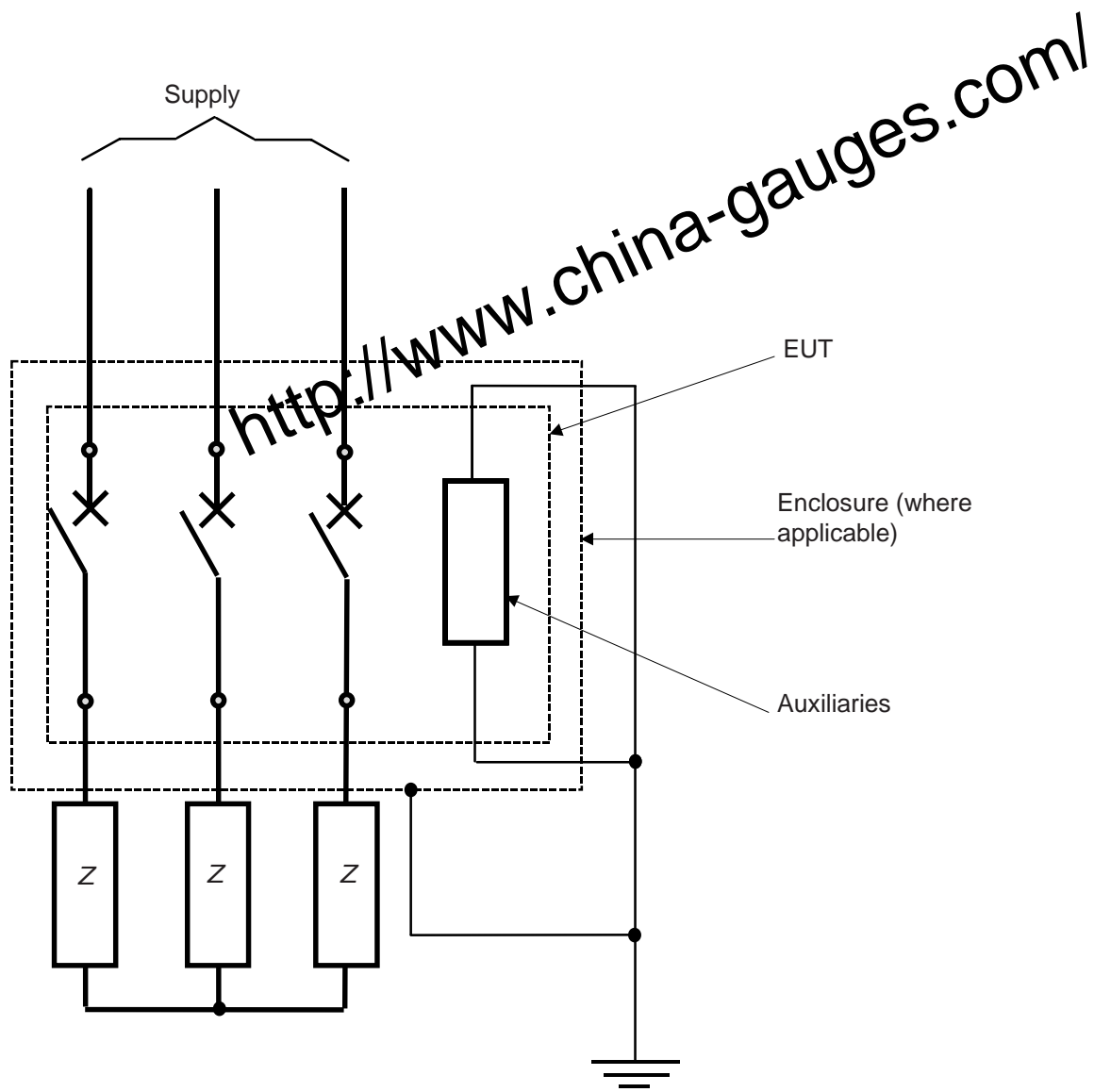

IEC 2388/02

**Key**

Z impedance for adjusting the current (where required)

**Figure 7 – Test circuit for emission tests, immunity to harmonics, current dips, electrostatic discharges and radiated electromagnetic fields – Three-phase configuration**

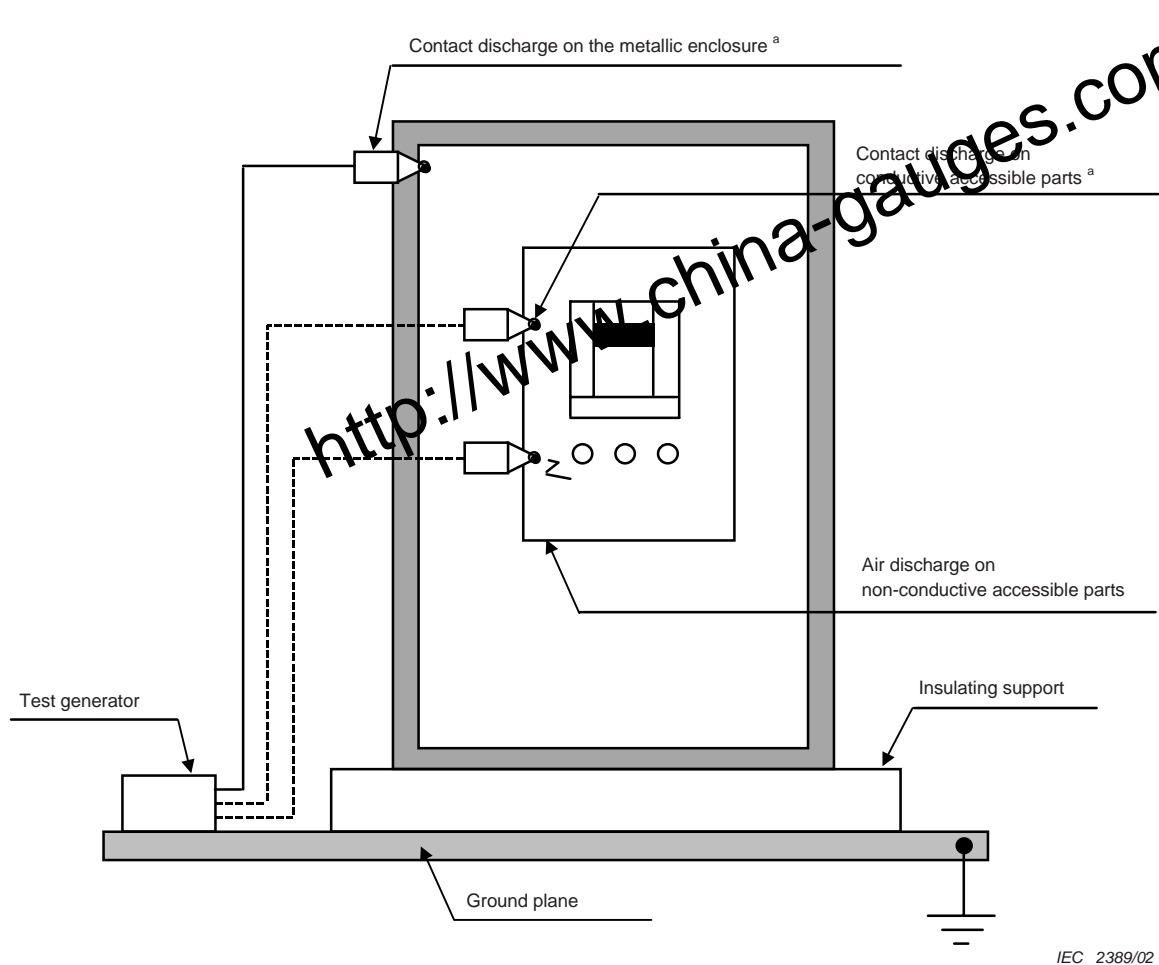

<sup>a</sup> Contact discharge probe shall be applied perpendicular to the surface under test.

**Figure 8 – Test set-up for the verification of immunity to electrostatic discharges**

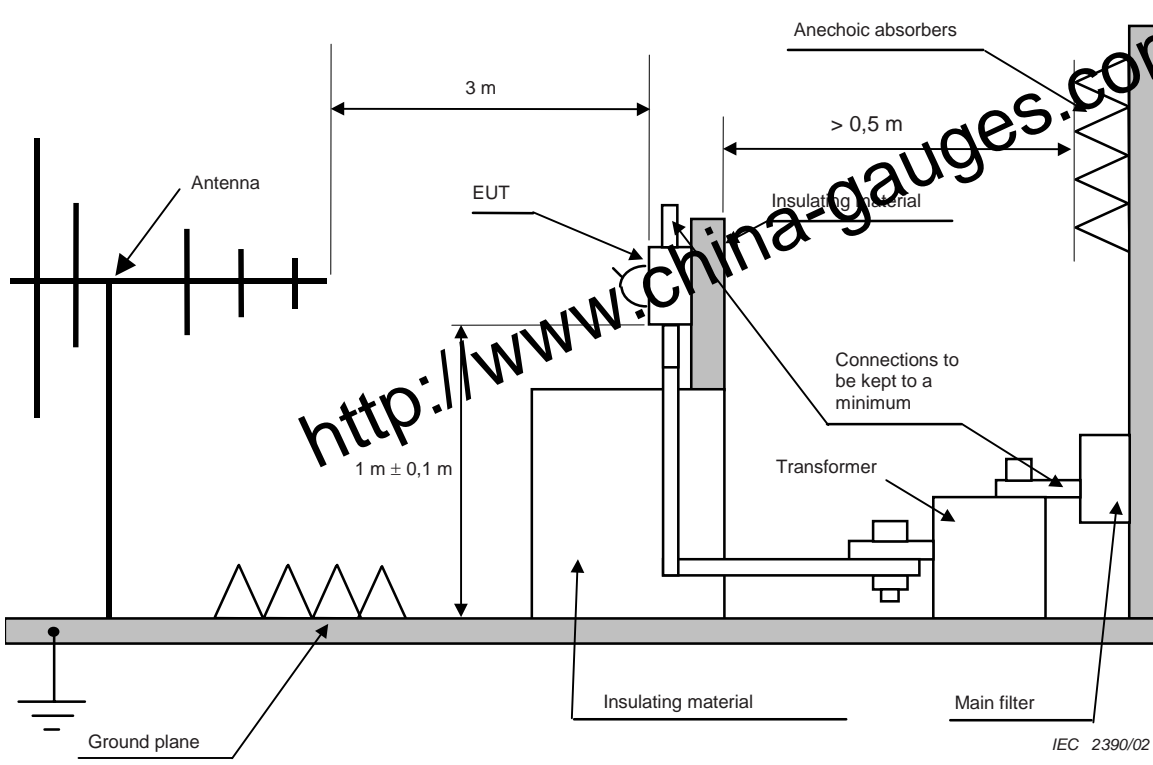
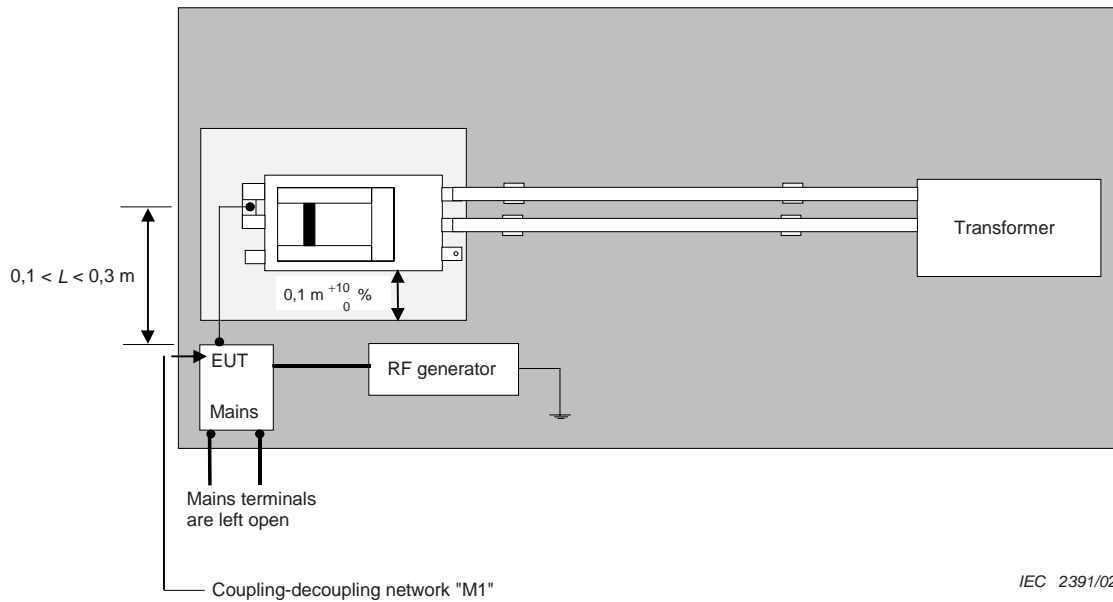
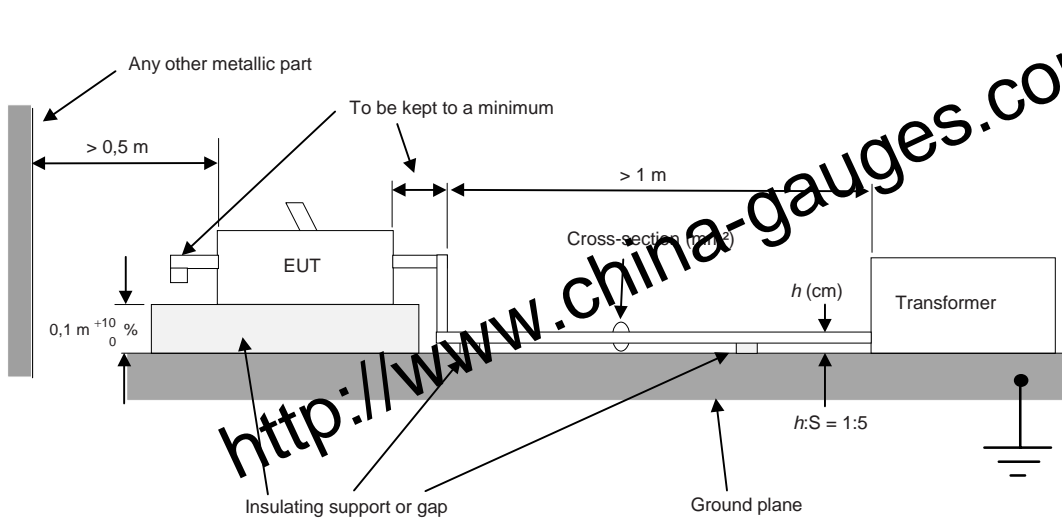

Figure 9 – Test set-up for immunity to radiated electromagnetic fields





**Key**

$L$  total cable length

NOTE As an alternative to the coupling-decoupling network M1, M2 or M3 may be used in which case the two or three connecting wires, as applicable, are connected to the same point of the EUT.

**Figure 10 – Test set-up for conducted disturbances induced by radio-frequency fields (common mode) – Two-phase poles in series configuration**

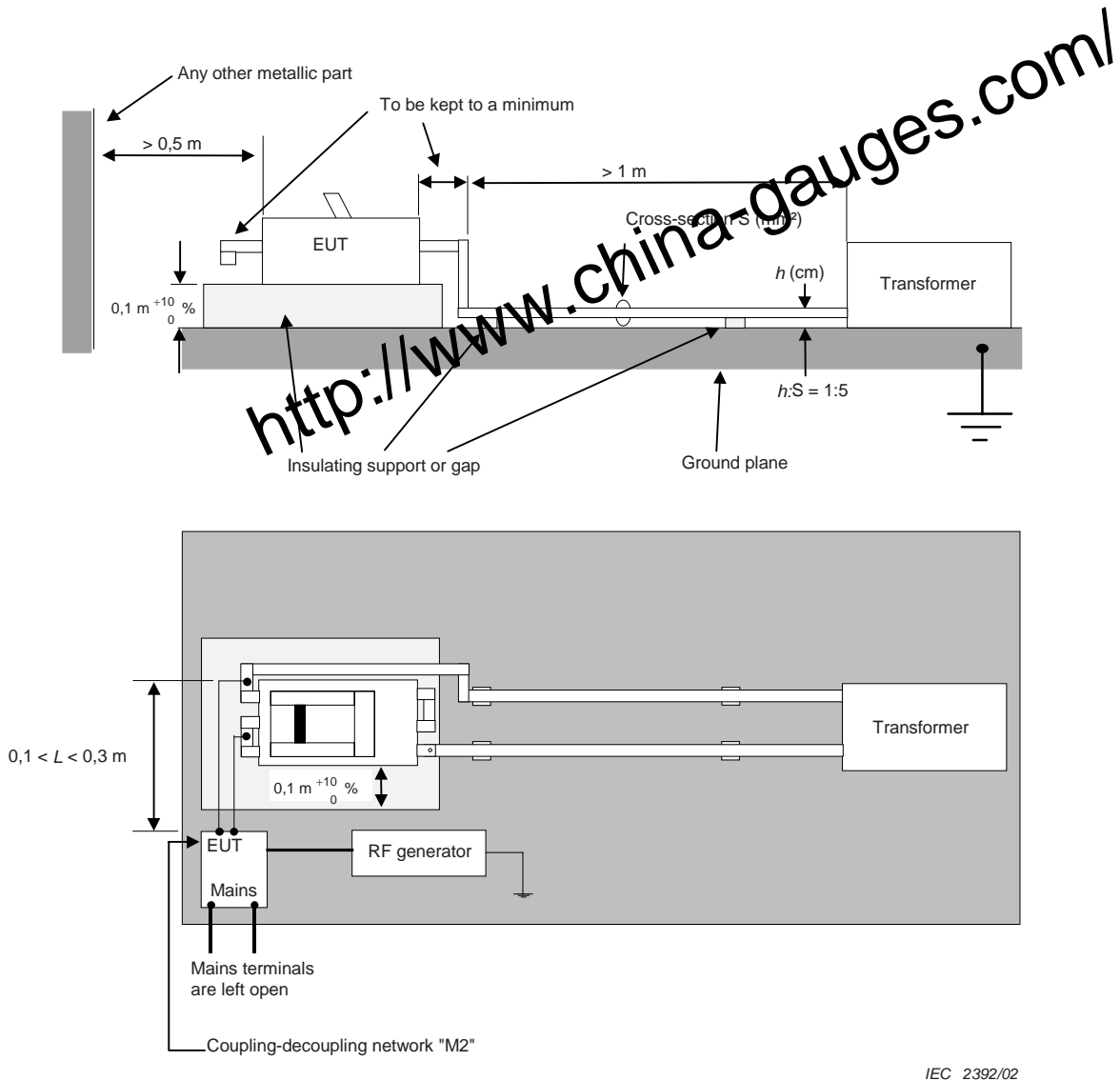

IEC 2392/02

**Key**

$L$  total cable length

**Figure 11 – Test set-up for conducted disturbances induced by radio-frequency fields (common mode) – Three-phase poles in series configuration**

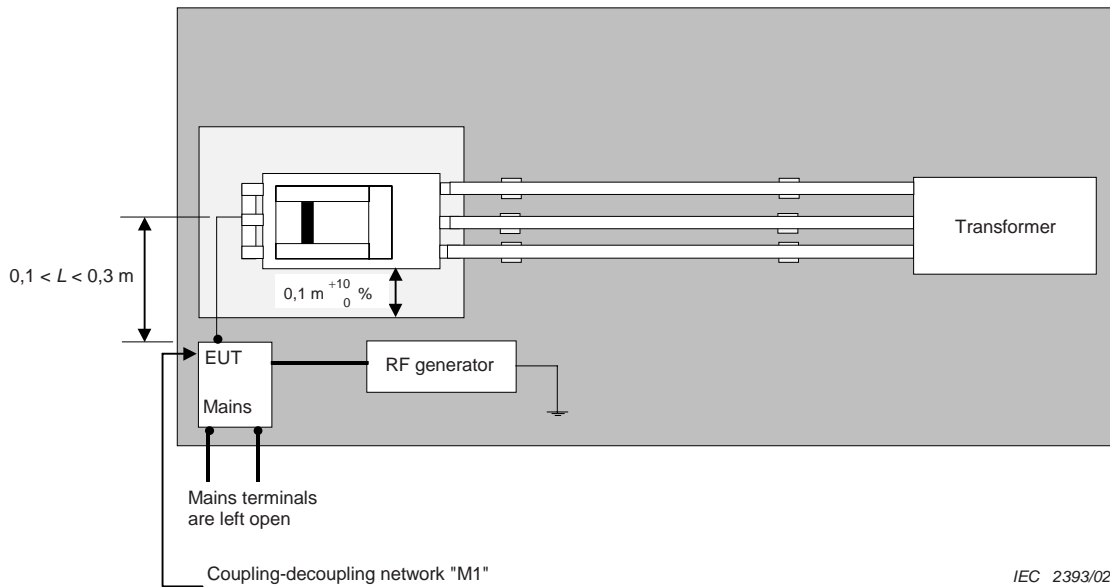
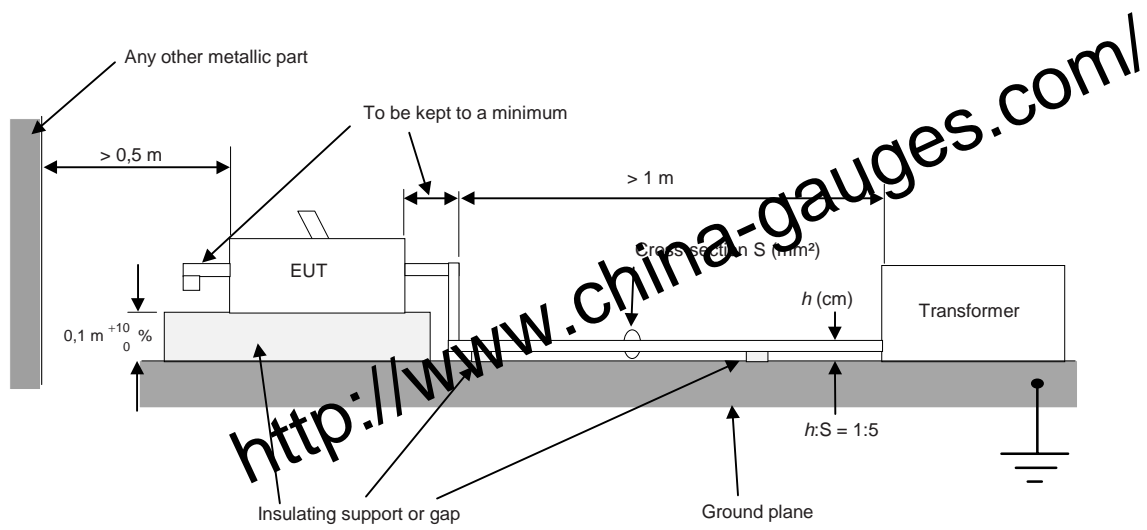

**Key**

L total cable length

NOTE As an alternative to the coupling-decoupling network M1, M2 or M3 may be used, in which case the two or three connecting wires, as applicable, are connected to the same point of the EUT.

**Figure 12 – Test set-up for conducted disturbances induced by radio-frequency fields (common mode) – Three-phase configuration**

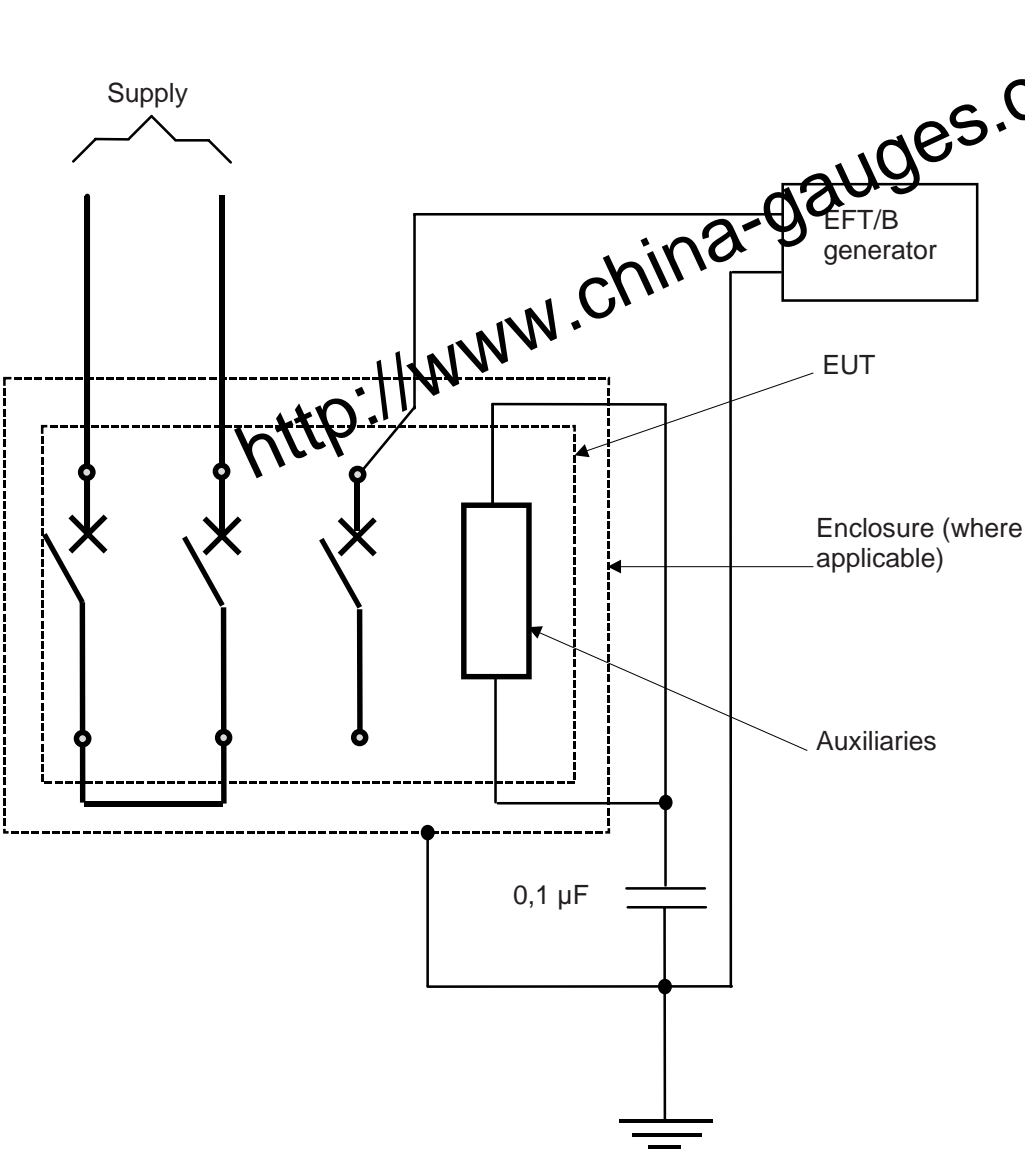

IEC 2394/02

Figure 13 – Circuit for electrical fast transients/bursts (EFT/B) immunity test – Two-phase poles in series configuration

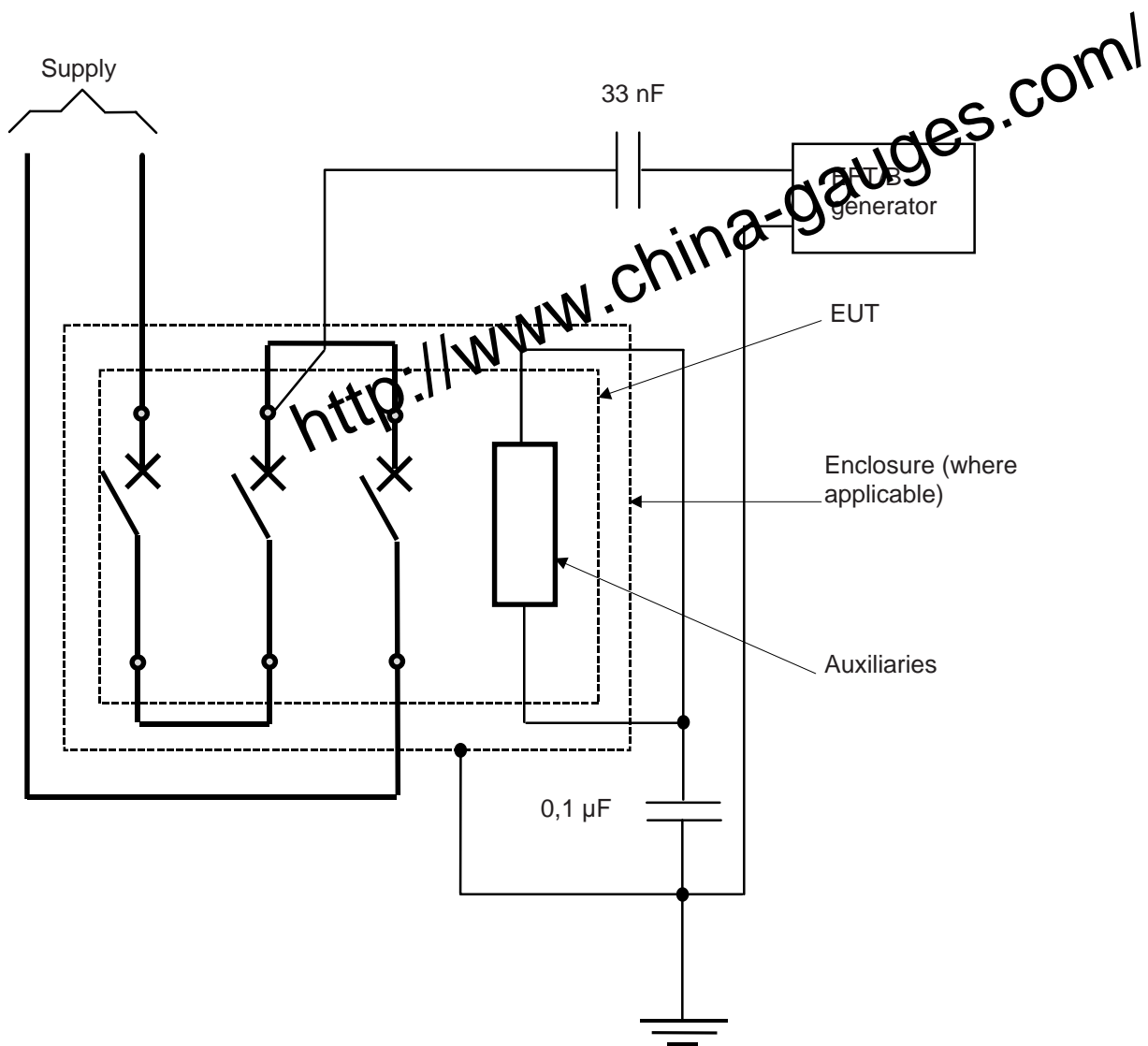

IEC 2395/02

Figure 14 – Circuit for electrical fast transients/bursts (EFT/B) immunity test – Three-phase poles in series configuration

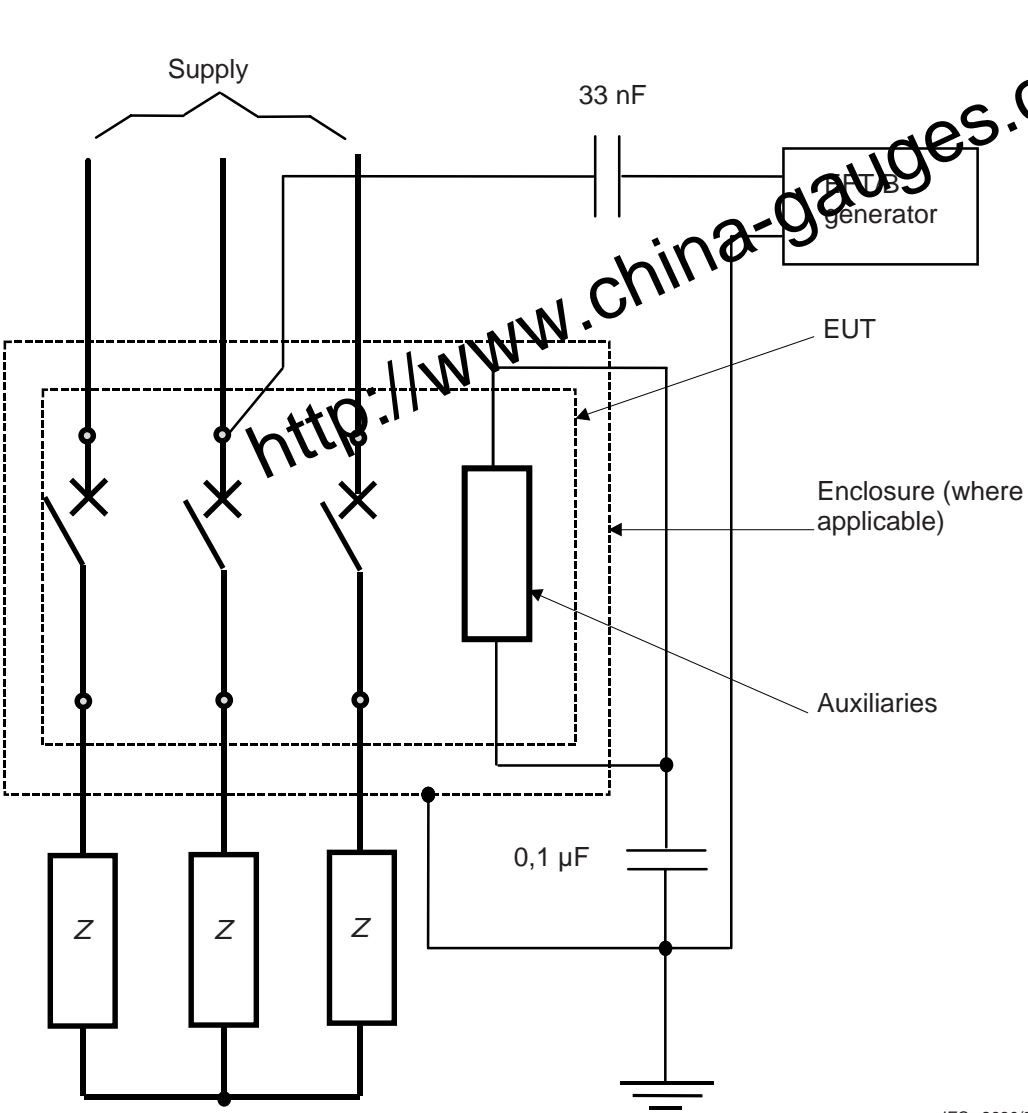

IEC 2396/02

**Key**

Z impedance for adjusting the current (where required)

**Figure 15 – Circuit for electrical fast transients/bursts (EFT/B) immunity test – Three-phase configuration**

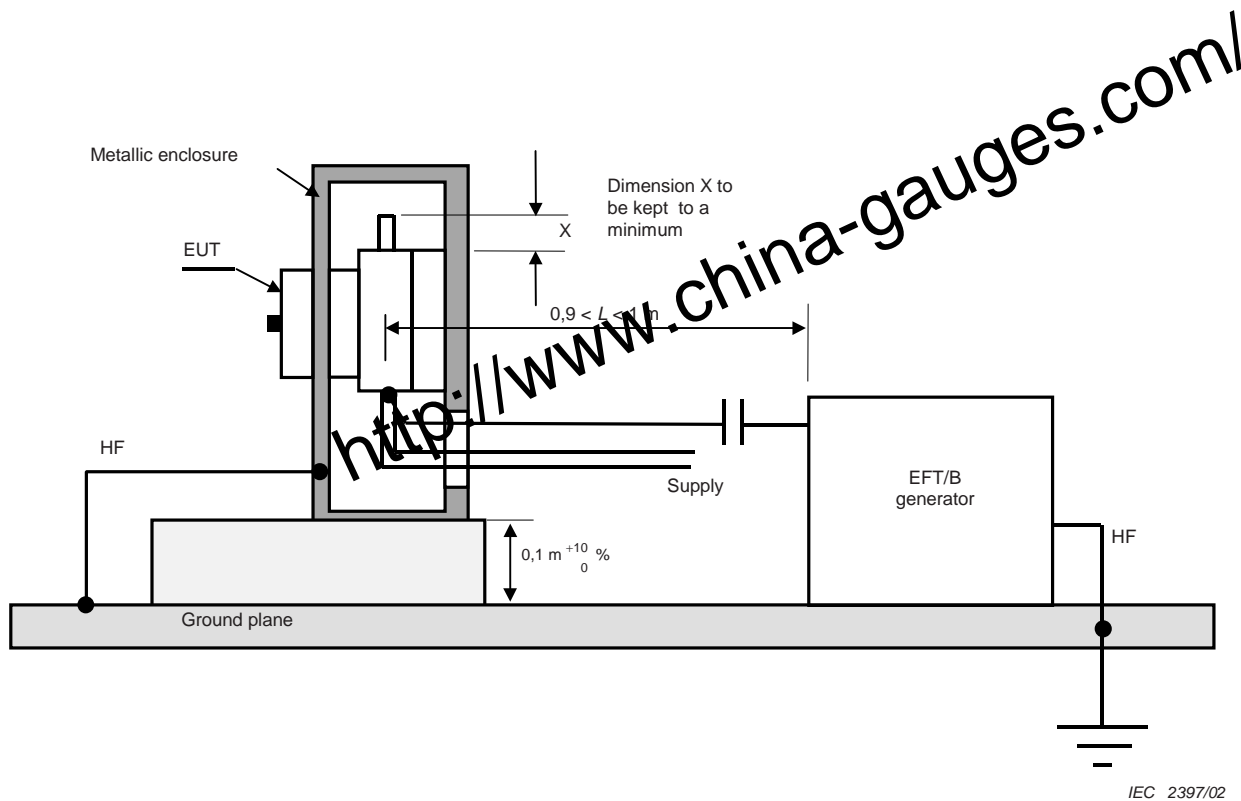

**Key**

$L$  total cable length

NOTE This is a representative example; other test set-ups may be used providing the requirements for the tests are complied with.

**Figure 16 – Test set-up for electrical fast transients/bursts (EFT/B) immunity test**

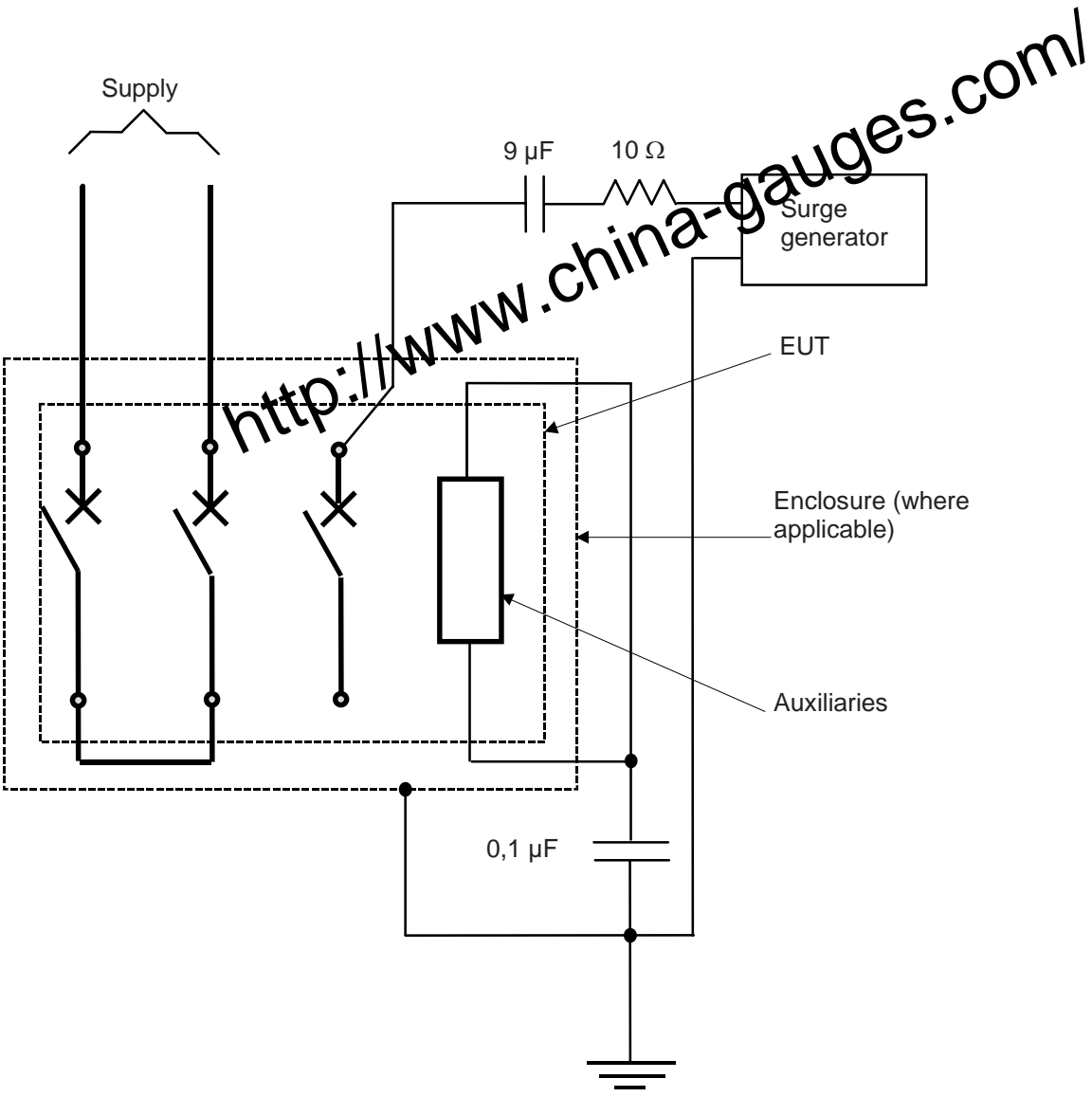

IEC 2398/02

Figure 17 – Test circuit for the verification of the influence of surges in the main circuit (line-to-earth) – Two-phase poles configuration



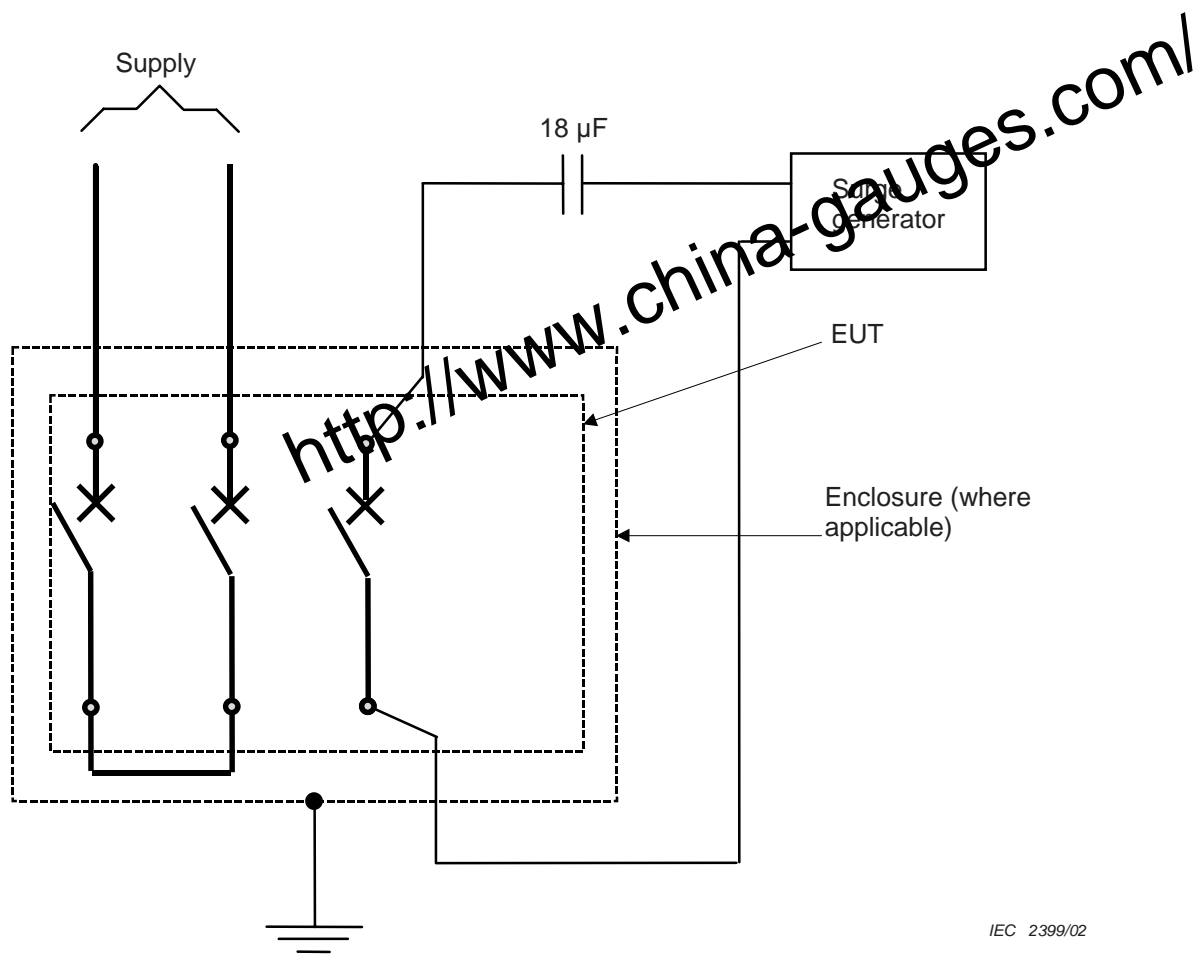
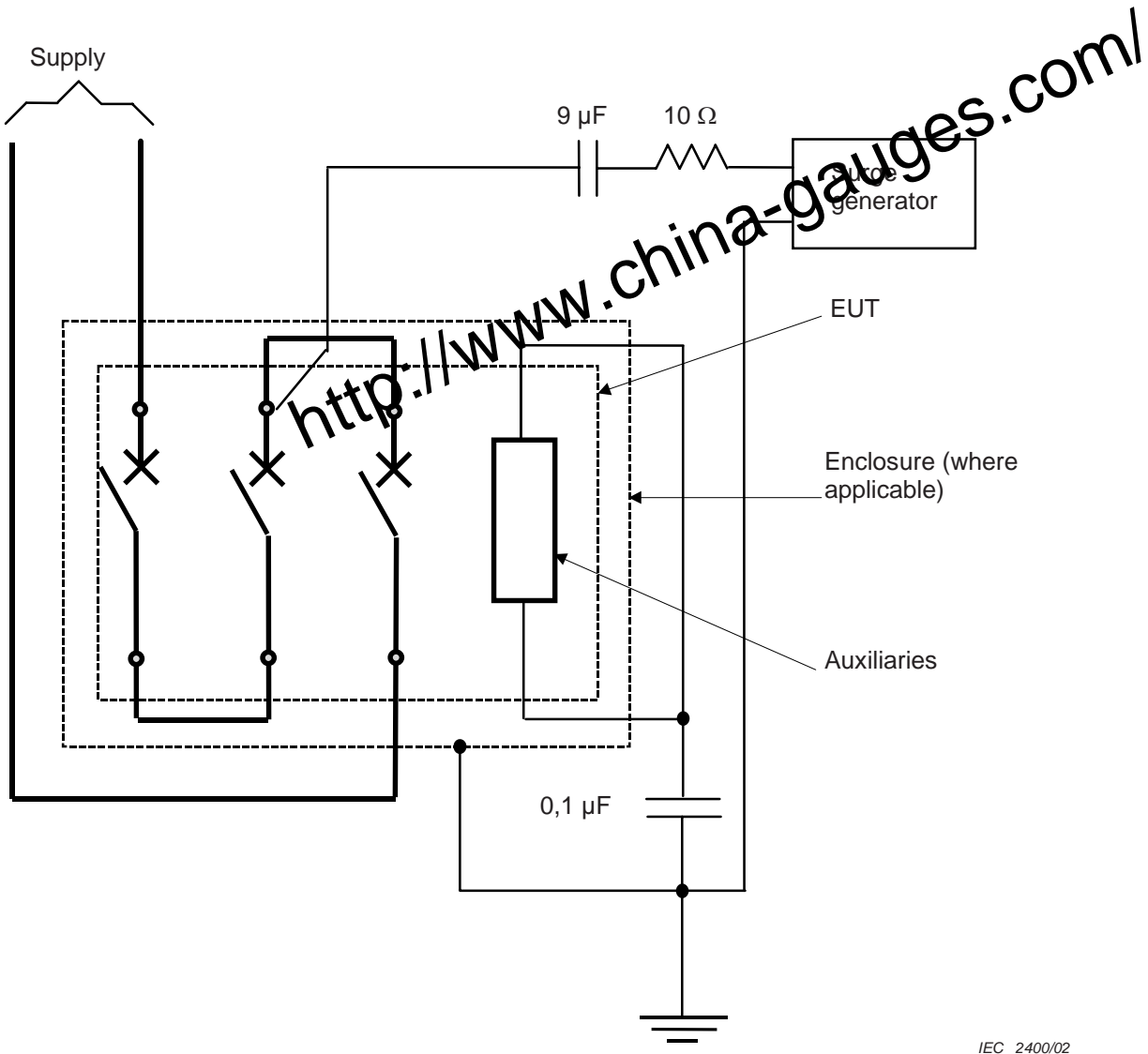
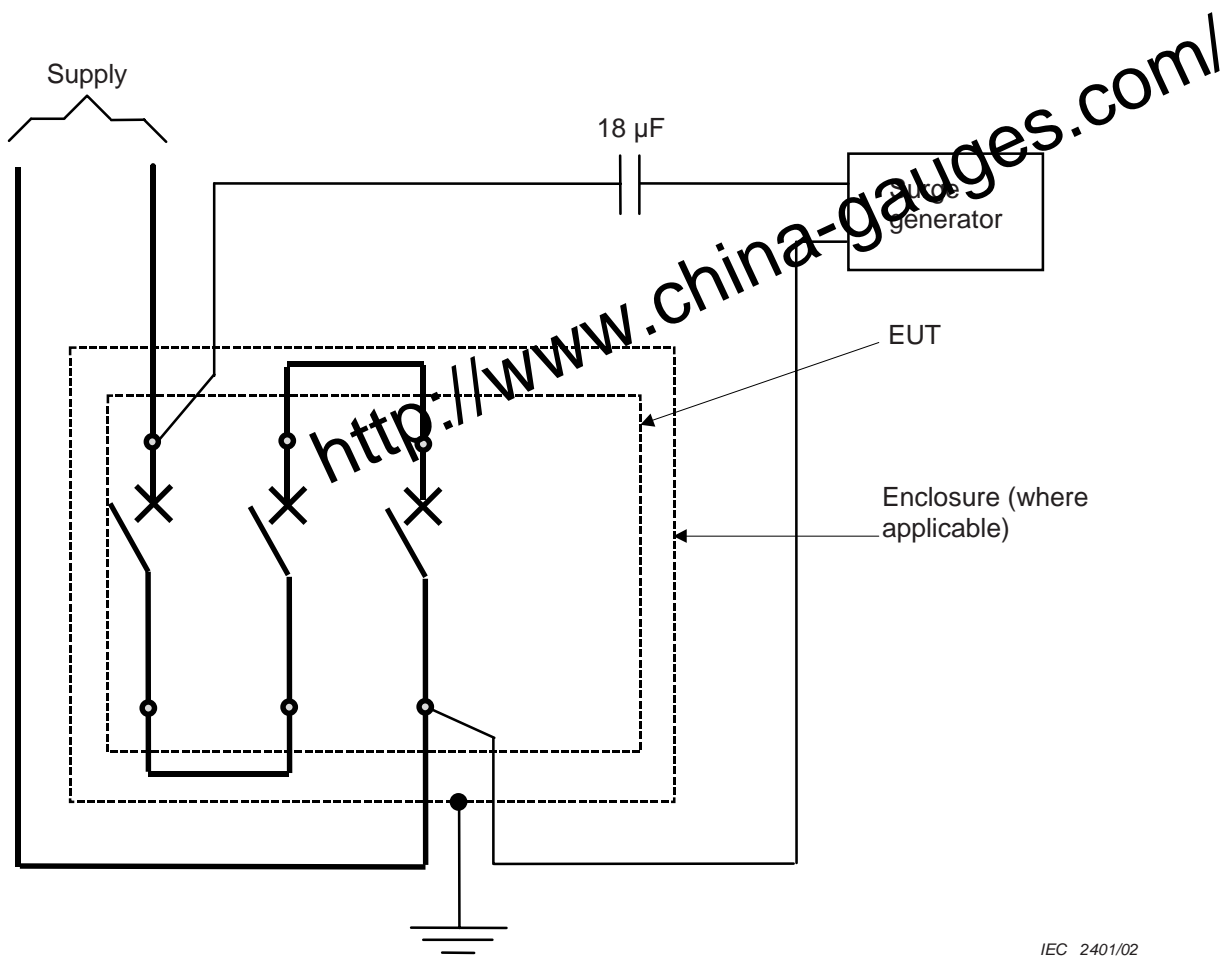

Figure 18 – Test circuit for the verification of the influence of current surges in the main circuit – Two-phase poles configuration



IEC 2400/02

**Figure 19 – Test circuit for the verification of the influence of surges in the main circuit (line-to-earth) – Three-phase poles in series configuration**



IEC 2401/02

Figure 20 – Test circuit for the verification of the influence of current surges in the main circuit – Three-phase poles in series configuration

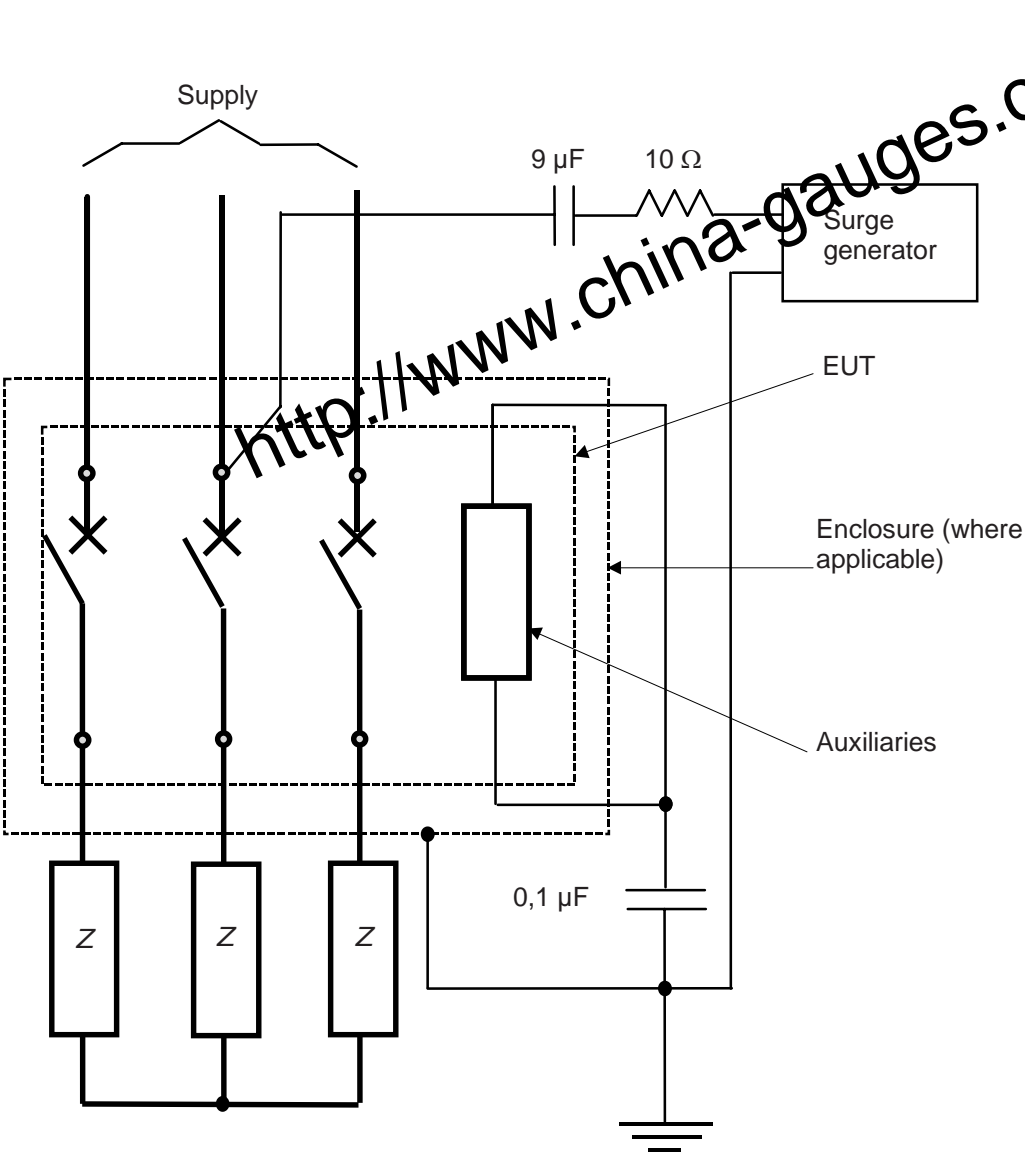

IEC 2402/02

**Key**

Z impedance for adjusting the current (where required)

**Figure 21 – Test circuit for the verification of the influence of surges in the main circuit (line to earth) – Three-phase configuration**

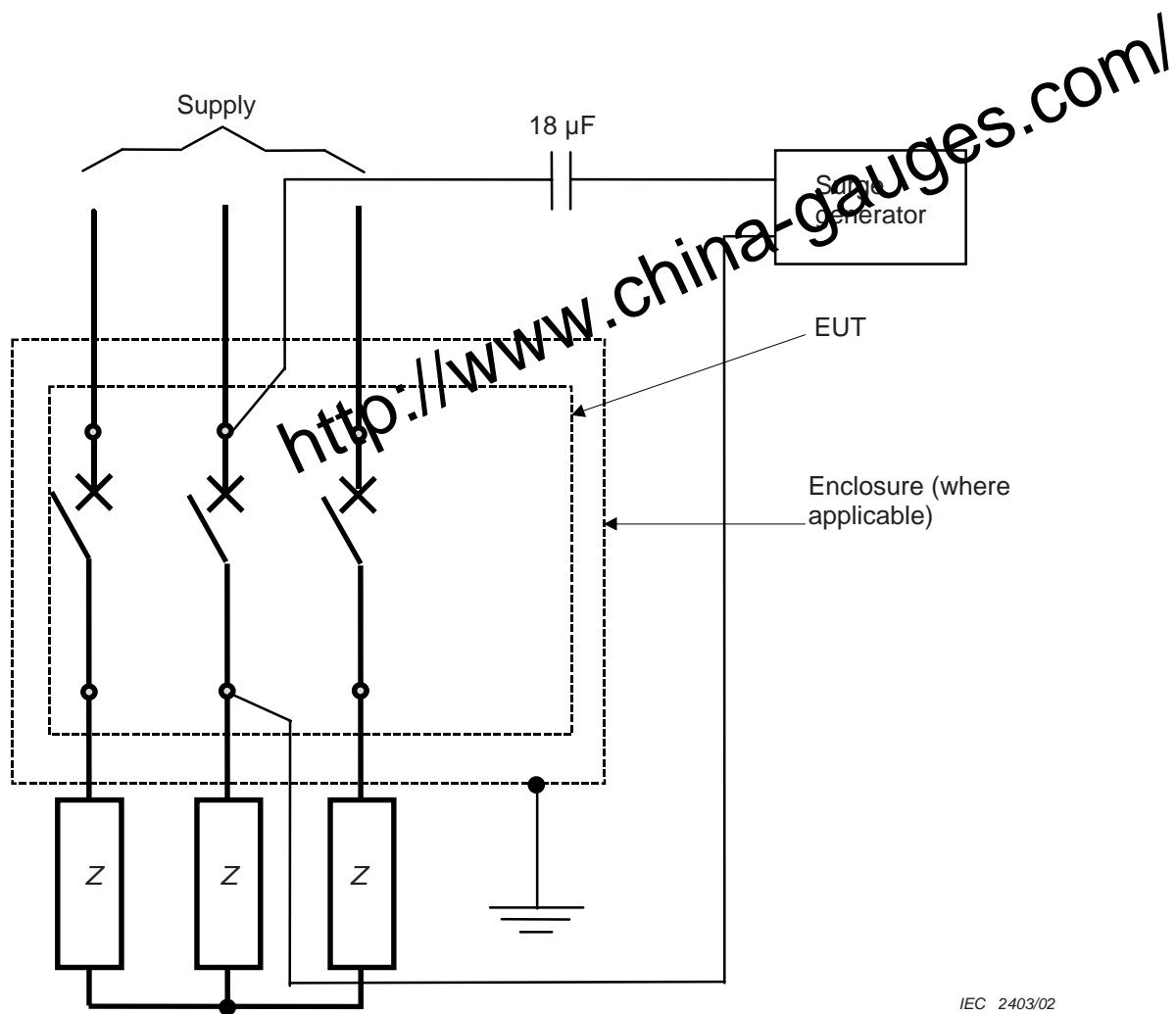

IEC 2403/02

**Key**

$Z$  impedance for adjusting the current (where required)

**Figure 22 – Test circuit for the verification of the influence of current surges in the main circuit – Three-phase configuration**

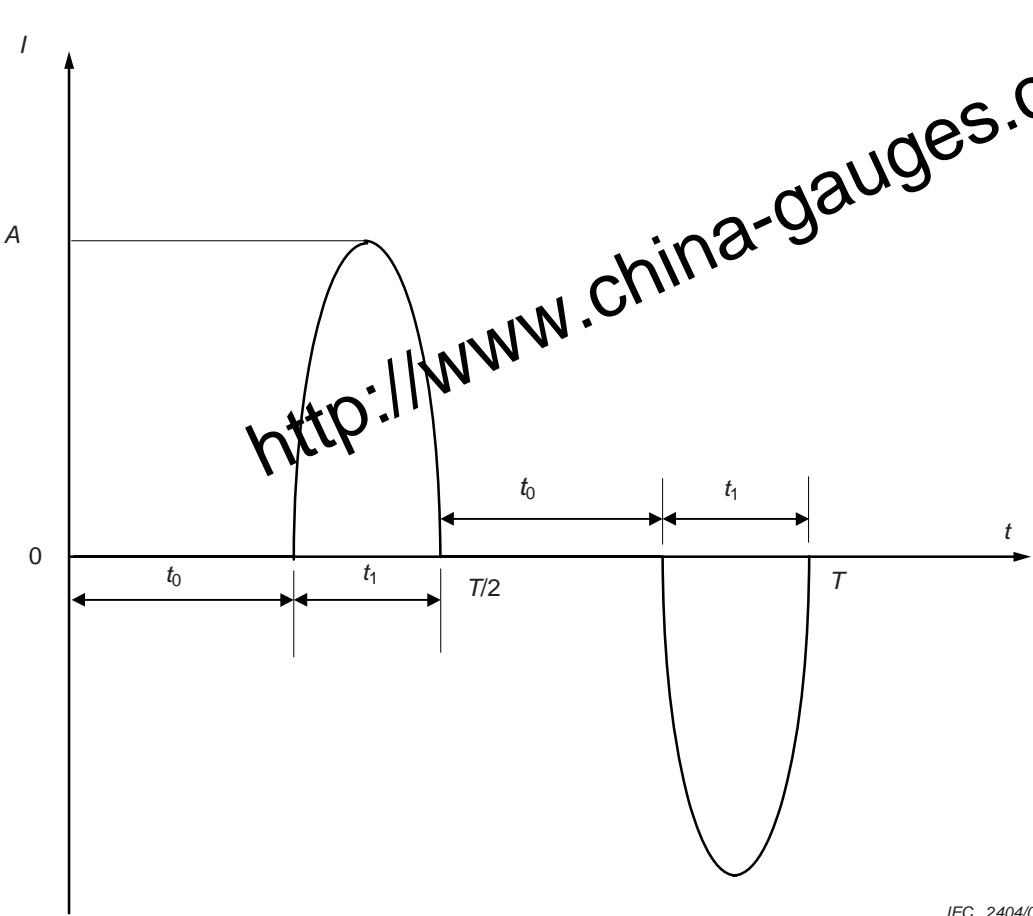

IEC 2404/02

**Key**

- $A$  peak current
- $T$  period
- $t_1$  conducting time during each half-cycle
- $t_0$  delay time

$$\text{Peak factor} = \frac{A}{\sqrt{\frac{2}{T} \int_0^{T/2} i^2(t) dt}}$$

**Figure 23 – Representation of test current produced by back-to-back thyristors**

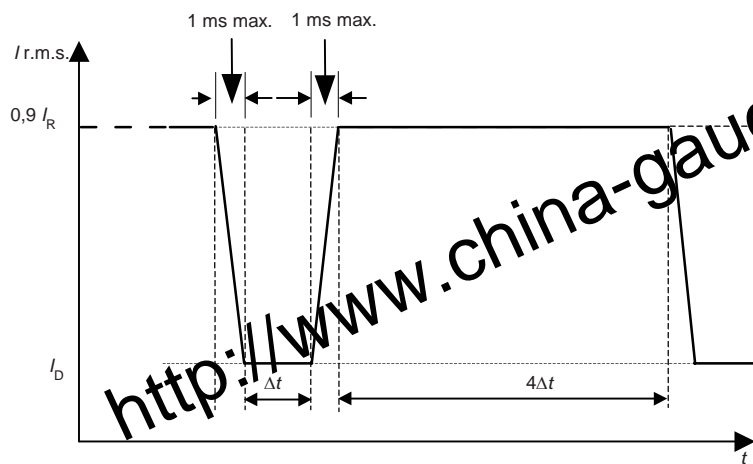

IEC 2405/02

**Key**

- $I_R$  setting current
- $I_D$  dip test current
- $\Delta t$  dip time
- $4\Delta t$  dwell time

**Figure 24 – Test current for the verification of the influence of the current dips and interruptions**

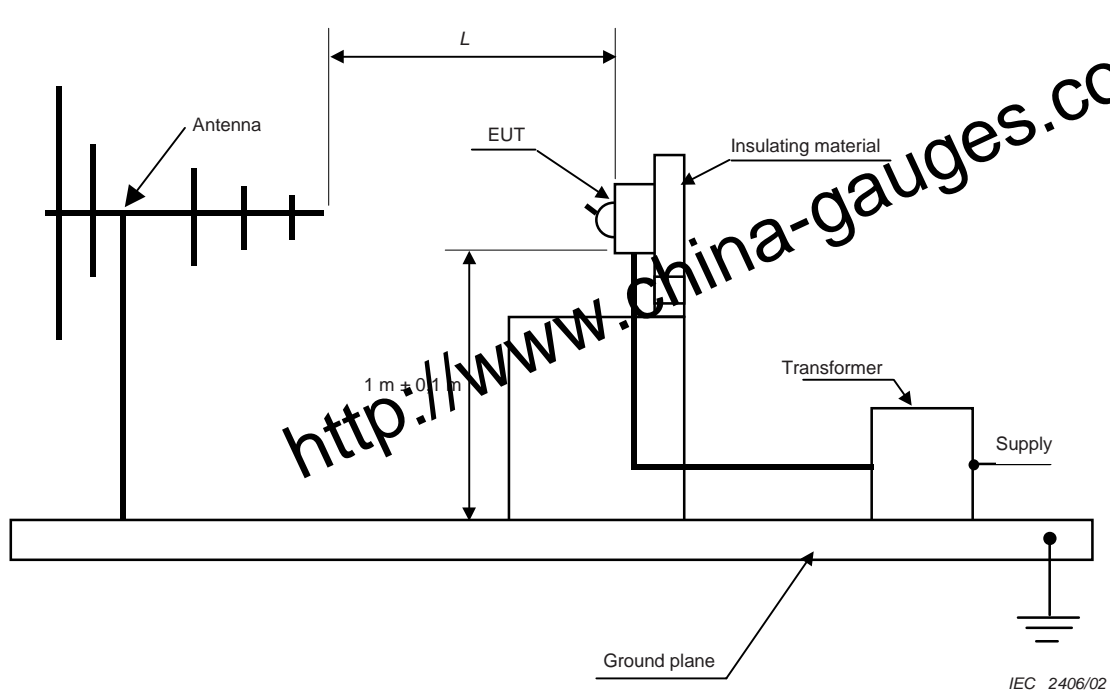

**Key**

*L* 10 m or 3 m according to reference standard

**Figure 25 – Radiated emission test set-up**

**A1**

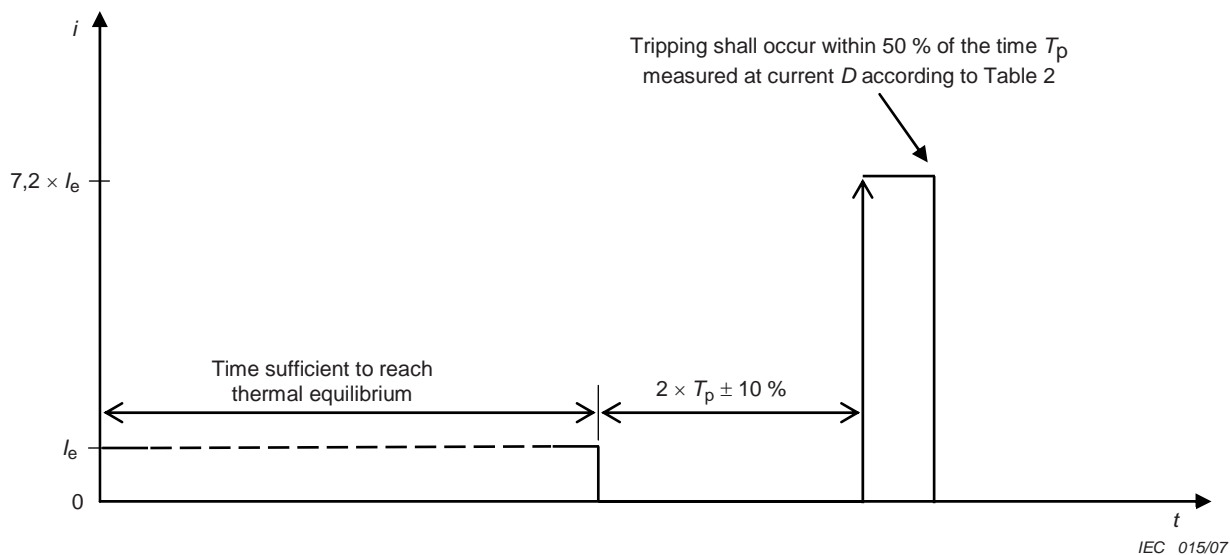

**Figure 26 – Thermal memory test **A1****



**Annex A**  
(normative)

**Special tests**

**A.1 General**

Special tests are made at the discretion of the manufacturer.

**A.2 Mechanical durability**

**A.2.1 General**

By convention, the mechanical durability of a design of a CPS is defined as the number of no-load operating cycles which would be attained or exceeded by 90 % of all the apparatus of this design before it becomes necessary to service or replace any mechanical parts; however, normal maintenance including replacement of contacts as specified in A.2.2.1 and A.2.2.3 is permitted.

The preferred numbers of no-load operating cycles, expressed in millions are:

0,001 – 0,003 – 0,01 – 0,03 – 0,1 – 0,3 – 1 – 3 and 10.

**A.2.2 Verification of mechanical durability**

**A.2.2.1 Condition of the CPS for tests**

The CPS shall be installed as for normal service; in particular, the conductors shall be connected in the same manner as for normal use.

During the test, there shall be no voltage or current in the main circuit.

**A.2.2.2 Operating conditions**

The control circuits shall be supplied at their rated voltage and, if applicable, at their rated frequency.

If a resistance or an impedance is provided in series with the coils, whether short-circuited or not during the operation, the tests shall be carried out with these elements connected as in normal operation.

**A.2.2.3 Test procedure**

- a) The tests are carried out at the frequency of operations corresponding to the class of intermittent duty. However, if the manufacturer considers that the CPS can satisfy the required conditions when using a higher frequency of operations, he may do so.
- b) For CPS's provided both with remote and manual control means, the operations shall be made through remote control means on one sample and through manual control means on another sample.

- c) In the case of electromagnetic CPS's, the duration of energization of the control coil shall be greater than the time operation of the CPS and the time for which the coil is not energized shall be of such a duration that the CPS can come to reset at both extreme positions.

The number of operating cycles to be carried out shall be not less than the number of no-load operating cycles stated by the manufacturer.

- d) For CPS fitted with releases shunt coils or under-voltage releases, at least 10 % of the total number of opening operations shall be performed by these releases.

#### A.2.2.4 Results to be obtained

Following the tests for mechanical durability, the CPS shall still be capable of complying with the operating conditions specified in 8.2.1.2 and 9.3.3.2 at room temperature.

Any timing relays or other devices for the automatic control shall still be operating.

#### A.2.2.5 Statistical analysis of test results for CPS

The mechanical durability of a CPS design is assigned by the manufacturer and verified by a statistical analysis of the results of this test.

For CPS's which are produced in small quantities, the tests described in A.2.2.6 and A.2.2.7 do not apply. However, for CPS which are produced in small quantities and which also differ from a basic design only by detailed variations (i.e. without any significant variation) without notable influence on characteristics, the manufacturer may assign mechanical durability on the basis of experience with similar designs, analysis, properties of materials, etc., and on the basis of the analysis of test results on large scale production of the same basic design.

After this assignment, a test shall be performed. The test is one or the other of the two described below, selected by the manufacturer as most suitable in each case, for example according to the quantities of planned production or according to the conventional thermal current.

NOTE This test is not intended to be a batch-by-batch or production acceptance test for application by the user.

#### A.2.2.6 Single 8 test

Eight CPS's shall be tested to the assigned mechanical durability.

If the number of failures does not exceed two, the test is considered passed.

#### A.2.2.7 Double 3 test

Three CPS's shall be tested for the assigned mechanical durability.

The test is considered passed if there is no failure, and failed if there is more than one failure. Should there be one failure, three additional CPS are tested up to assigned mechanical durability and providing there is no additional failure, the test is considered passed. The test is failed if at any time there is a total of two or more failures.

#### EXPLANATORY NOTE

The single 8 test and the double 3 test are both given in IEC 60410 (see table X-D-2 and X-C-2).

These two tests were chosen with the objectives of basing them on testing a limited number of CPS's and on essentially the same statistical characteristics (acceptance quality level: 10 %).

### A.3 Electrical durability

#### A.3.1 General

With respect to its resistance to electrical wear, a CPS is by convention characterized by the number of on-load operating cycles, corresponding to the several utilization categories given in table 12 which can be made without repair or replacement.

The manufacturer may give values of electrical durability obtained

- under normal load and overload conditions
- after short-circuit (after operation cycles O-t-CO-t-rCO at  $I_{CS}$ )

For categories AC-43 and AC-44, the test circuit shall comprise inductors and resistors so arranged as to give the appropriate values of current, voltage, power-factor given in table 12 and, moreover for AC-44, the test circuit for testing the making and breaking capacity shall be used, see 9.3.3.5.

The operating cycle (ON time and OFF time) shall be chosen by the manufacturer.

The test shall be taken as valid if the values recorded in the test report are not less than 95 % of the values specified for current and voltage.

Tests shall be carried out with the CPS under the appropriate conditions of A.2.2.1 and A.2.2.2 using the test procedure, where applicable, of A.2.2.3, except that replacement of contacts is not permitted.

After the test, the CPS shall fulfill the operating conditions specified in 9.3.3.2 and withstand a dielectric test voltage given in 8.3.3.4.1, item 4) b), of IEC 60947-1, and applied as in 8.3.3.4.1, item 4), of IEC 60947-1; the test voltage being applied only

- between all poles connected together and the frame of the CPS, and
- between each pole and all the other poles connected to the frame of the CPS.

Annex B

Vacant

Annex C  
(normative)  
Marking and identification of CPS terminals

C.1 General

The purpose of identifying terminals of a CPS is to provide information regarding the function of each terminal or its location with respect to other terminals or for other use.

C.2 Marking and identification of terminals of CPS's

C.2.1 Marking and identification of terminals of cells

In the case of identification by alphanumeric markings, both terminals of a coil for an electromagnetic contactor shall be marked A.1 and A.2.

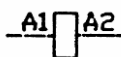

For a coil with tapplings, the terminals of the tapplings shall be marked in sequential order A.3, A.4, etc.

Examples:

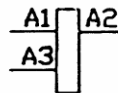
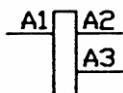

NOTE As a consequence of this, both incoming and outgoing terminals may have even or odd numbers.

For a coil having two windings, the terminals of the first winding shall be marked A.1, A.2 and of the second winding B.1, B.2.

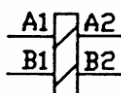

### C.2.2 Marking and identification of terminals of main circuits

The terminals of the main circuits shall be marked by single figure numbers and an alphanumeric system.

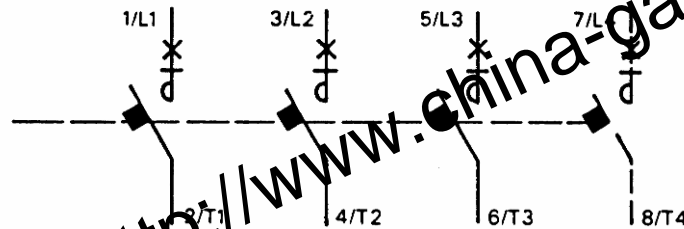

NOTE The present two alternative methods of marking, i.e. 1-2 and L1-T1 respectively will be progressively superseded by the new method above.

Alternatively, terminals may be identified on the wiring diagram supplied with the device.

### C.2.3 Marking and identification of terminals of auxiliary circuits

The terminals of auxiliary circuits shall be marked or identified on the diagrams by two figure numbers:

- the unit number is a function number;
- the figure of the tens is a sequence number.

The following examples illustrate such a marking system:

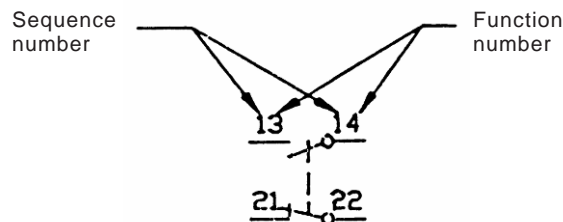

#### C.2.3.1 Function number

Function numbers 1, 2 are allocated to circuits with break contacts and function numbers 3, 4 to circuits with make contacts.

NOTE The definitions for break contacts and make contacts are given in 2.3.12 and 2.3.13 of Part 1.

Examples:

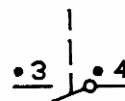
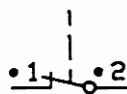

NOTE The dots on the above example take the place of the sequence numbers which should be added appropriate to the application.

The terminals of circuits with change-over contact elements shall be marked by the function numbers 1, 2 and 4.

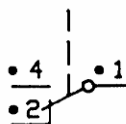

Function numbers 5 and 6 (for break contacts) and 7 and 8 (for make contacts) are allocated to terminals of auxiliary circuits containing auxiliary contacts with special functions.

Examples:

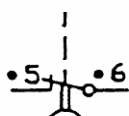

Break contact  
delayed on closing

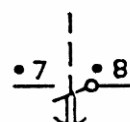

Make contact  
delayed on closing

The terminals of circuits with change-over contact elements with special functions shall be marked by the function numbers 5, 6 and 8.

Example:

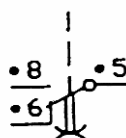

Change-over contact  
delayed in both directions

### C.2.3.2 Sequence number

Terminals belonging to the same contact element shall be marked by the same sequence number.

All contact elements having the same function shall have different sequence numbers.

Examples:

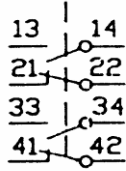

Four contact elements

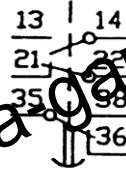

Three contact elements

For terminals of the auxiliary circuits of over-current protective devices the sequence numbers 9 and 0 are preferred and, in every case, auxiliary terminals shall be identified on the wiring diagram supplied with the CPS.

**Annex D**  
(informative)

**Items subject to agreement between manufacturer and user**

NOTE For the purpose of this annex:

- *agreement* is used in a very wide sense;
- *user* includes testing stations.

Annex J of Part 1 applies, as far as covered by clauses and subclauses of this standard, with the following additions:

Clause or subclause number of this standard	Item
5.3.4 Note	Overload protection for intermittent duty.
5.4.1	Types of utilization other than the utilization categories defined in table 1.
5.7.1 4)	Use of relays or releases other than those listed in 5.7.1.3.
8.2.2.6.3	Ratings of specially rated windings (to be stated by the manufacturer).
Table 9	Verification of the make conditions for AC-43 and AC-44 when made during the make break test (manufacturer's agreement).
9.1.5	Special tests.
9.3.3.3.4	Testing method for temperature rise-tests of four-pole CPS having a conventional thermal current higher than 63 A.



**Annex E**  
(informative)

**Examples of control circuit configurations**

**E.1 External control device (ECD)**

**E.1.1 Definition of an ECD**

Any external element which serves to effect the control of the CPS.

**E.1.2 Diagrammatic representation of an ECD**

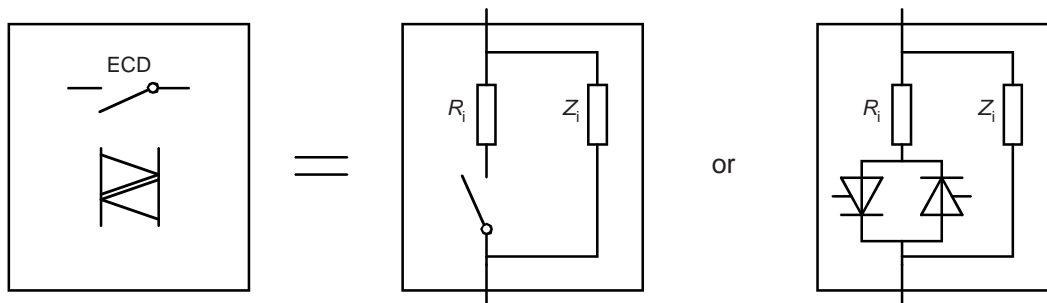

IEC 1215/99

**E.1.3 Parameters of an ECD**

- $R_i$ : internal resistance;
- $Z_i$ : internal leakage impedance.

NOTE In the case where ECD is a mechanical push-button,  $R_i$  is often neglected and  $Z_i$  is often taken as infinity ( $\infty$ ).

**E.2 Control circuit configurations**

**E.2.1 CPS with external control supply**

**E.2.1.1 Single supply and control input**

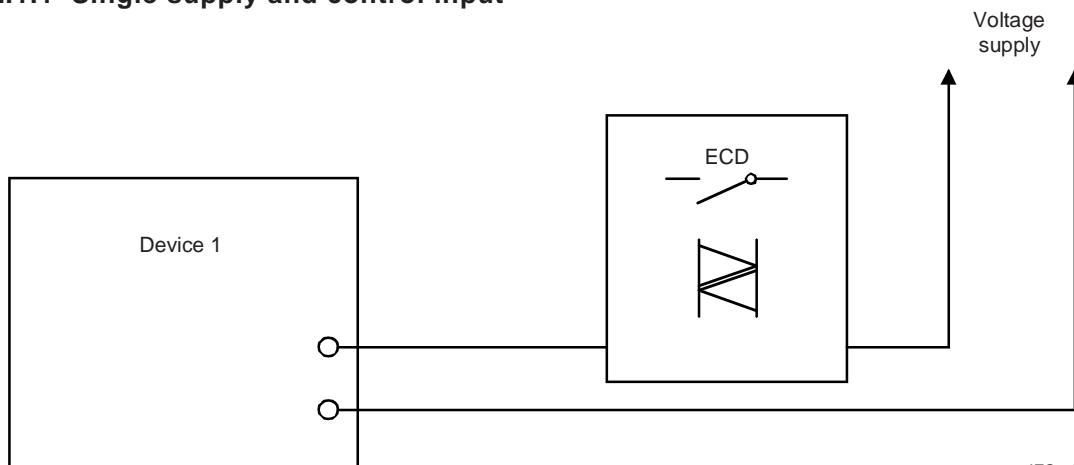

IEC 1216/99

**A1) E.2.1.2 Separate supply and control inputs**

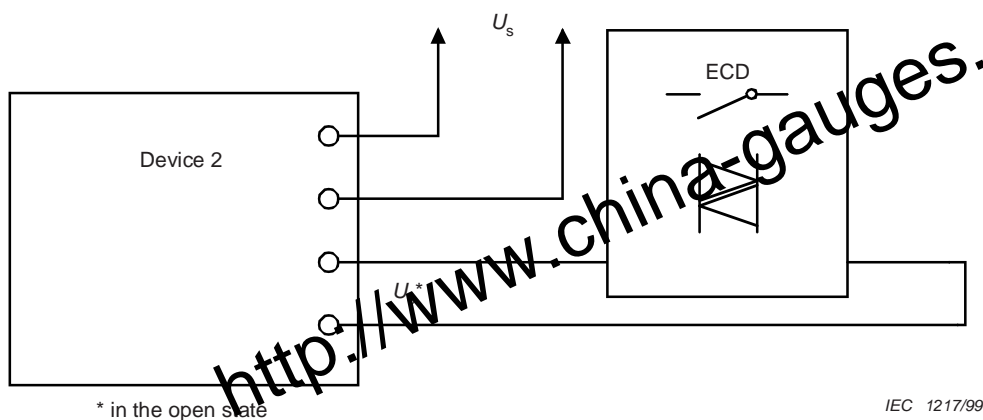

IEC 1217/99

**E.2.2 CPS with an internal control supply and control input only**

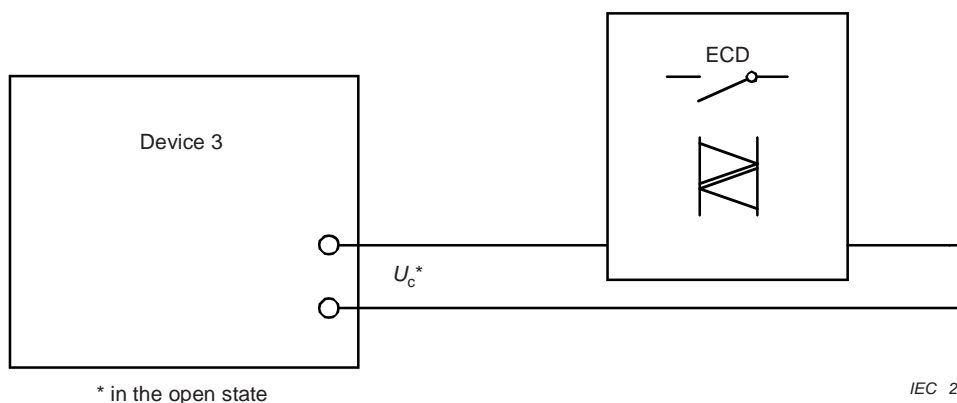

IEC 2133/02

**E.2.3 CPS with several external control supplies**

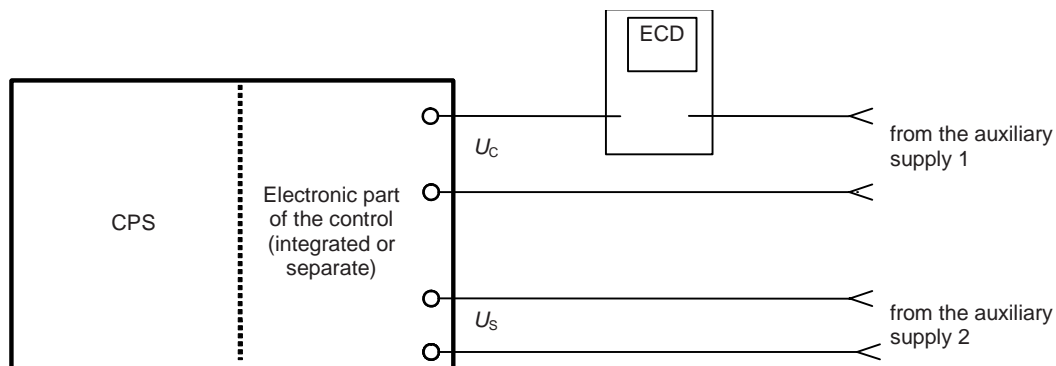

IEC 016/07

**A1** E.2.4 CPS with bus interface (may be combined with other circuit configurations)

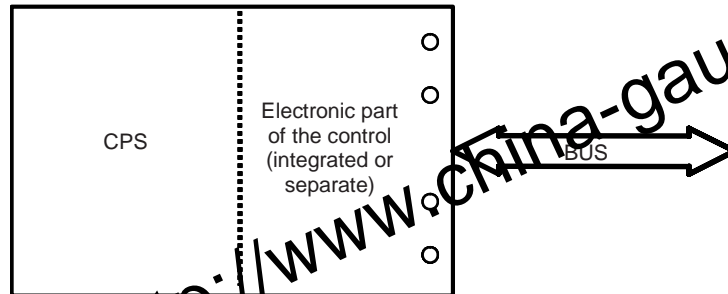

**Annex F**  
(normative)

**Coordination under short-circuit conditions between a CPS and another short-circuit protective device associated in the same circuit**

**F.1 Introduction**

To ensure coordination under short-circuit conditions between a CPS ( $C_1$ ) and another short-circuit protective device (SCPD) associated with it in the same circuit, it is necessary to consider the characteristics of each of the two devices as well as their behaviour as an association.

NOTE 1 An SCPD may incorporate additional protective means, for example, overload releases.

The SCPD may consist of a fuse (or a set of fuses) – see Figure F.1 – or of another CPS or of a circuit-breaker ( $C_2$ ) (see Figures F.2 to F.5).

NOTE 2 Unless otherwise specified, cases where the associated SCPD is another CPS or a circuit-breaker will be considered as one case as the behaviour is the same in both cases; this will be referred as CPS/circuit-breaker.

The comparison of the individual operating characteristics of each of the two associated devices may not be sufficient, when reference has to be made to the behaviour of these two devices operating in series, since the impedance of the devices is not always negligible. This should be taken into account. For short-circuit currents it is recommended that reference be made to  $I^2t$  instead of time.

$C_1$  is frequently connected in series with another SCPD for reasons such as the method of power distribution adopted for the installation or because the short-circuit breaking capacity of  $C_1$  alone may be insufficient for the proposed application. In such instances the SCPD may be mounted in locations remote from  $C_1$ . The SCPD may be protecting a main feeder supplying a number of CPSs  $C_1$  or just an individual CPS. **A1**

**A1)** For such applications the user or specifying authority may have to decide, on the basis of a desk study alone, how the optimum level of coordination may best be achieved. This annex is intended to give guidance for this decision, and also on the type of information which the CPS manufacturer should make available to the prospective user.

Guidance is also given on test requirements, where such tests are deemed necessary for the proposed application.

The term "coordination" includes consideration of discrimination (see 2.5.23 of IEC 60947-1 and also 2.17.2 and 2.17.3 of IEC 60947-2) as well as consideration of back-up protection (see 2.5.24 of IEC 60947-1).

Consideration of discrimination can in general be carried out by desk study (see Clause F.5), whereas the verification of back-up protection normally requires the use of tests (see Clause F.6).

When considering short-circuit breaking capacity, reference may be made to the rated ultimate short-circuit breaking capacity ( $I_{cu}$ ), or to the rated service short-circuit breaking capacity ( $I_{cs}$ ), according to the desired criterion.

## F.2 Scope and object

This annex gives guidance on and requirements for the coordination of CPSs with other SCPDs associated in the same circuit, as regards discrimination as well as back-up protection.

The object of this annex is to state

- the general requirements for the coordination of a CPS with another SCPD;
- the methods and the tests (if deemed necessary) intended to verify that the conditions for coordination have been met.

## F.3 General requirements for the coordination of a CPS with another SCPD

### F.3.1 General considerations

Ideally, the coordination should be such that a CPS ( $C_1$ ) alone will operate at all values of over-current up to the limit of its rated service short-circuit breaking capacity  $I_{cs}$ .

NOTE 1 If the value of the prospective fault current at the point of installation is less than the rated service short-circuit breaking capacity of  $C_1$ , it may be assumed that the SCPD is only in the circuit for considerations other than those of back-up protection.

In practice, the following considerations apply:

- a) if the value of the selectivity limit current  $I_s$  (see 2.17.4 of IEC 60947-2) is too low, there is a risk of unnecessary loss of discrimination;
- b) if the value of the prospective fault current at the point of installation exceeds the rated service short-circuit breaking capacity of  $C_1$ , the SCPD shall be so selected that the behaviour of  $C_1$  is in accordance with F.3.3 and the take-over current  $I_B$  (see 2.17.6 of IEC 60947-2), if any, complies with the requirements of F.3.2.

Whenever possible, the SCPD shall be located on the supply side of  $C_1$ . If the SCPD is located on the load side, it is essential that the connection between  $C_1$  and the SCPD be so arranged as to minimize any risk of short circuit.

NOTE 2 In the case of interchangeable releases, these considerations should apply to each relevant release. **A1)**

### **A1) F.3.2 Take-over current**

For the purpose of back-up protection, the take-over current  $I_B$  shall not exceed the rated service short-circuit breaking capacity  $I_{CS}$  of  $C_1$  alone (see Figure F.4).

### **F.3.3 Behaviour of $C_1$ in association with another SCPD**

For all values of over-current up to and including the short-circuit breaking capacity of the association,  $C_1$  shall comply with the requirements of 7.2.5 of IEC 60947-1, and the association shall comply with the requirements of 8.6.1.5.2.

Where tests on combinations of short-circuit protective devices for over-current co-ordination are not performed (see 2.5.22 of IEC 60947-1), the manufacturer shall provide information (usually curves) showing

- maximum cut-off (let-through) peak current (see 2.5.19 of IEC 60947-1) as a function of prospective current (r.m.s. symmetrical);
- $I^2t$  characteristics (see 3.11).

Conformity with this information may be checked during the relevant type tests in test sequences III and IV (see Table 16).

### **F.4 Type and characteristics of the associated SCPD**

On request, the manufacturer of the CPS shall provide information on the type and the characteristics of the SCPD to be used with  $C_1$ , and on the maximum prospective short-circuit current for which the association is suitable at the stated operational voltage.

Details of the SCPD used for any tests made in accordance with this annex, i.e. manufacturer's name, type designation, rated voltage, rated current and short-circuit breaking capacity, shall be given in the test report.

The maximum conditional short-circuit current (see 2.5.29 of IEC 60947-1) shall not exceed the rated ultimate short-circuit breaking capacity of the SCPD or the rated service short-circuit breaking capacity of the SCPD in case of no rated ultimate short-circuit breaking capacity.

If the associated SCPD is a CPS, it shall meet the requirements of this standard, or any other relevant standard.

If the associated SCPD is a fuse, it shall be in accordance with the appropriate fuse standard.

### **F.5 Verification of discrimination**

Discrimination can normally be considered by desk study alone, i.e. by a comparison of the operating characteristics of  $C_1$  and the associated SCPD, for example, when the associated SCPD is a CPS/circuit-breaker ( $C_2$ ) provided with an intentional time-delay.

The manufacturers of both the  $C_1$  and the SCPD shall provide adequate data concerning the relevant operating characteristics so as to permit  $I_S$  to be determined for each individual association.

In certain cases, tests at  $I_S$  are necessary on the association, for example

- when  $C_1$  is of the current-limiting type and  $C_2$  is not provided with an intentional time-delay;
- when the opening time of the SCPD is less than that corresponding to one half-cycle. **A1**

**A1**) To obtain the desired discrimination when the associated SCPD is a CPS/circuit-breaker, an intentional short-time delay may be necessary for  $C_2$ .

Discrimination may be partial (see Figure F.4) or total up to the rated short-circuit breaking capacity  $I_{cu}$  (or  $I_{cs}$ ) of  $C_1$ . For total discrimination, the non-tripping characteristic of  $C_2$  or the pre-arcing characteristic of the fuse shall lie above the tripping (break time) characteristic of  $C_1$ .

Two illustrations of total discrimination are given in Figures F.2 and F.3.

## F.6 Verification of back-up protection

### F.6.1 Determination of the take-over current

Compliance with the requirements of F.3.2 can be checked by comparing the operating characteristics of  $C_1$  and the associated SCPD for all settings of  $C_1$  and, if applicable, for all settings of  $C_2$ .

### F.6.2 Verification of back-up protection

#### a) Verification by tests

Compliance with the requirements of F.3.3 is normally verified by tests in accordance with F.6.3. In this case, all the conditions for the tests shall be as specified in 9.3.4.1 with the adjustable resistors and inductors for the short-circuit tests on the supply side of the upstream device under test.

#### b) Verification by comparison of characteristics

In some practical cases and where the SCPD is a CPS/circuit-breaker (see Figures F.4 and F.5), it may be possible to compare the operating characteristics of  $C_1$  and of the associated SCPD, special attention being paid to the following:

- the Joule integral value of  $C_1$  at its  $I_{cs}$  and that of the SCPD at the prospective current of association;
- the effects on  $C_1$  (e.g. by arc energy, by maximum peak current, cut-off current) at the peak operating current of the SCPD.

The suitability of the association may be evaluated by considering the maximum total operating  $I^2t$  characteristic of the SCPD, over the range from the rated short-circuit breaking capacity  $I_{cu}$  (or  $I_{cs}$ ) of  $C_1$  up to the prospective short-circuit current of the application, but not exceeding the maximum let-through  $I^2t$  of  $C_1$  at its rated short-circuit breaking capacity or other lower limiting value stated by the manufacturer.

NOTE Where the associated SCPD is a fuse, the validity of the desk study is limited up to  $I_{cu}$  (or  $I_{cs}$ ) of  $C_1$ .

### F.6.3 Tests for verification of back-up protection

If  $C_1$  is fitted with adjustable over-current opening releases, the operating characteristics shall be those corresponding to the minimum time and current settings.

If  $C_1$  can be fitted with instantaneous over-current opening releases, the operating characteristics to be used shall be those corresponding to  $C_1$  fitted with such releases.

If the associated SCPD is a CPS/circuit-breaker ( $C_2$ ) fitted with adjustable over-current opening releases, the operating characteristics to be used shall be those corresponding to the maximum time and current settings. **A1**

**A1)** If the associated SCPD consists of a set of fuses, each test shall be made using a new set of fuses, even if some of the fuses used during a previous test have not blown.

Where applicable, the connecting cables shall be included as specified in 9.3.4.1.6 except that, if the associated SCPD is a CPS/circuit-breaker ( $C_2$ ), the full length of cable (0,75 m) associated with this SCPD may be on the supply side (see Figure F.4).

Each test shall consist of a O–t–CO sequence of operations made in accordance with 9.3.4.1.6 and with 8.3.5 of IEC 60947-2, whether at  $I_{cu}$  or  $I_{cs}$ , the CO operation being made on  $C_1$ .

A test is made with the maximum prospective current for the proposed application. This shall not exceed the rated conditional short-circuit (see 4.3.6.4 of IEC 60947-1).

A further test shall be made at a value of prospective current equal to the rated short-circuit breaking capacity  $I_{cs}$  of  $C_1$ , for which test a new sample  $C_1$  may be used, and also, if the associated SCPD is a circuit-breaker, a new sample  $C_2$ .

During each operation

a) if the associated SCPD is a CPS/circuit-breaker ( $C_2$ ):

- either both  $C_1$  and  $C_2$  shall trip at both test currents, no further tests then being required.

This is the general case and provides back-up protection only.

- or  $C_1$  shall trip and  $C_2$  shall be in the closed position at the end of each operation, at both test currents, no further tests then being required.

The contacts of  $C_2$  are allowed to separate momentarily during each operation. In this case restoration of the supply is provided, in addition to back-up protection (see note 1 to Figure F.4). The duration of contact separation of  $C_2$ , if any, shall be recorded during these tests.

- or  $C_1$  shall trip at the lower test current, and both  $C_1$  and  $C_2$  shall trip at the higher test current.

The contacts of  $C_2$  are allowed to separate momentarily at the lower test current. Additional tests shall be made at intermediate currents to determine the lowest current at which both  $C_1$  and  $C_2$  trip, up to which current restoration of supply is provided. The duration of contact separation of  $C_2$ , if any, shall be recorded during these tests.

b) if the associated SCPD is a fuse (or a set of fuses):

- in the case of a single-phase circuit at least one fuse shall blow;
- in the case of a multi-phase circuit either two or more fuses shall blow, or one fuse shall blow and  $C_1$  shall trip.

#### F.6.4 Results to be obtained

Subclause 8.3.4.1.7 of IEC 60947-1 applies.

Following the tests,  $C_1$  shall comply with 9.4.4.4 and 9.4.4.6.

In addition, if the associated SCPD is a CPS/circuit-breaker ( $C_2$ ), it shall be verified, by manual operation or other appropriate means, that the contacts of  $C_2$  have not welded. **A1)**

A1

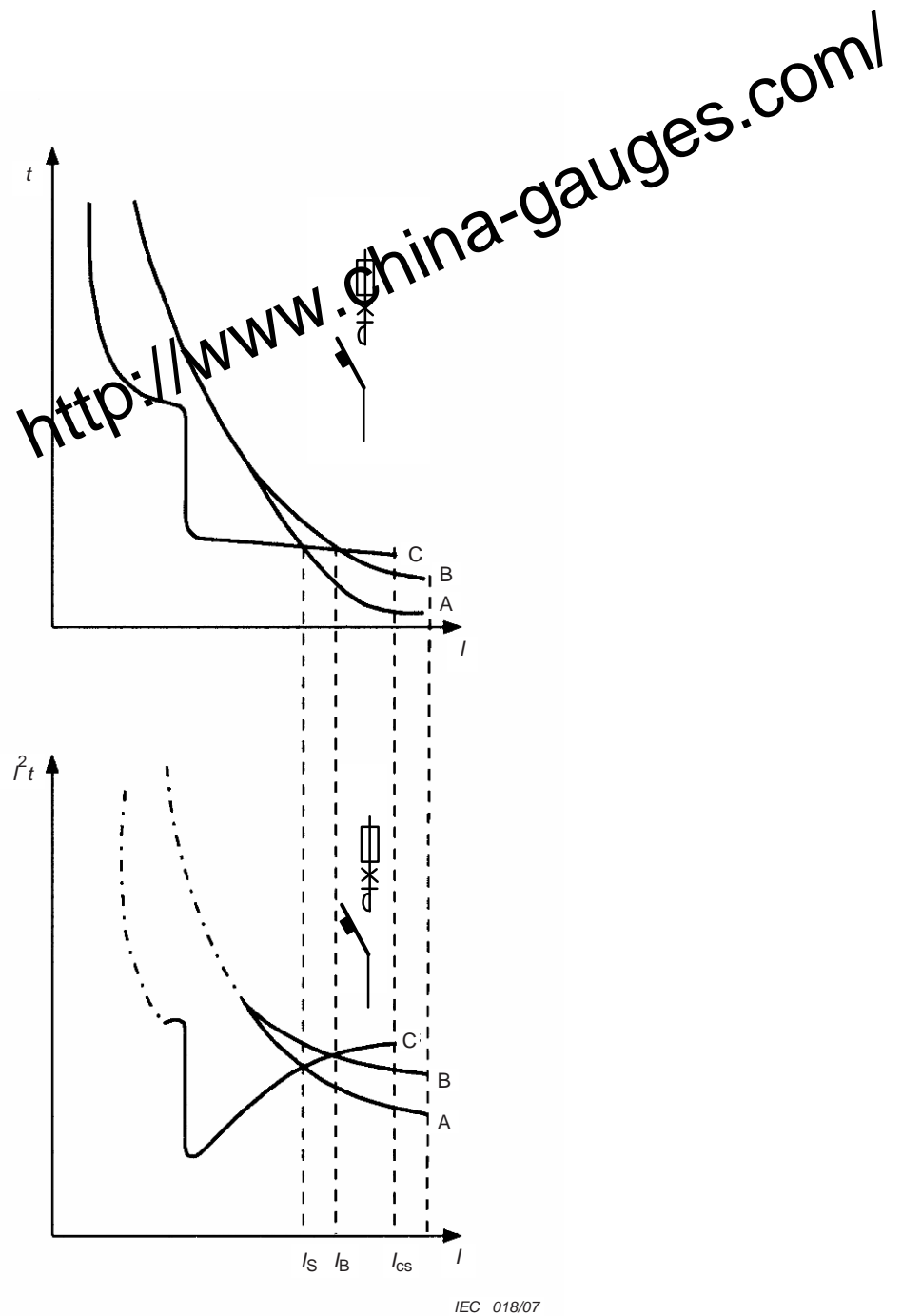

- $I$  prospective short-circuit current
- $I_{CS}$  rated service short-circuit breaking capacity (5.3.6.1)
- $I_S$  selectivity limit current (2.17.4 of IEC 60947-2)
- $I_B$  take-over current (2.17.6 of IEC 60947-2)
- A pre-arcing characteristic of the fuse
- B operating characteristic of the fuse
- C operating characteristic of the CPS (break-time/current and  $I^2t$ /current)

NOTE 1 A is deemed to be the lower limit; B and C are deemed to be the upper limits.

NOTE 2 Non-adiabatic zone for  $I^2t$  shown chain-dotted.

**Figure F.1 – Over-current coordination between a CPS and a fuse or back-up protection by a fuse: operating characteristics** A1



A1

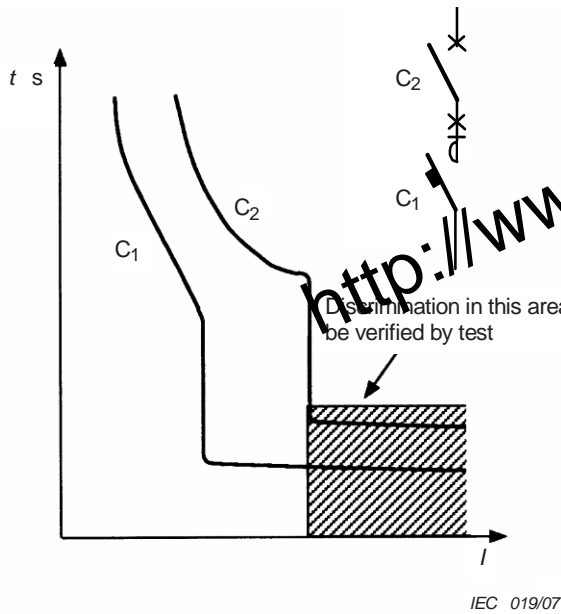

C<sub>1</sub> current-limiting CPS  
(break-time characteristic)  
C<sub>2</sub> non-current-limiting circuit-breaker  
(tripping characteristic)  
Values of  $I_{cu}$  (or  $I_{cs}$ ) are not shown.

**Figure F.2 – Total discrimination  
between CPSs and circuit-breakers –  
Case 1**

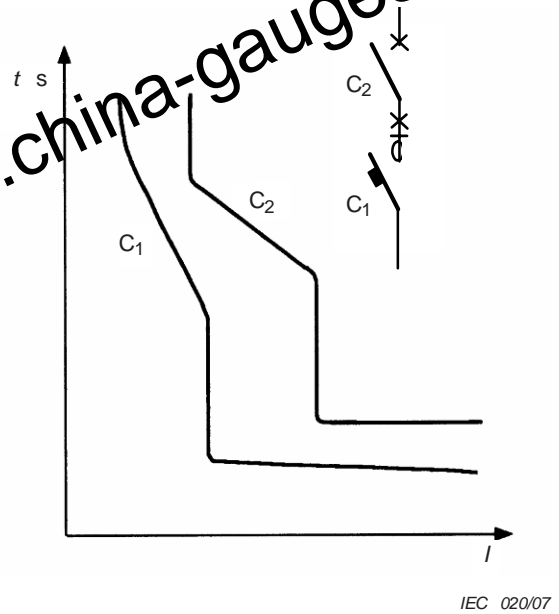

C<sub>1</sub> non-current-limiting CPS  
(break-time characteristic)  
C<sub>2</sub> circuit-breaker with intentional short-time  
delay (tripping characteristic)  
Values of  $I_{cu}$  (or  $I_{cs}$ ) are not shown.

**Figure F.3 – Total discrimination  
between CPSs and circuit-breakers –  
Case 2** A1

A1

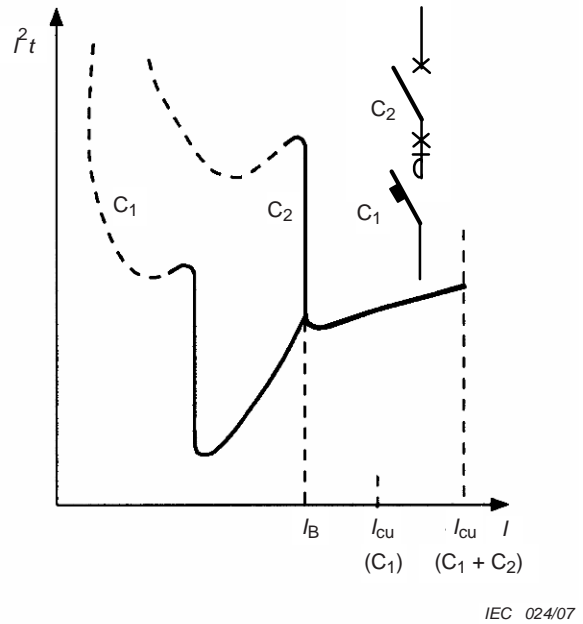
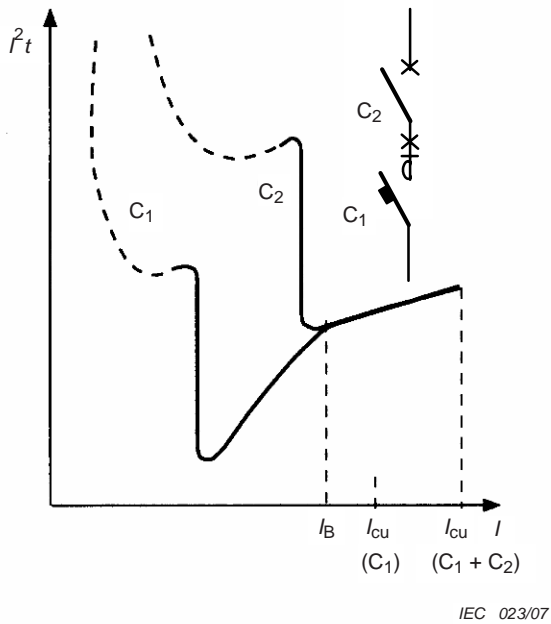
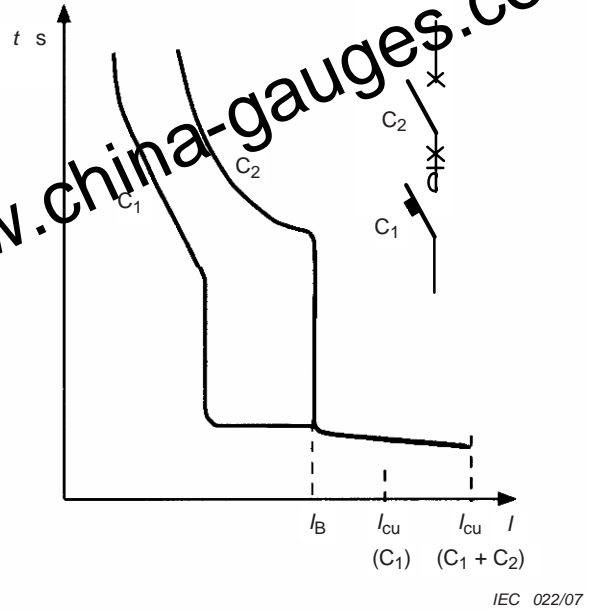
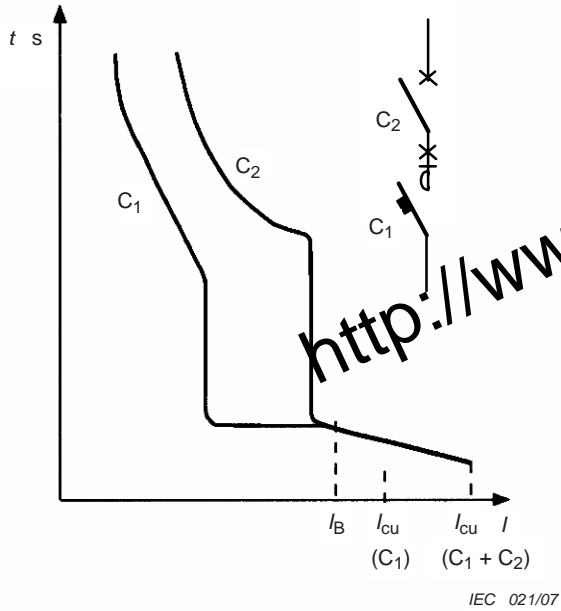

C<sub>1</sub> non current-limiting CPS/circuit-breaker  
 C<sub>2</sub> current-limiting CPS/circuit-breaker  
 I<sub>B</sub> take-over current

C<sub>1</sub>, C<sub>2</sub> non current-limiting CPS/circuit-breaker  
 I<sub>B</sub> take-over current

NOTE 1 Where applicable, restoration of supply by C<sub>2</sub> occurs.

NOTE 2  $I_{cu} (C_1 + C_2) \leq I_{cu} (C_2)$ .

NOTE 3 For values of  $I > I_B$ , the curve is that of the association (shown in bold) for which data shall be obtained by tests.

**Figure F.4 – Back-up protection by a CPS/circuit-breaker – Operating characteristics – Case 1**

**Figure F.5 – Back-up protection by a CPS/circuit-breaker – Operating characteristics – Case 2** A1

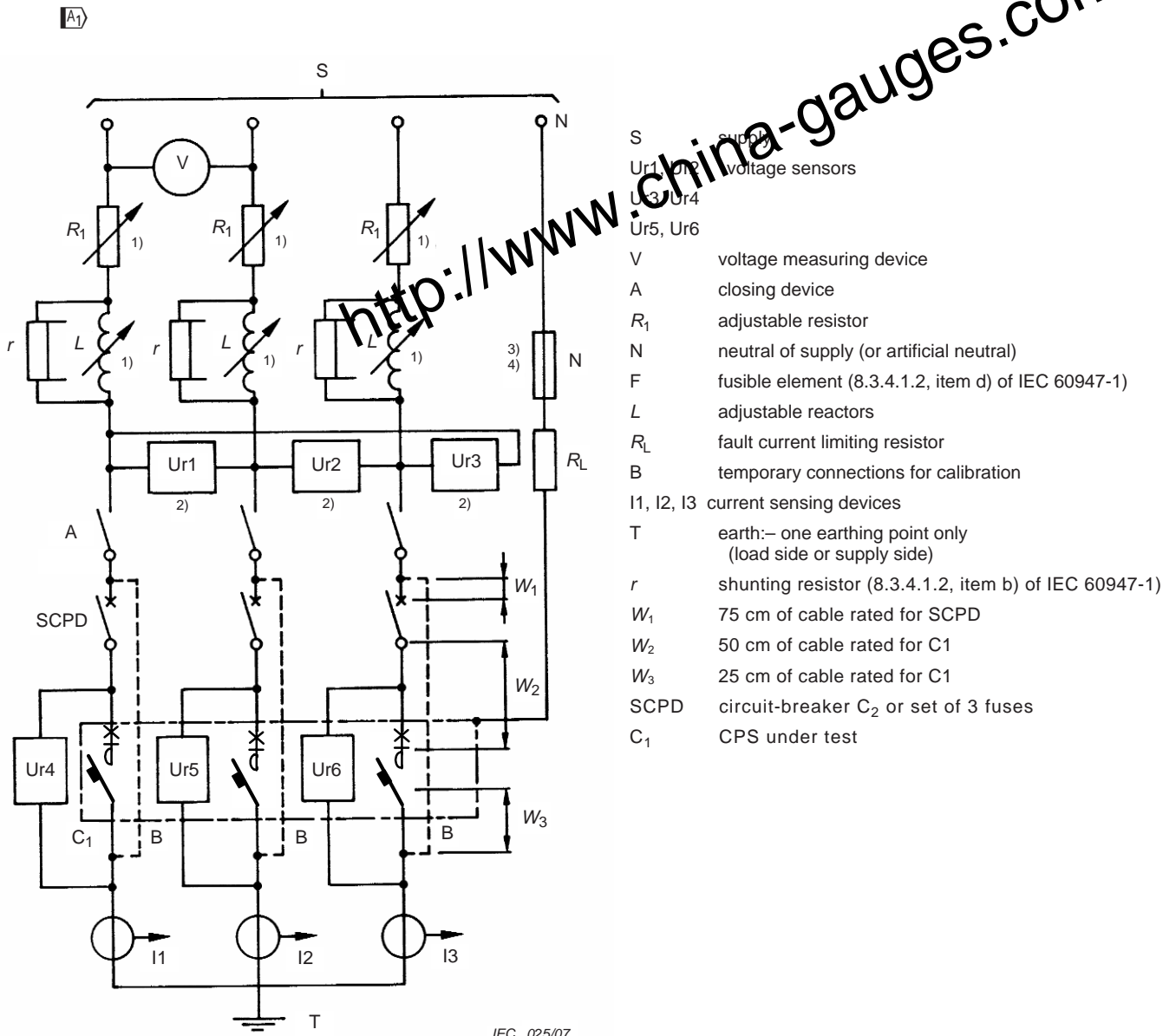

NOTE 1 Adjustable loads  $L$  and  $R_1$  may be located either on the high-voltage side or on the low-voltage side of the supply circuit, the closing device  $A$  being located on the low-voltage side.

NOTE 2  $Ur_1, Ur_2, Ur_3$  may, alternatively, be connected between phase and neutral.

NOTE 3 In the case of devices intended for use in a phase-earthed network,  $F$  is connected to one phase of the supply.

NOTE 4 In the USA and Canada (see note to 4.3.1.1 of IEC 60947-2)  $F$  is connected

- to one phase of the supply for equipment marked with a single value of  $U_e$ ;
- to the neutral for equipment marked with a twin voltage of  $U_e$ .

**Figure F.6 – Example of test circuit for conditional short-circuit breaking capacity tests showing cable connections for a 3-pole CPS ( $C_1$ )** A1

**A1** Annex G  
 (normative)

**Test sequence for CPSs for IT systems**

NOTE This test sequence is intended to cover the case of a second fault to earth in presence of a first fault on the opposite side of a CPS when installed in IT systems (see 4.3.1.1 of IEC 60947-2).

**G.1 General**

This test sequence applies to multipole CPSs for application on IT systems, in accordance with 4.3.1.1 of IEC 60947-2; it comprises the following tests:

Test	Clause
Individual pole short-circuit ( $I_{IT}$ )	G.2
Verification of dielectric withstand	G.3
Verification of overload releases	G.4

**G.2 Individual pole short circuit**

A short-circuit test is made on the individual poles of a multipole CPS under the general conditions of 9.3.4.1, at a value of current  $I_{IT}$  equal to

- 1,2 times the maximum setting of the short-time delay release tripping current or, in the absence of such a release, 1,2 times the maximum setting of the tripping current of the instantaneous release,

or, where relevant,

- 1,2 times the maximum setting of the definite time delay release tripping current,

but not exceeding 50 kA.

NOTE 1 The prospective current of the test circuit may have to be increased to ensure that the test current exceeds the actual short-time or instantaneous pick-up current, allowing for the impedance of the CPS and its connections

NOTE 2 Values higher than  $I_{IT}$  may be required, tested instead and declared by the manufacturer.

The applied voltage shall be the phase-to-phase voltage corresponding to the maximum rated operational voltage of the CPS at which it is suitable for application on IT systems. The number of samples to be tested and the setting of adjustable releases shall be in accordance with Table G.1. The power factor shall be according to Table 16 of IEC 60947-1, appropriate to the test current. When  $I_{IT} = 50$  kA, the short-time or instantaneous pick-up setting shall be adjusted to the nearest setting lower than (50/1,2) kA.

**Table G.1 – Individual pole**

Number of marked $U_e$ ratings			Number of samples	Current setting	Test voltage
1	2	Mul.			
X	X	X	1	Max.	$U_e$ max

**A1)** For 4-pole CPSs with a protected neutral pole, the test voltage for that pole shall be phase-to-phase voltage divided by  $\sqrt{3}$ . This test is applicable only where the construction of the protected neutral pole differs from that of the phase poles.

The test circuit shall be in accordance with 8.3.4.1.2 and Figure 9 of IEC 60947-1, the supply S being derived from two phases of a three-phase supply, the fusible element F being connected to the remaining phase. The remaining phase poles shall also be connected to this phase via the fusible element F.

The sequence of operations shall be as follows:

$t - t - CO$  (see 9.3.4.1.6)

and shall be made on each pole separately, in turn.

### **G.3 Verification of dielectric withstand**

Following the test according to Clause G.2, the dielectric withstand shall be verified according to 9.4.4.4.

### **G.4 Verification of overload releases**

Following the test according to Clause G.3, the operation of the overload releases shall be verified according to 9.4.4.6.

### **G.5 Marking**

CPSs for which all values of rated voltage have been tested according to this annex or are covered by such testing require no additional marking.

CPSs for which all values of rated voltage have not been tested according to this annex or are not covered by such testing shall be identified in accordance with Clause H.5 of IEC 60947-2. **A1)**

**Annex H**  
(normative)

**Extended functions within electronic overload relays or releases**

NOTE For the purposes of this annex, the term "relays" covers both relays and releases.

**H.1 Scope**

**H.1.1 General**

This annex is intended to cover extended functions included in electronic overload relays not directly related to the overload protection.

All functions included in these overload relays not covered by this standard should comply with the requirements of relevant standards specifically covering these functions (e.g. IEC 60255, IEC 60947-5 series).

This annex applies only to electronic relays intended for use in a.c. circuits.

**H.1.2 Residual current function**

Devices reacting to residual differential currents are used as protective systems. Such devices are frequently used in conjunction with or as an integral part of electronic overload relays to detect residual current in the installation or the motor in order to provide additional protection against fire and other hazards which may develop as a result of an earth fault of a lasting nature which cannot be detected by the over-current protective function. The behaviour due to the presence of a d.c. component is not considered.

**H.2 Definitions**

For the purposes of this annex, the following definitions apply.

**H.2.1**

**electronic overload relay with residual current (earth fault) function**

multipole electronic relay which operates when the vectorial sum of the currents flowing in the main circuit has increased above a predetermined value in accordance with specified requirements

**H.2.2**

**electronic overload relay with current or voltage asymmetry function**

electronic overload relay which operates in the case of current or voltage magnitude unbalance in accordance with specified requirements

**H.2.3**

**electronic overload relay with phase reversal function**

multipole electronic overload relay which operates in the case of improper phase sequence at the line side of the CPS in accordance with specified requirements  $\square_{A1}$

**A1** H.2.4

**over-voltage sensitive electronic overload relay**

electronic overload relay which operates in the case of overload and when the voltage has increased above a predetermined value in accordance with specified requirements

**H.2.5**

**inhibit current**

$I_{ic}$

fault current above which a switching device is not initiated to open

**H.3 Classification of electronic overload relays**

- a) Current and voltage asymmetrical relay.
- b) Over-voltage relay.
- c) Residual current (earth fault) sensing relay.
- d) Phase reversal relay.

**H.4 Type of relays**

Type A: a Type A electronic overload relay is one that will initiate opening of the switching device at all levels of fault current.

Type B: a Type B electronic overload relay is one that will not initiate opening of the switching device above a set current level  $I_{ic}$  (inhibit current).

**H.5 Performance requirements**

**H.5.1 Limits of operation of residual current electronic overload relays**

A residual current overload relay, when controlling the CPS, shall operate to open the CPS according to the requirements given in Table H.1. For relays with a residual current setting range, the limit of operation of the relay shall be verified at the lowest and highest settings.

**Table H.1 – Operating time of residual current electronic overload relays**

Multiples of residual current setting	Tripping time $T_p$ ms
$\leq 0,9$	No trip
1,1	$10 < T_p \leq 1\ 000$

**H.5.2 Limits of operation of residual current sensing electronic relays Type B**

Subclause H.5.1 applies with the following addition.

A residual current sensing electronic relay Type B shall not initiate operation of the switching device, in the presence of a residual fault current, when the fault current in any phase reaches or exceeds 95 % of the set current level  $I_{ic}$  (see H.4) and shall operate to open the equipment when the fault current in any phase is 75 % or less of  $I_{ic}$ . **A1**

### **A1) H.5.3 Limits of operation of voltage asymmetry relays**

A voltage asymmetry relay, when controlling the CPS, shall operate to open the CPS within 120 % of the time setting and shall operate to prevent the closing of the CPS when the voltage asymmetry is above 1,2 times the voltage asymmetry setting.

### **H.5.4 Limits of operation of phase reversal relays**

A phase reversal relay, when controlling the CPS, shall permit the closing of the CPS when the voltage sequence of phases on the line side of the CPS is the same as the voltage sequence setting. After interchanging two phases, the phase reversal relay shall prevent the closing of the CPS.

### **H.5.5 Limits of operation of current asymmetry relays**

A current asymmetry relay, when controlling the CPS, shall operate to open the CPS within 120 % of the time setting when the current asymmetry is above 1,2 times the current asymmetry setting.

### **H.5.6 Limits of operation of over-voltage relays**

#### **a) Operating voltage**

An over-voltage relay, when controlling the CPS, shall operate to open the CPS and shall operate to prevent the closing of the CPS when the supply voltage is above the set value, if any, or above 110 % of the rated voltage of the relay for a defined duration.

#### **b) Operating time**

For a time-delay over-voltage relay, the time-lag shall be measured from the instant when the voltage reaches the operating value until the instant when the relay actuates the tripping device of the equipment.

## **H.6 Tests**

### **H.6.1 Limits of operation of residual current sensing electronic relays Type A**

The limits of operation shall be in accordance with H.5.1 and verified as follows.

For overload relays with an adjustable residual current setting, the test shall be made at the minimum and at the maximum current settings.

The test circuit shall be in accordance with Figure H.1. The test shall be made at a power factor  $\geq 0,8$ , at any convenient voltage and any convenient current.

The test circuit being calibrated at each of the values of the residual operating current specified in the Table H.1, as applicable, and the switch S1 being in the closed position, the residual current is suddenly established by closing switch S2.

### **H.6.2 Limits of operation of residual current sensing electronic relays Type B**

Subclause H.6.1 applies with the following addition.

The limits of operation under over-current condition shall be in accordance with H.5.2 and verified as follows. **A1)**



**A1)** The test shall be made with a three-phase load, the connections being made according to Figure H.1. The test shall be made at a power factor  $\geq 0,8$ , at any convenient voltage and any convenient current in the main poles.

For overload relays with an adjustable residual current setting, the test shall be made at the lowest setting.

For overload relays with an adjustable inhibit current setting  $I_{ic}$ , the test shall be made at the minimum and at the maximum  $I_{ic}$  settings.

The impedance Z1 is adjusted so as to let a current flow in the circuit equal to

a) 95 % of the inhibit current  $I_{ic}$

The switch S1 being in the closed position, the residual current is established by closing switch S2.

The overload relay shall not trip.

b) 75 % of the inhibit current  $I_{ic}$

The switch S1 being in the closed position, the residual current is established by closing switch S2.

The overload relay shall trip.

### **H.6.3 Current asymmetry relays**

The limits of operation shall be verified in accordance with H.5.5.

### **H.6.4 Voltage asymmetry relays**

The limits of operation shall be verified in accordance with H.5.3.

### **H.6.5 Phase reversal relays**

The limits of operation shall be verified in accordance with H.5.4.

### **H.6.6 Over-voltage relays**

The limits of operation shall be verified in accordance with H.5.6.

## **H.7 Routine and sampling tests**

Electronic overload relays with extended functions shall be, in addition to tests of 9.3.6, submitted to additional tests to verify the proper operation of their relevant additional functions, according to H.5. **A1)**

A1

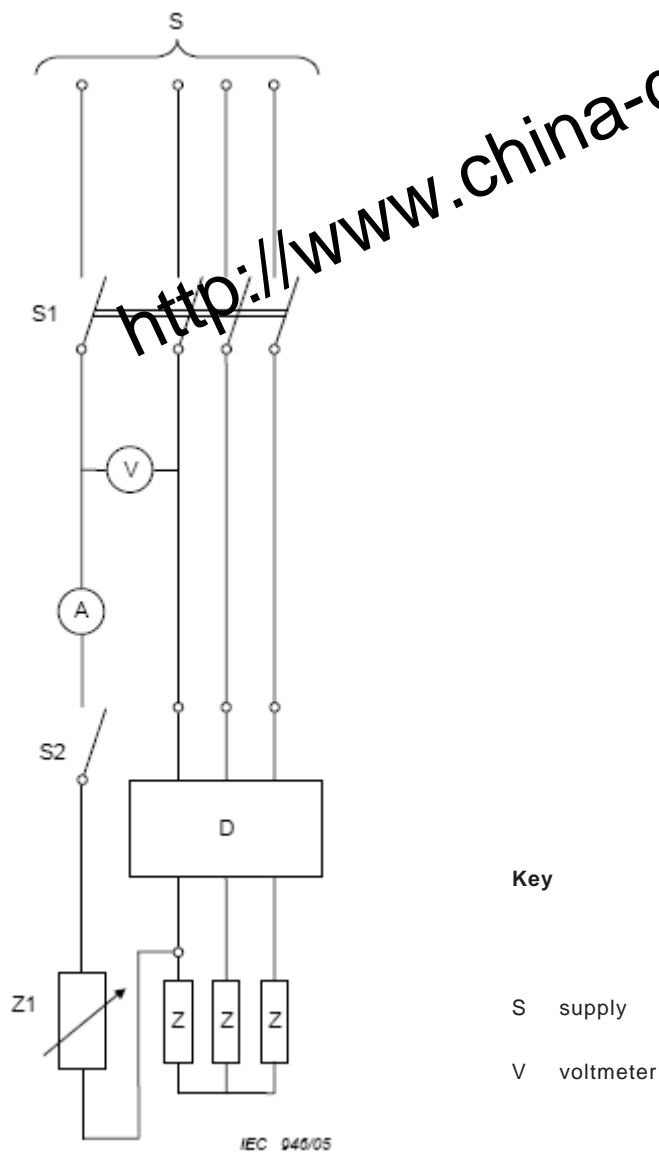

NOTE For the purpose of clarification, only the residual current electronic overload relay part of the CPS is shown.

**Figure H.1 – Test circuit for the verification of the operating characteristic of a residual current electronic overload relay A1**

**Annex ZA**  
(normative)

**Normative references to international publications  
with their corresponding European publications**

The following referenced documents are indispensable to the application of this document. For dated references, only the edition cited applies. For undated references, the latest edition of the referenced document (including any amendments) applies.

NOTE When an international publication has been modified by common modifications, indicated by (mod), the relevant EN/HD applies.

<u>Publication</u>	<u>Year</u>	<u>Title</u>	<u>EN/HD</u>	<u>Year</u>
IEC 60034-1	2004	Rotating electrical machines - Part 1: Rating and performance	EN 60034-1	2004
IEC 60085	2004	Electrical insulation - Thermal classification	EN 60085	2004
IEC 60410	1973	Sampling plans and procedures for inspection by attributes	-	-
IEC 60695-2-10	2000	Fire hazard testing - Part 2-10: Glowing/hot-wire based test methods - Glow-wire apparatus and common test procedure	EN 60695-2-10	2001
IEC 60695-2-11	2000	Fire hazard testing - Part 2-11: Glowing/hot-wire based test methods - Glow-wire flammability test method for end-products	EN 60695-2-11	2001
IEC 60695-2-12	2000	Fire hazard testing - Part 2-12: Glowing/hot-wire based test methods - Glow-wire flammability test method for materials	EN 60695-2-12	2001
IEC 60695-2-13	2000	Fire hazard testing - Part 2-13: Glowing/hot-wire based test methods - Glow-wire ignitability test method for materials	EN 60695-2-13	2001
IEC 60695-11-10 A1	1999 2003	Fire hazard testing - Part 11-10: Test flames - 50 W horizontal and vertical flame test methods	EN 60695-11-10 A1	1999 2003

<u>Publication</u>	<u>Year</u>	<u>Title</u>	<u>EN/HD</u>	<u>Year</u>
IEC 60947-1	2004	Low-voltage switchgear and controlgear - Part 1: General rules	EN 60947-1 + corr. November 2004	2004
IEC 60947-2	2006	Low-voltage switchgear and controlgear - Part 2: Circuit-breakers	EN 60947-2	2006
IEC 60947-6-1	1989	Low-voltage switchgear and controlgear - Part 6-1: Multiple function equipment - Automatic transfer switching equipment	EN 60947-6-1 <sup>1)</sup>	1991
A1	1994		A1	1994
A2	1997		A2	1997
IEC 61000-4-2	1995	Electromagnetic compatibility (EMC) - Part 4-2: Testing and measurement techniques - Electrostatic discharge immunity test	EN 61000-4-2	1995
A1	1998		A1	1998
A2	2000		A2	2001
IEC 61000-4-3	2006	Electromagnetic compatibility (EMC) - Part 4-3: Testing and measurement techniques - Radiated, radio-frequency, electromagnetic field immunity test	EN 61000-4-3	2006
IEC 61000-4-4	2004	Electromagnetic compatibility (EMC) - Part 4-4: Testing and measurement techniques - Electrical fast transient/burst immunity test	EN 61000-4-4	2004
IEC 61000-4-5	1995	Electromagnetic compatibility (EMC) - Part 4-5: Testing and measurement techniques - Surge immunity test	EN 61000-4-5 <sup>2)</sup>	1995
A1	2000		A1	2001
IEC 61000-4-6 + A1 + A2	2003 2004 2006	Electromagnetic compatibility (EMC) - Part 4-6: Testing and measurement techniques - Immunity to conducted disturbances, induced by radio-frequency fields	EN 61000-4-6	- 200X <sup>3)</sup>
IEC 61131-2	2003	Programmable controllers - Part 2: Equipment requirements and tests	EN 61131-2 + corr. August	2003 2003

<sup>1)</sup> EN 60947-6-1 is superseded by EN 60947-6-1:2005, which is based on IEC 60947-6-1:2005.

<sup>2)</sup> EN 61000-4-5 is superseded by EN 61000-4-5:2006, which is based on IEC 61000-4-5:2005.

<sup>3)</sup> To be ratified.

<u>Publication</u>	<u>Year</u>	<u>Title</u>	<u>EN/HD</u>	<u>Year</u>
CISPR 11 (mod)	2003	Industrial scientific and medical (ISM) radio-		
+ A1	2004	frequency equipment - Electromagnetic	EN 55011	2007
A2	2006	disturbance characteristics - Limits and	A2	2007
		methods of measurement		

<http://www.china-gauges.com/>

---

---

## BSI — British Standards Institution

BSI is the independent national body responsible for preparing British Standards. It presents the UK view on standards in Europe and at the international level. It is incorporated by Royal Charter.

### Revisions

British Standards are updated by amendment or revision. Users of British Standards should make sure that they possess the latest amendments or editions.

It is the constant aim of BSI to improve the quality of our products and services. We would be grateful if anyone finding an inaccuracy or ambiguity while using this British Standard would inform the Secretary of the technical committee responsible, the identity of which can be found on the inside front cover.  
Tel: +44 (0)20 8996 9000. Fax: +44 (0)20 8996 7400.

BSI offers members an individual updating service called PLUS which ensures that subscribers automatically receive the latest editions of standards.

### Buying standards

Orders for all BSI, international and foreign standards publications should be addressed to Customer Services. Tel: +44 (0)20 8996 9001.  
Fax: +44 (0)20 8996 7001. Email: [orders@bsi-global.com](mailto:orders@bsi-global.com). Standards are also available from the BSI website at <http://www.bsi-global.com>.

In response to orders for international standards, it is BSI policy to supply the BSI implementation of those that have been published as British Standards, unless otherwise requested.

### Information on standards

BSI provides a wide range of information on national, European and international standards through its Library and its Technical Help to Exporters Service. Various BSI electronic information services are also available which give details on all its products and services. Contact the Information Centre.  
Tel: +44 (0)20 8996 7111. Fax: +44 (0)20 8996 7048. Email: [info@bsi-global.com](mailto:info@bsi-global.com).

Subscribing members of BSI are kept up to date with standards developments and receive substantial discounts on the purchase price of standards. For details of these and other benefits contact Membership Administration.  
Tel: +44 (0)20 8996 7002. Fax: +44 (0)20 8996 7001.  
Email: [membership@bsi-global.com](mailto:membership@bsi-global.com).

Information regarding online access to British Standards via British Standards Online can be found at <http://www.bsi-global.com/bsonline>.

Further information about BSI is available on the BSI website at <http://www.bsi-global.com>.

### Copyright

Copyright subsists in all BSI publications. BSI also holds the copyright, in the UK, of the publications of the international standardization bodies. Except as permitted under the Copyright, Designs and Patents Act 1988 no extract may be reproduced, stored in a retrieval system or transmitted in any form or by any means – electronic, photocopying, recording or otherwise – without prior written permission from BSI.

This does not preclude the free use, in the course of implementing the standard, of necessary details such as symbols, and size, type or grade designations. If these details are to be used for any other purpose than implementation then the prior written permission of BSI must be obtained.

Details and advice can be obtained from the Copyright & Licensing Manager.  
Tel: +44 (0)20 8996 7070. Fax: +44 (0)20 8996 7553.  
Email: [copyright@bsi-global.com](mailto:copyright@bsi-global.com).