



BSI Standards Publication

<http://www.china-gauges.com/>

Unplasticized poly(vinyl chloride) (PVC-U) profiles for the fabrication of windows and doors — Classification, requirements and test methods

Part 2: PVC-U profiles covered with foils bonded with adhesives

National foreword

This British Standard is the UK implementation of EN 12608-2:2023.

The UK participation in its preparation was entrusted to Technical Committee PRI/21, Testing of plastics.

A list of organizations represented on this committee can be obtained on request to its committee manager.

Contractual and legal considerations

This publication has been prepared in good faith, however no representation, warranty, assurance or undertaking (express or implied) is or will be made, and no responsibility or liability is or will be accepted by BSI in relation to the adequacy, accuracy, completeness or reasonableness of this publication. All and any such responsibility and liability is expressly disclaimed to the full extent permitted by the law.

This publication is provided as is, and is to be used at the recipient's own risk.

The recipient is advised to consider seeking professional guidance with respect to its use of this publication.

This publication is not intended to constitute a contract. Users are responsible for its correct application.

© The British Standards Institution 2023
Published by BSI Standards Limited 2023

ISBN 978 0 539 20975 4

ICS 83.140.99; 91.060.50

Compliance with a British Standard cannot confer immunity from legal obligations.

This British Standard was published under the authority of the Standards Policy and Strategy Committee on 31 October 2023.

Amendments/corrigenda issued since publication

Date	Text affected
------	---------------

EUROPEAN STANDARD

EN 12608-2

NORME EUROPÉENNE

EUROPÄISCHE NORM

October 2023

ICS 83.140.99; 91.060.50

English Version

Unplasticized poly(vinyl chloride) (PVC-U) profiles for the
fabrication of windows and doors - Classification,
requirements and test methods - Part 2: PVC-U profiles
covered with foils bonded with adhesives

Profils de poly(chlorure de vinyle) non plastifié (PVC-U) pour la fabrication des fenêtres et des portes - Classification, exigences et méthodes d'essai - Partie 2 : Profils en PVC-U plaxés avec des films collés

Profile aus weichmacherfreiem Polyvinylchlorid (PVC-U) zur Herstellung von Fenstern und Türen - Klassifizierung, Anforderungen und Prüfverfahren - Teil 2: PVC-U-Profil mit kaschierten Folien, die mittels Klebstoff aufgebracht sind

This European Standard was approved by CEN on 14 August 2023.

CEN members are bound to comply with the CEN/CENELEC Internal Regulations which stipulate the conditions for giving this European Standard the status of a national standard without any alteration. Up-to-date lists and bibliographical references concerning such national standards may be obtained on application to the CEN-CENELEC Management Centre or to any CEN member.

This European Standard exists in three official versions (English, French, German). A version in any other language made by translation under the responsibility of a CEN member into its own language and notified to the CEN-CENELEC Management Centre has the same status as the official versions.

CEN members are the national standards bodies of Austria, Belgium, Bulgaria, Croatia, Cyprus, Czech Republic, Denmark, Estonia, Finland, France, Germany, Greece, Hungary, Iceland, Ireland, Italy, Latvia, Lithuania, Luxembourg, Malta, Netherlands, Norway, Poland, Portugal, Republic of North Macedonia, Romania, Serbia, Slovakia, Slovenia, Spain, Sweden, Switzerland, Türkiye and United Kingdom.



EUROPEAN COMMITTEE FOR STANDARDIZATION
COMITÉ EUROPÉEN DE NORMALISATION
EUROPÄISCHES KOMITEE FÜR NORMUNG

CEN-CENELEC Management Centre: Rue de la Science 23, B-1040 Brussels

Contents

European foreword	4
1 Scope.....	5
2 Normative references.....	5
3 Terms and definitions.....	6
4 Classifications	6
4.1 General.....	6
4.2 Classification of main base profiles according to the wall thickness of the external walls.	7
4.3 Classification of main base profiles according to the resistance to impact by falling mass	7
4.4 Classification of base profile materials according to the resistance to artificial weathering	7
4.5 Classification of foils according to the resistance to artificial weathering.....	7
5 Requirements for base profiles	7
5.1 Base profiles in conformance with EN 12608-1.....	7
5.2 Other base profiles.....	7
5.2.1 Materials	7
5.2.2 Appearance	9
5.2.3 Dimensions and tolerances of main base profiles	9
5.2.4 Linear weight of the main base profiles	9
5.2.5 Heat reversion	10
5.2.6 Resistance to impact by falling mass of the main base profiles.....	10
6 Requirements for foils	10
6.1 General.....	10
6.2 Appearance	10
6.3 Resistance to artificial weathering.....	10
6.4 Solar direct reflectance.....	11
6.5 Resistance to cross cut (only for lacquered foils)	11
7 Requirements for adhesive systems.....	11
7.1 General.....	11
7.2 Adhesion of the foil.....	11
7.3 Adhesion of the foil after hydrolytic/thermolytic storage	11
8 Requirements for laminated profiles.....	11
8.1 General.....	11
8.2 Appearance	11
8.3 Deviation from straightness of the laminated main profiles.....	12
8.4 Behaviour after heat storage	12
8.4.1 General.....	12
8.4.2 Assessment of material properties and extrusion process	12
8.4.3 Assessment of the lamination process	12
8.5 Peel strength.....	12
8.6 Strength of welded corners and T-joints of laminated main profiles.....	13
9 Test methods	13
9.1 Visual inspection.....	13
9.2 Determination of peel strength after hydrolytic/thermolytic storage	13

9.2.1	Principle.....	13
9.2.2	Apparatus and materials	13
9.2.3	Preparation of the test specimens.....	14
9.2.4	Storage and reconditioning	14
9.2.5	Determination of the peel strength.....	14
9.2.6	Test report	14
10	Traceability.....	15
Annex A	(normative) Requirements for materials of other base profiles than described in EN 12608-1.....	16
A.1	General	16
A.2	Preparation of test specimens.....	18
A.2.1	General	18
A.2.2	Preparation of pressed plates.....	18
A.2.3	Material properties.....	18
Annex B	(informative) Guidance for the selection of a suitable class for the foil according to 4.5 based on the climatic condition at the intended installation site.....	19
B.1	General	19
B.2	Natural irradiation.....	19
B.3	Köppen-Geiger climate classification.....	22
Annex C	(normative) Determination of the reflection behaviour of foils by spectral analysis.....	24
C.1	Principles.....	24
C.2	Apparatus	24
C.2.1	UV/VIS/NIR-Spectrophotometer, used to establish reflection-spectra, with the following specifications:	24
C.3	Preparation of test specimens	24
C.4	Determination of the solar direct reflectance.....	25
C.5	Test report	25
	Bibliography	26

European foreword

This document (EN 12608-2:2023) has been prepared by Technical Committee CEN/TC 249 “Plastics”, the secretariat of which is held by SIS.

This European Standard shall be given the status of a national standard, either by publication of an identical text or by endorsement, at the latest by April 2024, and conflicting national standards shall be withdrawn at the latest by April 2024.

Attention is drawn to the possibility that some of the elements of this document may be the subject of patent rights. CEN shall not be held responsible for identifying any or all such patent rights.

The EN 12608 series, *Unplasticized poly(vinyl chloride) (PVC-U) profiles for the fabrication of windows and doors — Classification, requirements and test methods*, currently consists of the following parts:

- *Part 1: Non-coated PVC-U profiles with light coloured surfaces*
- *Part 2: PVC-U profiles covered with foils bonded with adhesives*
- *Part 3: PVC-U profiles covered with paint (in preparation)*
- *Part 4: PVC-U profiles with thermo-laminated foils (in preparation)*
- *Part 5: PVC-U profiles with coextruded coloured top-layer (in preparation)*

Any feedback and questions on this document should be directed to the users' national standards body. A complete listing of these bodies can be found on the CEN website.

According to the CEN-CENELEC Internal Regulations, the national standards organisations of the following countries are bound to implement this European Standard: Austria, Belgium, Bulgaria, Croatia, Cyprus, Czech Republic, Denmark, Estonia, Finland, France, Germany, Greece, Hungary, Iceland, Ireland, Italy, Latvia, Lithuania, Luxembourg, Malta, Netherlands, Norway, Poland, Portugal, Republic of North Macedonia, Romania, Serbia, Slovakia, Slovenia, Spain, Sweden, Switzerland, Türkiye and the United Kingdom.

1 Scope

This document specifies the classifications, requirements and test methods for unplasticized poly(vinyl chloride) (PVC-U) profiles covered with foils designed for external uses bonded with adhesives which are intended to be used for the fabrication of windows and doors.

NOTE 1 For editorial reasons, in this document, the term “window” is used for window and door.

NOTE 2 For the purpose of production control, test methods other than those specified in this document can be used.

2 Normative references

The following documents are referred to in the text in such a way that some or all of their content constitutes requirements of this document. For dated references, only the edition cited applies. For undated references, the latest edition of the referenced document (including any amendments) applies.

EN 410, *Glass in building — Determination of luminous and solar characteristics of glazing*

EN 478, *Plastics — Poly(vinyl chloride) (PVC) based profiles — Determination of the appearance after exposure at 150 °C*

EN 479, *Plastics — Poly(vinyl chloride) (PVC) based profiles — Determination of heat reversion*

EN 513, *Plastics — Poly(vinylchloride) (PVC) based profiles — Determination of the resistance to artificial weathering*

EN 514, *Plastics — Poly(vinyl chloride) (PVC) based profiles — Determination of the strength of welded corners and T-joints*

EN 12608-1:2016+A1:2020, *Unplasticized poly(vinyl chloride) (PVC-U) profiles for the fabrication of windows and doors — Classification, requirements and test methods — Part 1: Non-coated PVC-U profiles with light coloured surfaces*

EN 17271, *Plastics — Poly(vinyl chloride) (PVC) based profiles — Determination of the peel strength of profiles laminated with foils*

EN 17508, *Plastics — Unplasticized poly(vinyl chloride) (PVC-U) profiles for the fabrication of windows and doors — Terminology of PVC based materials*

EN 20105-A02, *Textiles — Tests for colour fastness — Part A02: Grey scale for assessing change in colour (ISO 105-A02)*

EN ISO 105-A01:2010, *Textiles — Tests for colour fastness — Part A01: General principles of testing (ISO 105-A01:2010)*

EN ISO 178, *Plastics — Determination of flexural properties (ISO 178)*

EN ISO 179-1, *Plastics — Determination of Charpy impact properties — Part 1: Non-instrumented impact test (ISO 179-1)*

EN ISO 306, *Plastics — Thermoplastic materials — Determination of Vicat softening temperature (VST) (ISO 306)*

EN ISO 2409, *Paints and varnishes — Cross-cut test (ISO 2409)*

EN ISO 4892-2:2013, *Plastics — Methods of exposure to laboratory light sources — Part 2: Xenon-arc lamps (ISO 4892-2:2013)*

EN ISO 8256, *Plastics — Determination of tensile-impact strength (ISO 8256)*

EN ISO/CIE 11664-4, *Colorimetry — Part 4: CIE 1976 L*a*b* colour space (ISO/CIE 11664-4)*

EN ISO 21306-2:2019, *Plastics — Unplasticized poly(vinyl chloride) (PVC-U) moulding and extrusion materials — Part 2: Preparation of test specimens and determination of properties (ISO 21306-2:2019)*

3 Terms and definitions

For the purposes of this document the terms and definitions given in EN 12608-1 (except for material definitions), EN 17508 and the following apply.

ISO and IEC maintain terminological databases for use in standardization at the following addresses:

- IEC Electropedia: available at <https://www.electropedia.org/>
- ISO Online browsing platform: available at <https://www.iso.org/obp>

3.1

base profile

profile without covering foil intended for lamination

3.2

laminated profile

profile covered with foil

3.3

foil

plastics layer for external uses intended to cover surfaces of a base profile

Note 1 to entry: Foil can be lacquered or not.

3.4

base layer of the foil

layer of the foil with or without further surface treatment which is in contact with the adhesive system

3.5

adhesive system

material or combination of materials which assures the adhesion of the foil on the base profile

EXAMPLES Primer and glue; primerless treatment of the surface (e.g. plasma treatment) and glue.

4 Classifications

4.1 General

The selection of appropriate classes necessary to fulfil national requirements may be given in the national foreword of this document.

4.2 Classification of main base profiles according to the wall thickness of the external walls

For the wall thickness of the external walls, the main base profiles shall be classified according to EN 12608-1:2016+A1:2020, 4.4 (Figure 2 and Table 3).

4.3 Classification of main base profiles according to the resistance to impact by falling mass

For the resistance to impact by falling mass, the main base profiles shall be classified according to EN 12608-1:2016+A1:2020, 4.3.

4.4 Classification of base profile materials according to the resistance to artificial weathering

Resistance to artificial weathering of base profile materials shall be determined according to Annex A. There are two possibilities for the classification of base profile materials which are used for the profile's surface according to the resistance to artificial weathering:

- a) for UV resistant materials (UVM) classification according to climatic zones conforming to EN 12608-1:2016+A1:2020, 4.2, applies (classes M and S);
- b) for reduced-UV resistant materials (RUVM) the class "RUVM" applies.

4.5 Classification of foils according to the resistance to artificial weathering

The resistance to artificial weathering of foils shall be classified according to Table 1 after testing according to 6.3.

For guidance regarding the selection of the appropriate foil class, see Annex B.

Table 1 — Classification of foils according to the resistance to artificial weathering

Class	M 8	M 12	M 20	M 30
Radiant exposure in wavelength range (300 to 800) nm	8 GJ/m ²	12 GJ/m ²	20 GJ/m ²	30 GJ/m ²

5 Requirements for base profiles

5.1 Base profiles in conformance with EN 12608-1

If the base profile is in accordance with EN 12608-1, no further requirements for the base profile apply.

5.2 Other base profiles

5.2.1 Materials

All requirements for materials of other base profiles than described in 5.1 are given in Annex A. To fulfil requirements according to Annex A materials of type rPVC may be re-stabilized and/or enhanced with additives (e.g. modifiers, pigments, lubricants) before use.

The use of permitted materials on surfaces of profiles is given in Table 2 and Figure 1.

It is permitted to use a reduced-UV resistant virgin material (RUVM) on the surface when the sight surfaces of the profile are covered with foil (see Table 2).

If PVC-U recyclate (rPVC) or non-UV resistant virgin material (NUVM) is used for the base profile the following shall apply:

- a) these materials may be used for the core of a profile, where any visible surfaces are completely covered by coextrusion with a virgin material (UVM), an UV resistant internally reused material (IRM) or a reduced-UV resistant virgin material (RUVM);
- b) for sight surfaces, the minimum value of thickness of the coextruded surface layer shall be 0,5 mm;
- c) for non-sight visible surfaces, the minimum thickness of the coextruded surface layer shall be 0,2 mm;
- d) there is no requirement for minimum thickness of the coextruded surface layer: 1) at the inside surface of grooves with an entry width ≥ 1 mm (see Figure 1); 2) for grooves protected from UV radiation (e.g. grooves equipped with gasket) regardless of their width;
- e) the thickness of the coextruded layer is determined according to EN 12608-1:2016+A1:2020, 6.4.

Table 2 — Use of materials on surfaces of profiles

Permitted material	Sight surface	Non-sight visible surface	Non-visible surface
UV resistant virgin material (UVM)	Yes	Yes	Yes
UV resistant internally reused material (IRM)	Yes	Yes	Yes
Reduced-UV resistant virgin material (RUVM)	Yes (if intended to be covered with foil)	Yes	Yes
Non-UV resistant virgin material (NUVM)	No	No	Yes
PVC-U recyclate (rPVC)	No	No	Yes

Dimensions in millimetres

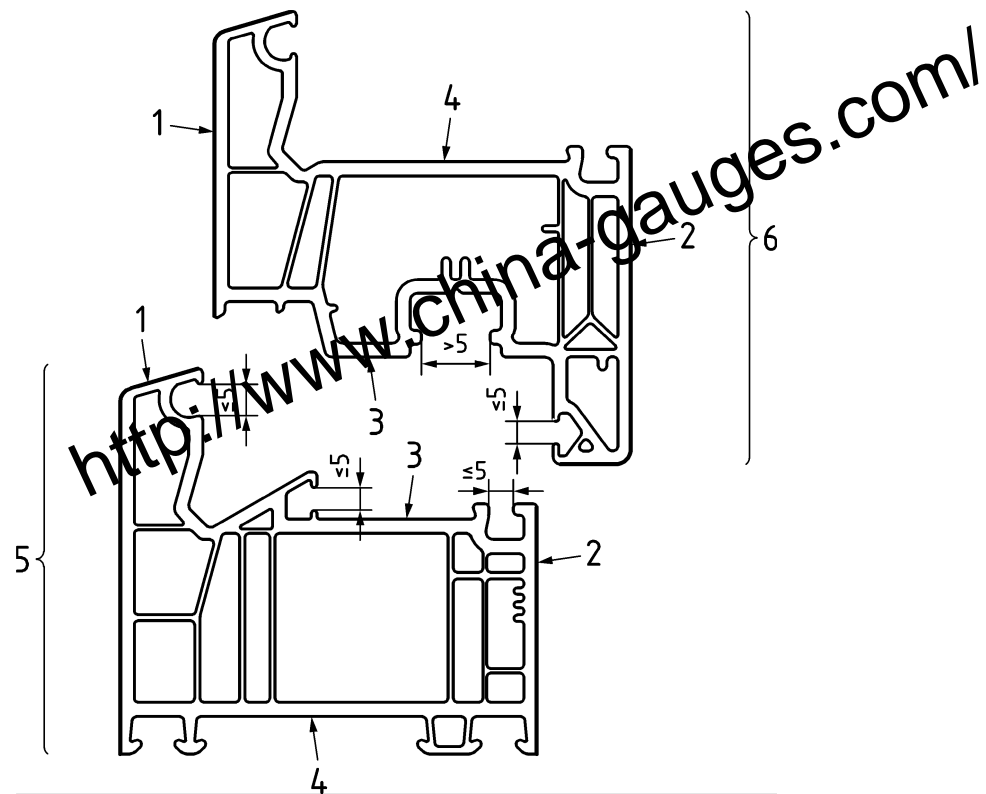

Key

- 1 + 2 sight surfaces
- 3 non-sight visible surface
- 4 non-visible surface
- 5 frame profile
- 6 sash/casement profile

NOTE Dimensions of grooves are given as examples only.

Figure 1 — Designation of profile surfaces by the example of frame profile and sash profile

5.2.2 Appearance

The surfaces of the base profile shall be smooth and free from pitting, impurities, cavities and other surface defects when viewed in accordance with 9.1. The appearance of the surface of the foiled profile shall not be adversely affected by the base profile.

The edges of the base profiles shall be clean and burr-free.

5.2.3 Dimensions and tolerances of main base profiles

Requirements concerning dimensions and tolerances of the main base profile shall be the same as for main base profiles according to 5.1.

5.2.4 Linear weight of the main base profiles

Requirements concerning the linear weight of the main base profiles shall be the same as for main base profiles according to 5.1.

5.2.5 Heat reversion

5.2.5.1 Main base profile

Requirements concerning heat reversion for main base profiles shall be the same as for main base profiles according to 5.1.

5.2.5.2 Auxiliary base profiles

Requirements concerning heat reversion for auxiliary base profiles shall be the same as for auxiliary base profiles according to 5.1.

In addition, for false-mullion-profiles affecting the air tightness and water tightness of the window, the heat reversion shall be $\leq 2,0$ % when tested in accordance with EN 479.

5.2.6 Resistance to impact by falling mass on the main base profiles

Requirements concerning resistance to impact by falling mass shall be the same as for base profiles according to 5.1.

6 Requirements for foils

6.1 General

The foil shall be defined and appropriate to be laminated to PVC-U window profiles.

The foil shall be designed for external use.

6.2 Appearance

The surface of the foil may be smooth, structured or grained. When viewed in accordance with 9.1 the foil shall have a uniform appearance concerning colour, gloss and embossing. No cracks, holes, blisters or other defects shall occur.

6.3 Resistance to artificial weathering

The test specimens shall be exposed in accordance with EN 513, Method 1 (Type M) during a time period corresponding to the radiant exposure of the relevant class, as defined in Table 1.

NOTE 1 See EN 12608-1:2016+A1:2020, Annex B for calculation method for the time period.

The test specimens can be:

- a) cut from a foiled profile; or
- b) obtained by applying a foil to a PVC substrate by suitable means, e.g. double-sided acrylic-based adhesive tape.

Specimen holder shall be according to EN ISO 4892-2:2013, 4.6. The type of specimen holder used (backed or open framed) shall be stated in the test report.

NOTE 2 The type of the specimen holder can have an influence on the specimen surface temperature.

After the exposure, the foil shall satisfy the following requirements:

- a) when evaluated by a visual assessment using the grey scale as specified in EN 20105-A02, the colour fastness between the unexposed and exposed specimens shall be ≥ 3 ;
- b) when evaluated by a visual assessment using a magnifying factor $20 \times$ the surface of the foil shall show a uniform staining, no spots, blisters or cracks;

c) for lacquered foils only: Class 0 shall be reached in the cross cut test according to EN ISO 2409.

6.4 Solar direct reflectance

Solar direct reflectance shall be tested in accordance with Annex C and calculated according to EN 410.

NOTE Based on the present state of knowledge (without specific justification) the value is usually higher than 20 %. Applications using foils with values below 20 % can be realized according to the recommendations of the profile supplier.

6.5 Resistance to cross cut (only for lacquered foils)

Class 0 shall be reached in the cross cut test according to EN ISO 2409.

7 Requirements for adhesive systems

7.1 General

The adhesive system shall be defined and appropriate to laminate PVC-U window profiles with foils and it shall fulfil the requirements of 7.2 and 7.3. This ensures the fitness for use of the adhesive system depending on the type of foil used.

For testing purposes primers are grouped as follows, if primers are part of the adhesive system:

- a) primers based on methylene chloride, acetone and MEK (methyl ethyl ketone);
- b) low-VOC (volatile organic compounds) primers.

The test result of an adhesive system is valid for:

- the type of foil used for testing; one type is defined as all foils with the same formulation of the base layer and the same construction described by materials, thickness of each layer of the stack and underside coating (e.g. primer) of the foil regardless of the colour;
- if a primer is part of the adhesive system: the group of primers it belongs to as listed above; a primer that cannot be assigned to either of the above two groups shall be tested individually with each adhesive and each foiling type.

7.2 Adhesion of the foil

When tested in accordance with EN 17271 the value for the peel strength shall be $\geq 2,5$ N/mm.

7.3 Adhesion of the foil after hydrolytic/thermolytic storage

The peel strength determined after storage of a laminated profile in a hot and humid climate according to 9.2 shall be $\geq 1,5$ N/mm.

8 Requirements for laminated profiles

8.1 General

On plane visible surfaces, compliance with the parameters specified by the foil and adhesive manufacturers, such as the quantity of adhesive and the primer applied, shall be ensured.

8.2 Appearance

The manufacturer of the foil should define the tolerances regarding the colour of the foil, if applicable.

When viewed in accordance with 9.1, there shall be no significant difference between the corresponding reference sample of the foil and the laminated profile. Surfaces that are permanently invisible when the window is installed are excluded from this requirement.

The colour of the sight-surface of the base profile which is visible after lamination shall have a uniform colour when viewed in accordance with 9.1.

8.3 Deviation from straightness of the laminated main profiles

When measured in accordance with EN 12608-1:2016+A1:2020, 6.2, the deviation from the straightness of the laminated main profile shall be ≤ 1 mm for a length of 1 m.

8.4 Behaviour after heat storage

8.4.1 General

Testing for behaviour after heat storage according to EN 478 is performed to assess both the extrusion of the base profile and the lamination process.

The material properties and extrusion process are tested by heating up to 150 °C. The behaviour of the base profile is in the focus of this examination. Due to substances included in the PVC-U matrix which evaporate at this temperature a blistering between base profile and foil is possible. This phenomenon is not evaluated as a failure.

If such effects occur at 150 °C it is assumed that they are not caused by an incorrect lamination process. This can be assessed by heating up to 120 °C, a temperature which defines a threshold for the characteristics of adhesive and foil only.

Therefore, if the base profile is already tested according to EN 478 successfully the laminated profile needs only to be tested at 120 °C.

8.4.2 Assessment of material properties and extrusion process

When tested in accordance with EN 478, i.e. heat storage at 150 °C, the profiles shall not show any visible signs of damage such as bubbles, cracks, blisters, delamination or separation of surface layers after cooling to room temperature which can be observed with normal or corrected vision and/or by touching the surface.

There shall not be any separation of the laminated foil from the base profile and/or the protective layer from the base layer. If the profile is coextruded, no separation shall occur between different layers.

If the profile fulfils the requirements above concerning the characteristics of the extrusion process and the material but shows blistering between the base profile and the foil and/or between base layer and protective layer, the test shall be repeated according to 8.4.3 with a new sample.

8.4.3 Assessment of the lamination process

When tested in accordance with EN 478 but with a temperature of 120 °C the profiles shall not show any visible signs of damage such as bubbles, cracks, blisters, delamination or separation of surface layers after cooling to room temperature which can be observed with normal or corrected vision and/or by touching the surface.

There may not be any separation of the laminated foil from the base profile and/or the protective layer from the base layer. If the profile is coextruded no separation shall occur between different layers.

8.5 Peel strength

When tested in accordance with EN 17271 the value for the peel strength shall be $\geq 2,5$ N/mm.

8.6 Strength of welded corners and T-joints of laminated main profiles

Testing the strength of welded corners and T-joints proves the weldability of the profile, if required.

Requirements concerning strength of welded corners and T-joints of laminated main profiles shall be the same as for main base profiles according to 5.1. A test according to EN 514 shall be regarded as passed also if a measured force of $\geq 8\,000$ N is reached. The test can also be carried out on base profiles.

NOTE The test results can also be considered as an assessment of weldability of the base profile material.

9 Test methods

9.1 Visual inspection

The appearance shall be evaluated by viewing with normal or corrected vision at a range of 1 m, in 45° north, sky light perpendicular to the surface as specified in EN ISO 105-A01:2010, Clause 14, or with an equivalent artificial source of light.

9.2 Determination of peel strength after hydrolytic/thermolytic storage

9.2.1 Principle

After storage of a laminated profile in a hot and humid climate the peel strength is determined according to EN 17271.

9.2.2 Apparatus and materials

According to EN 17271 and the following.

Climate chamber with the following characteristics:

- airtight;
- electronically adjustable.

Specimen holder with the following characteristics:

- made of an inert material;
- designed in such a way that following is ensured:
 - free air circulation;
 - prevention of water accumulation on the specimens;
 - contact between the specimens shall be excluded.

Figure 2 shows a principal design by way of example.

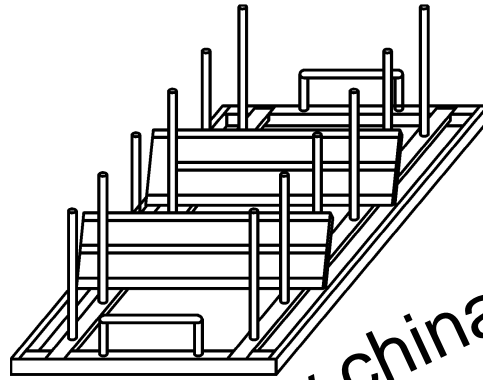

Figure 2 — Principle design of a specimen holder with inserted specimens

9.2.3 Preparation of the test specimens

Samples shall be prepared according to EN 17271.

If method 1 is used, the laminated surface shall not be cut before storing and reconditioning is finished to prevent water collection in the cutting gap.

9.2.4 Storage and reconditioning

Storage in the climate chamber should not start until adhesive system has achieved sufficient strength.

Usually the time to achieve sufficient strength of the adhesive system is recommended by the adhesive manufacturer.

The test specimens are stored in the climate chamber at a temperature of $(70 \pm 2)^\circ\text{C}$ and relative humidity of $(95 \pm 3)\%$ for a time period of 42 days.

After storage the test specimen shall be reconditioned at $(23 \pm 5)^\circ\text{C}$ for at least 24 h and not more than 72 h before testing.

9.2.5 Determination of the peel strength

After heat and humid storage, the peel strength shall be determined according to EN 17271.

9.2.6 Test report

The test report shall be as specified in EN 17271 including the following additional information:

- type of climate chamber used;
- storage conditions (temperature, humidity, time period);
- time period for reconditioning;
- specimen holder used (e.g. photograph);
- preparation of test specimens.

10 Traceability

Traceability according to the following minimum information shall be ensured:

- identification (e.g. name or trade mark) of the company (or companies) responsible for the extrusion and lamination;
- a reference to this document, i.e. EN 12608-2;
- classes according to 4.2, 4.3 and 4.4 of this document, as appropriate;
- in case of rPVC: “contains recovered PVC” or “rPVC” or the following pictogram;



- production code(s) sufficient to enable traceability for the profile extrusion as well as the lamination process including the foil(s) used (e.g. date, machine and/or shift number).

NOTE Information already given by means of identification of the base profile does not need to be repeated for the laminated profile.

For the purpose of traceability means of identification shall be applied to main profiles, at least once every 2 m. If the minimum information is provided by a visibly readable method, it should be on a non-sight surface. For auxiliary profiles means of identification shall be applied either on the profile itself at least once every 2 m or on its packaging.

Annex A
(normative)

Requirements for materials of other base profiles than described in EN 12608-1

A.1 General

Requirements for materials of other base profiles than described in EN 12608-1 are given in Table A.1.

Table A.1 — Requirements for materials of other base profiles than described in EN 12608-1

Property	Test method and type of specimen	Test conditions	Requirements (average values, unless otherwise specified)			
			UVM	RUVM	NUVM	rPVC
Vicat softening temperature VST	EN ISO 306, method B50 Preparation of test specimens according to A.2	temperature rate (50 ± 5) °C/h	average ≥ 75 °C and each individual value ≥ 73 °C	same as UVM	same as UVM	same as UVM
Flexural modulus of elasticity E_f	EN ISO 178 Preparation of test specimens according to A.2	at (23 ± 2) °C	average ≥ 2 200 N/m ² and each individual value ≥ 2 000 N/m ²	same as UVM	same as UVM	same as UVM
Tensile impact strength	EN ISO 8256, type 5 Preparation of test specimens according to A.2	at (23 ± 2) °C	average ≥ 600 kJ/m ² and each single value ≥ 450 kJ/m ²	same as UVM	same as UVM	—
Resistance to artificial weathering	Exposure test method EN 513, method depends on classification Test specimens from sight surfaces of the profiles		Test conditions: for a time period representing five years of outdoor weathering in the climatic zone M or S (calculation method: see EN 12608-1:2016+A1:2020, Annex B)	Test conditions: Method 1 (climate type M) for a time period of 500 h;	—	—

Property	Test method and type of specimen	Test conditions	Requirements (average values, unless otherwise specified)			
			RUVM	NUVM	rPVC	
a) Maximum reduction of Charpy impact strength after artificial weathering	EN ISO 179-1/1fA test specimen taken from the sight surface of a main profile such that the longitudinal direction of the test specimen and profile are the same length (50 ± 1) mm width (6 ± 0,2) mm thickness equal to the wall thickness of the profile Residual width between the notches (3 ± 0,1) mm The support shall have a span of (40 +0,5/0) mm	at (23 ± 2) °C	depending on average measured wall thickness before artificial weathering:	before artificial weathering	maximum reduction	
			≥ 2,8 mm	≥ 55 kJ/m ²	40 %	—
			≥ 2,5 mm and < 2,8 mm	≥ 60 kJ/m ²	30 %	—
			< 2,5 mm	≥ 65 kJ/m ²	20 %	—
b) Colour fastness after artificial weathering	EN ISO/CIE 11664-4		ΔE _{ab} * ≤ 5 and Δb* ≤ 3			
	EN 20105-A02		grey scale fastness grade ≥ 3 a			

a Based on the present state of knowledge this minimum value of the fastness grade is a guiding value. Materials with lower values may be used depending on the installation site and the experience of the profile supplier.

A.2 Preparation of test specimens

A.2.1 General

The test specimens for the determination of the material properties according to A.2.3 shall be taken either from base profiles or from pressed plates prepared according to A.2.2 as indicated. All details of the test specimens used for testing shall be mentioned in the test report.

A.2.2 Preparation of pressed plates

The preparation of the pressed plates shall be in accordance with the procedure given in EN ISO 21306-2:2019, Clause 4, and with the following:

- the material used shall be shredded extruded PVC-U base profiles, granules or powder from virgin material or rPVC-U;
- the differential speed between the two rolls of the mixing mill shall be within the range 1 : 1,4 to 1 : 1,1;
- the pressed plate shall have a thickness of $(4 \pm 0,2)$ mm;
- the cooling of the plate given in EN ISO 21306-2:2019, 4.3, shall be at the nominal rate of 15 K/min.

A.2.3 Material properties

A.2.3.1 Vicat softening temperature

The preparation of test specimens shall be in accordance with EN ISO 306.

For mono-extruded base profiles, the test specimens shall be taken directly from the base profiles or from pressed plates.

For coextruded base profiles, the test specimens shall be taken from pressed plates made from materials separately or from base profiles.

In case of dispute, the test using pressed plates (see A.2.2) is the reference method.

A.2.3.2 Flexural modulus of elasticity

The preparation of test specimens shall be in accordance with EN ISO 178.

For mono-extruded base profiles, the test specimens shall be taken directly from the base profiles or from pressed plates.

For coextruded base profiles, the test specimens shall be taken from pressed plates made from materials separately or from base profiles.

In case of dispute, the test using pressed plates (see A.2.2) is the reference method.

A.2.3.3 Tensile impact strength

The preparation of test specimens shall be in accordance with EN ISO 8256, using type 5 test specimens.

For mono-extruded as well as coextruded profiles the test specimens shall be taken directly from the profiles.

Annex B

(informative)

Guidance for the selection of a suitable class for the foil according to 4.5 based on the climatic condition at the intended installation site

B.1 General

Classification of the foil according to 4.5 reflects the resistance to artificial weathering according to EN 513 for the defined climate M (method 1) and an exposure depending on the test duration. The following explanations are intended to support the selection process.

The durability of a foil mainly depends on climatic conditions described by the parameters temperature, humidity, amount of rain and solar radiation. And all these depend in reality on both the geographical and the object specific installation conditions.

For this guidance average weather conditions are described in B.2 for natural irradiation and B.3 for the Köppen-Geiger climate classification. Both can only provide indicative values.

B.2 Natural irradiation

Figure B.1 shows the yearly sum of global horizontal irradiation (GHI) as the mean value of the years 1996 to 2015.

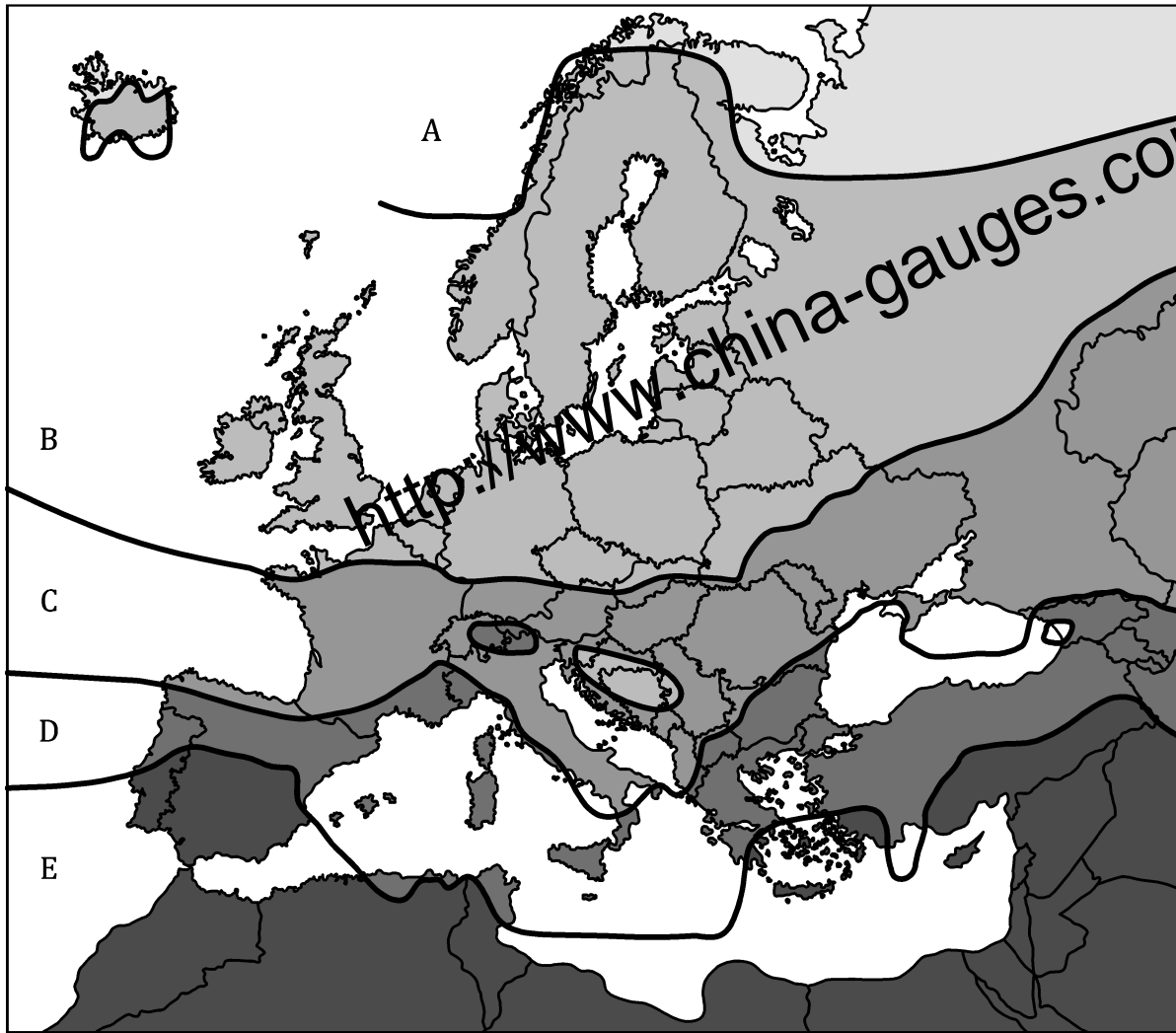

Key





A		< 800 kWh/m ²
B		(800 - 1 100) kWh/m ²
C		(1 100 - 1 400) kWh/m ²
D		(1 400 - 1 700) kWh/m ²
E		> 1 700 kWh/m ²

Figure B.1 — Irradiation map of Europe showing the yearly sum of global horizontal irradiation (1996-2015) [2]

Based on the annual GHI at the intended installation site and the desired proven lifetime of the foil under these conditions an assumption of a corresponding exposure time for determination of the resistance to artificial weathering according to EN 513 is possible.

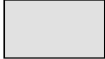
In EN 12608-1:2016+A1:2020, Annex B, the equivalence of the dose of natural solar radiation on the one hand and artificial irradiation in a test according to EN 513 on the other hand is deducted as shown in Table B.1 below.

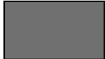
Table B.1 — Global horizontal irradiation and equivalent radiant exposure according to EN 12608-1:2016+A1:2020, Annex B

Natural exposure Global horizontal irradiation (wavelength range 300 nm – 2 500 nm)	Artificial weathering acc. to EN 513 Recommended radiant exposure (wavelength range 300 nm – 800 nm)
$1\,000 \text{ kWh/m}^2 \quad \cong 3,6 \text{ GJ/m}^2$	$1,4 \text{ GJ/m}^2$ for 100 h exposure time ^a
1 kWh/m^2	$0,0014 \text{ GJ/m}^2$
^a Figure based on experience; depending on the device used.	

EXAMPLE for calculation:

Global horizontal irradiation GHI per year [kWh/m^2] = 1 200

Requested proved duration [a] = 15

Total GHI for 15 a [kWh/m^2] = $1\,200 \times 15 = 18\,000$

Recommended equivalent radiation exposure for artificial weathering [GJ/m^2] = $18\,000 \times 0,0014 = 25,2$

This calculation of laboratory exposure time is based only on radiation measurements and excludes other climate influences (temperature, humidity, etc.). To take these into account the Köppen-Geiger Climate Classification can be used (see B.3).

B.3 Köppen-Geiger climate classification

Figure B.2 shows the Köppen-Geiger climate classification map for Europe.

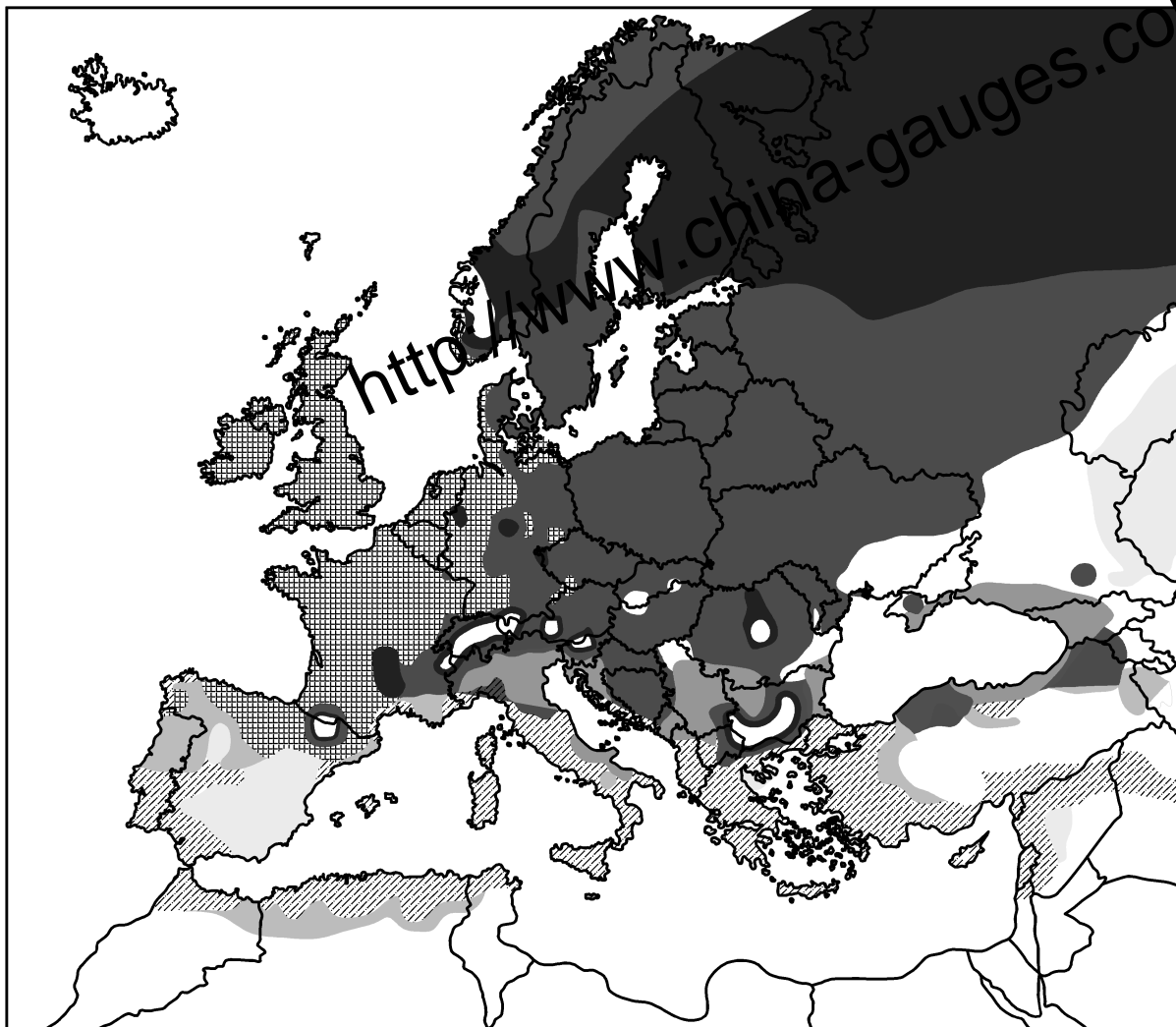



Key

Class B - dry (arid and semiarid) climates

Bsk  cold semi-arid climate (e.g. Valencia, Zaragoza)

Class C - temperate (mesothermal) climates

Csa  hot-summer Mediterranean climate (e.g. Istanbul, Madrid, Izmir, Bursa, Rome)

Csb  warm-summer Mediterranean climate (e.g. Valladolid, Vigo, La Coruna, Porto, Braga)

Cfa  humid subtropical climate (e.g. Belgrade, Milan, Tbilisi, Turin, Skopje)

Cfb  temperate oceanic climate (e.g. London, Paris, Birmingham, Cologne, Amsterdam)

Class D - continental (microthermal) climates

Dfb  humid continental mild summer, wet all year (e.g. Moscow, Berlin, Kiev)

Dfc  subarctic with cool summers and year around rainfall

NOTE Areas shown in white are outside of consideration.

Figure B.2 —Köppen-Geiger climate classification map for Europe [3]

Depending on irradiance, temperature and humidity the appropriated class should be discussed with the foil manufacturer.

<http://www.china-gauges.com/>

Annex C (normative)

Determination of the reflection behaviour of foils by spectral analysis

C.1 Principles

This test method describes a measurement of the solar direct reflectance under laboratory conditions.

The foil is applied onto a white and/or black carrier-material.

The test can also be performed by applying the foil to other kinds of carrier-materials. If other carrier-materials are used they should be specified in the test report.

C.2 Apparatus

C.2.1 UV/VIS/NIR-Spectrophotometer, used to establish reflection-spectra, with the following specifications:

- geometry: Integration-, Ulbricht-sphere (diameter 150 mm);
- sphere-body from or coated with sintered PTFE;
- wavelength range: 300 nm – 2 500 nm;
- reference standard white: sintered PTFE;
- use of a depolarizer;
- angle of incoming ray: 8°;
- appropriate resolution of the spectra necessary;
- in accordance with EN 410.

C.3 Preparation of test specimens

For testing, the foil shall be fixed onto a base plate.

The following applies to the base material:

- a) White: homogeneous white PVC-U plate, which shows $L^* > 92$ (as defined in EN ISO/CIE 11664-4) and solar direct reflectance ≥ 73 % (according to EN 410);
- b) Black: homogeneous black PVC-U plate, coloured by carbon black, which shows a carbon content of $(0,5 \pm 0,1)$ % and solar direct reflectance ≤ 5 % (according to EN 410).

The test samples shall be of suitable size for the spectrometer and shall have a thickness of at least 2 mm. The tested samples shall be completely flat. Base material can be purchased from traders according to the specifications above.

The foil shall be attached onto the carrier material as follows:

- by lamination; or
- by means of an adhesive tape with the following specification:
 - double sided adhesive tape, with no further carrier film;
 - pure-acrylic-adhesive, transparent and colourless;
 - nominal thickness $(90 \pm 10) \mu\text{m}$.

Blisters shall be prevented.

For printed foils (e.g. wood pattern) the sections used for determination of the solar direct reflectance shall be two spots: 1) the spot with the approximately darkest print colour, and 2) the spot with the approximately lightest print colour within a representative section of the print. The result is the mean value for both spots. The chosen section and analysed spots of the print can be documented with a photograph and attached to the test report.

C.4 Determination of the solar direct reflectance

The solar direct reflectance ρ_e shall be determined according to EN 410 for a white and/or a black base material.

C.5 Test report

The test report shall include the following information:

- a) a reference to this document; i.e. EN 12608-2;
- b) description of the base material (material, type and colour);
- c) description of the foil (type and colour, e.g. photograph);
- d) identification of the foil (manufacturer, name of foil, number of article or colour);
- e) the value(s) of ρ_e for the foil on white and/or black base material in % (rounded to a whole number).

Bibliography

- [1] EN 477, *Plastics — Poly(vinyl chloride) (PVC) based profiles — Determination of the resistance to impact of profiles by falling mass*
- [2] <https://www.meteonorm.com>
- [3] <https://www.plantmaps.com>

<http://www.china-gauges.com/>

<http://www.china-gauges.com/>

British Standards Institution (BSI)

BSI is the national body responsible for preparing British Standards and other standards-related publications, information and services.

BSI is incorporated by Royal Charter. British Standards and other standardization products are published by BSI Standards Limited.

About us

We bring together business, industry, government, consumers, innovators and others to shape their combined experience and expertise into standards-based solutions.

The knowledge embodied in our standards has been carefully assembled in a dependable format and refined through our open consultation process. Organizations of all sizes and across all sectors choose standards to help them achieve their goals.

Information on standards

We can provide you with the knowledge that your organization needs to succeed. Find out more about British Standards by visiting our website at bsigroup.com/standards or contacting our Customer Services team or Knowledge Centre.

Buying standards

You can buy and download PDF versions of BSI publications, including British and adopted European and international standards, through our website at bsigroup.com/shop, where hard copies can also be purchased.

If you need international and foreign standards from other Standards Development Organizations, hard copies can be ordered from our Customer Services team.

Copyright in BSI publications

All the content in BSI publications, including British Standards, is the property of and copyrighted by BSI or some person or entity that owns copyright in the information used (such as the international standardization bodies) and has formally licensed such information to BSI for commercial publication and use.

Save for the provisions below, you may not transfer, share or disseminate any portion of the standard to any other person. You may not adapt, distribute, commercially exploit or publicly display the standard or any portion thereof in any manner whatsoever without BSI's prior written consent.

Storing and using standards

Standards purchased in soft copy format:

- A British Standard purchased in soft copy format is licensed to a sole named user for personal or internal company use only.
- The standard may be stored on more than one device provided that it is accessible by the sole named user only and that only one copy is accessed at any one time.
- A single paper copy may be printed for personal or internal company use only.

Standards purchased in hard copy format:

- A British Standard purchased in hard copy format is for personal or internal company use only.
- It may not be further reproduced – in any format – to create an additional copy. This includes scanning of the document.

If you need more than one copy of the document, or if you wish to share the document on an internal network, you can save money by choosing a subscription product (see 'Subscriptions').

Reproducing extracts

For permission to reproduce content from BSI publications contact the BSI Copyright and Licensing team.

Subscriptions

Our range of subscription services are designed to make using standards easier for you. For further information on our subscription products go to bsigroup.com/subscriptions.

With **British Standards Online (BSOL)** you'll have instant access to over 55,000 British and adopted European and international standards from your desktop. It's available 24/7 and is refreshed daily so you'll always be up to date.

You can keep in touch with standards developments and receive substantial discounts on the purchase price of standards, both in single copy and subscription format, by becoming a **BSI Subscribing Member**.

PLUS is an updating service exclusive to BSI Subscribing Members. You will automatically receive the latest hard copy of your standards when they're revised or replaced.

To find out more about becoming a BSI Subscribing Member and the benefits of membership, please visit bsigroup.com/shop.

With a **Multi-User Network Licence (MUNL)** you are able to host standards publications on your intranet. Licences can cover as few or as many users as you wish. With updates supplied as soon as they're available, you can be sure your documentation is current. For further information, email cservices@bsigroup.com.

Revisions

Our British Standards and other publications are updated by amendment or revision.

We continually improve the quality of our products and services to benefit your business. If you find an inaccuracy or ambiguity within a British Standard or other BSI publication please inform the Knowledge Centre.

Useful Contacts

Customer Services

Tel: +44 345 086 9001

Email: cservices@bsigroup.com

Subscriptions

Tel: +44 345 086 9001

Email: subscriptions@bsigroup.com

Knowledge Centre

Tel: +44 20 8996 7004

Email: knowledgecentre@bsigroup.com

Copyright & Licensing

Tel: +44 20 8996 7070

Email: copyright@bsigroup.com

BSI Group Headquarters

389 Chiswick High Road London W4 4AL UK